



Compact Cylinder: Standard/ Double Acting Single Rod NCQ2 / CQ2 Series

ø12, ø16, ø20, ø25, ø32, ø40, ø50, ø63, ø80, ø100

How To Order

W/ Auto Switch NCQ2 **B H 20 F 30 D C**

NCQ2 **B H 20 F 30 D C**

W/ Auto Switch (built-in magnet) **NCDQ2 B H 20 F 30 D C A73 S**

Mounting

B	Through hole	F	Rod side flange
A	Both ends tapped	G	Head side flange
L	Foot	D	Double Clevis

Style

-	Air pressure
H	See note 1) Air Hydro

Note 1) The available air-hydro bore sizes: ø20~ø100, CQ2 only.

Bore Size

12	12mm (1/2" Nom.)	40	40mm (1-1/2" Nom.)
16	16mm (5/8" Nom.)	50	50mm (2" Nom.)
20	20mm (3/4" Nom.)	63	63mm (2-1/2" Nom.)
25	25mm (1" Nom.)	80	80mm (3-1/4" Nom.)
32	32mm (1-1/4" Nom.)	100	100mm (4" Nom.)

Piping

-	Threaded ports
F	See note 2) Built-in one-touch fitting

Note 2) Available built-in one touch fitting bore size: ø32~ø63.
Not applicable for Air-Hydro type CQ2

Cylinder Stroke (mm)
Please refer to p.3 for standard strokes

Action

D	Double
---	--------

Preferred Option Program

Auto Switch

-	2 pcs.
S	1 pcs.
n	n pcs.

Auto Switch Capability

-	Without Auto Switch
---	---------------------

Auto Switch Specifications

Type	Autoswitch		Indicator light	Wire (Output type)	Load Voltage		
	Perpendicular entry	In-line entry			DC	AC	
Reed switch	—	A76H	Yes	3 Wire	—	5V	
	A72	A72H			—	200V	
	A73	A73H			12V	100V	
	A80	A80H	No	2 Wire	24V	5V, 12V	
	A73C	—				12V	—
	A80C	—				5V, 12V	24V
	A79W	—				—	—
Solid State Switch	F7NV	F79	Yes	3 Wire NPN	24V	5V, 12V	
	F7PV	F7P		3 Wire PNP		—	
	F7BV	J79		2 Wire	12V		
	J79C	—		3 Wire NPN	24V	5V, 12V	
	F7NVV	F79W					
	—	F7PW					
	F7BVV	J79W		2 Wire	12V		
	—	F7BAL		3 Wire NPN	24V	5V, 12V	
	—	F7NTL					
	—	F79F					
	—	F7LF					

• Load length 0.5m.....Std. Connector A80C 5m.....Z Connector A80CZ
3m.....L A80CL No lead.....N A80CN

Body Option

-	Std. (Female thread)
C	Note 3) W/ rubber cushion
M	Male thread
F	Head end boss

* Body option combination is available such as CM, FC, FM, and FCM.
Note 3) W/ Rubber cushion is not available for the air-hydraulic type.

Mounting Kits

Bore Size (mm)	Note 4) Foot	Flange	Note 6) Double clevis
12	(N)CQ-L012	(N)CQ-F012	(N)CQ-D012
16	(N)CQ-L016	(N)CQ-F016	(N)CQ-D016
20	(N)CQ-L020	(N)CQ-F020	(N)CQ-D020
25	(N)CQ-L025	(N)CQ-F025	(N)CQ-D025
32	(N)CQ-L032	(N)CQ-F032	(N)CQ-D032
40	(N)CQ-L040	(N)CQ-F040	(N)CQ-D040
50	(N)CQ-L050	(N)CQ-F050	(N)CQ-D050
63	(N)CQ-L063	(N)CQ-F063	(N)CQ-D063
80	(N)CQ-L080	(N)CQ-F080	(N)CQ-D080
100	(N)CQ-L100	(N)CQ-F100	(N)CQ-D100

Note 4) If foot bracket is required for a cylinder, order a pair

Note 5) Each bracket comes with the following accessories;
Foot / Flange; Body mounting bolt
Double clevis; Clevis pin, Axis C style snap ring,
Body mounting bolt

Note 6) The double-clevis is packaged with clevis pin and snap ring.



Standard /
Double Acting Single rod

(N)CQ2 Series

Model



Bore Size		12	16	20	25	32	40	50	63	80	100	
Air-Pressure Type	Mounting	Through hole (std)	●	●	●	●	●	●	●	●	●	
		Both ends tapped	●	●	●	●	●	●	●	●	●	
	Built-In Magnet		●	●	●	●	●	●	●	●	●	
	Piping Method	Threaded PT or NPT	M5x 0.8	M5x 0.8	M5x 0.8	M5x 0.8	Note 1 M5x 0.8 1/8	1/8	1/4	1/4	3/8	3/8
		Built-In One Touch Fitting	-	-	-	-	Note 2 6/4	6/4	8/6	8/6	-	-
	Rod End Male Thread		●	●	●	●	●	●	●	●	●	●
W/Rubber Cushion		●	●	●	●	●	●	●	●	●	●	
W/Head End boss		●	●	●	●	●	●	●	●	●	●	
Air-Hydro Type	Mounting	Through hole (std)	-	-	●	●	●	●	●	●	●	
		Both ends tapped	-	-	●	●	●	●	●	●	●	
	Built-In Magnet		-	-	●	●	●	●	●	●	●	
	Piping Method	Threaded PT or NPT	-	-	M5x 0.8	M5x 0.8	Note 1 M5x 0.8 1/8	1/8	1/4	1/4	3/8	3/8
		Rod End Male Thread	-	-	●	●	●	●	●	●	●	●
	W/ Head End boss		-	-	●	●	●	●	●	●	●	●

Note 1) In cases without autoswitch, only 5 stroke uses M5x0.8

Note 2) In case of built-in fitting, the external tube dimension for ø 32, 5 stroke and 10 stroke are the same.

Standard Specifications

Double acting/
Single rod

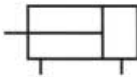

Head end boss

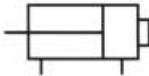

Model	Air Pressure (Non-Lube)	Air-hydraulic
Media	Air	Hydraulic oil
Proof Pressure	217psi {15.3kgf/cm ² }	
Max. Operating Pressure	145psi {10.2kgf/cm ² }	
Ambient and Media temp.	15~160°F{-10°C~+70°C} (At freezing temp. air must be dry)	
Rubber cushion	None	-
Rod end thread	Female Thread (std.)	
Rod end thread tolerance	JIS Class II	
Stroke Length tolerance	+1.0 0 mm	
Mounting	Through hole (std.)	
Piston Speed	2~20in/s (50~500mm/s)	.002~8 in/s(0.5~200mm/s)

Min. Operating Pressure

psi

Bore size	12	16	20	25	32	40	50	63	80	100
Air pressure type (non-lube)	10.15	10.15	7.25	7.25	7.25	7.25	7.25	7.25	7.25	7.25
Air-hydro	-	-	26.1	26.1	26.1	14.5	14.5	14.5	14.5	14.5

Cautions

- When mounting, completely flush piping and be careful that dust and chips do not enter the cylinder.
- The Piston rod load should always be aligned with the cylinder axis.
 - Cylinder installation requires accurate alignment.
 - When used as a stopper, avoid side loading of the piston rod.
- Prevent damage to the piston rod. A damaged piston rod will lead to damage of the rod seal and result in leakage.

Standard stroke

Air pressure type (non-lube)		mm	Air-Hydro		mm
Bore size	Standard stroke		Bore size	Standard stroke	
12,16	5,10,15,20,25,30		20,25	5,10,15,20,25,30,35,40,45,50	
20,25	5,10,15,20,25,30,35,40,45,50		32,40	5,10,15,20,25,30,35,40,45,50,75,100	
32,40	5,10,15,20,25,30,35,40,45,50,75,100		50,63	10,15,20,25,30,35,40,45,50,75,100	
50,63	10,15,20,25,30,35,40,45,50,75,100		80,100	45,50,75,100	

• Available intermediate stroke.

Intermediate strokes in 1mm increments are available by installing a spacer into the STD. stroke cylinder. Contact an SMC representative for ø40-ø100 intermediate stroke cylinder with bumper. Example] CQ2B50-57D can be made by installing a 18 mm (w)spacer into the std. cylinder CQ2B50-75D. 5mm Incremental Stroke (spacers) done as standard.

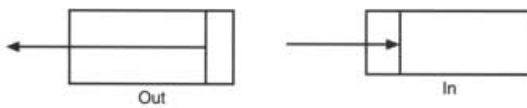

Weight/Double acting: Single rod type

lbs

Double Acting Single Rod lbf

Bore size	Rod direction	Operating pressures PSI		
		50	75	100
12	OUT	8.7	13.1	17.5
	IN	6.6	9.8	13.1
16	OUT	15.6	23.4	31.2
	IN	11.7	17.5	23.4
20	OUT	24.3	36.5	48.6
	IN	18.2	27.3	36.5
25	OUT	38.0	57.0	76.0
	IN	29.3	43.9	58.5
32	OUT	62.3	93.5	125
	IN	46.8	70.1	93.5
40	OUT	97.4	146	195
	IN	81.8	123	164
50	OUT	152	228	304
	IN	128	192	256
63	OUT	242	362	483
	IN	217	326	434
80	OUT	390	584	779
	IN	352	527	703
100	OUT	609	913	1217
	IN	554	831	1108

Bore size	Stroke											
	5	10	15	20	25	30	35	40	45	50	75	100
12	0.088	0.104	0.119	0.135	0.150	0.165	-	-	-	-	-	-
16	0.135	0.159	0.183	0.207	0.232	0.256	-	-	-	-	-	-
20	0.021	0.247	0.291	0.335	0.381	0.426	0.470	0.516	0.560	0.604	-	-
25	0.260	0.306	0.353	0.399	0.448	0.494	0.540	0.587	0.633	0.681	-	-
32	0.346	0.397	0.445	0.496	0.547	0.595	0.644	0.697	0.747	0.798	1.15	1.40
40	0.600	0.648	0.697	0.745	0.794	0.842	0.891	0.939	0.988	1.04	1.37	1.62
50	-	0.884	0.968	1.05	1.13	1.21	1.30	1.38	1.46	1.55	2.11	2.43
63	-	1.43	1.51	1.60	1.69	1.78	1.87	1.96	2.04	2.13	2.77	3.23
80	-	3.18	3.38	3.58	3.78	3.98	4.18	4.38	4.58	4.78	6.24	7.27
100	-	4.87	5.10	5.34	5.57	5.80	6.04	6.27	6.50	6.74	8.38	9.52

Weight Adder

lbs.

Bore size	12	16	20	25	32	40	50	63	80	100
Both ends tapped	0.004	0.004	0.013	0.013	0.013	0.013	0.013	0.042	0.099	0.099
Rod end M thread	Thread	0.003	0.007	0.013	0.026	0.057	0.060	0.117	0.117	0.265
	Nut	0.002	0.004	0.009	0.018	0.037	0.037	0.071	0.071	0.108
Head end boss	0.002	0.003	0.004	0.007	0.011	0.015	0.029	0.055	0.099	0.212
W/ rubber cushion	0.000	0.000	-0.004	-0.007	-0.007	-0.015	-0.020	-0.040	-0.068	-0.123
W/ one touch fitting	-	-	-	-	0.026	0.026	0.046	0.046	-	-
Foot mounting*	0.121	0.148	0.362	0.410	0.315	0.342	0.536	0.714	1.535	2.342
Rod side flange*	0.126	0.152	0.306	0.355	0.397	0.472	0.822	1.233	2.328	3.010
Head side flange*	0.119	0.143	0.293	0.335	0.364	0.437	0.767	1.177	2.242	2.886
Double clevis**	0.071	0.086	0.194	0.271	0.333	0.432	0.867	1.222	2.445	4.161

*(incl. mounting bolt) ** (incl. pin, snap ring, bolt)

How to obtain the total weight (lbs)

NCQ2D32-20DCM

Std wt.:	NCQ2B32-20D	.496
Wt. adder:	Mounting end (both) tap	0.013
	Rod end M thread	.057
	W/ rubber cushion	-0.007
	Double clevis	.333
	Total	.892

Mounting Bolt For (N)CQ2

Special long mounting bolt for through hole mounting is available as an option.
 How to Order:
 Specify the required bolts
 Example) Bolt M3x35L 4pcs.

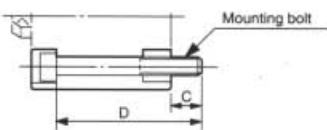

Thread	Pitch
M3	0.5
M5	0.8
M6	1.0
M8	1.25
M10	1.5

Model	C	D	Mounting bolt
(N)CQ2B12-5D	6.5	25	M3x25L
-10D		30	x30L
-15D		35	x35L
-20D		40	x40L
-25D		45	x45L
-30D		50	x50L
(N)CQ2B16-5D	5	25	M3x25L
-10D		30	x30L
-15D		35	x35L
-20D		40	x40L
-25D		45	x45L
-30D		50	x50L
(N)CQ2B20-5D	7.5	25	M5x25L
-10D		30	x30L
-15D		35	x35L
-20D		40	x50L
-25D		45	x45L
-30D		50	x50L
(N)CQ2B25-5D	9.5	30	M5x30L
-10D		35	x35L
-15D		40	x40L
-20D		45	x45L
-25D		50	x50L
-30D		55	x55L
(N)CQ2B32-5D	9	30	M5x30L
-10D		35	x35L
-15D		40	x40L
-20D		45	x45L
-25D		50	x50L
-30D		55	x55L
(N)CQ2B40-5D	7.5	35	M5x35L
-10D		40	x40L
-15D		45	x45L
-20D		50	x50L
-25D		55	x55L
-30D		60	x60L
(N)CQ2B50-10D	12.5	45	M6x45L
-15D		50	x50L
-20D		55	x55L
-25D		60	x60L
-30D		65	x65L
-35D		70	x70L
(N)CQ2B63-10D	14.5	50	M8x50L
-15D		55	x55L
-20D		60	x60L
-25D		65	x65L
-30D		70	x70L
-35D		75	x75L
(N)CQ2B80-10D	15	55	M10x55L
-15D		60	x60L
-20D		65	x65L
-25D		70	x70L
-30D		75	x75L
-35D		80	x80L
(N)CQ2B100-10D	15.5	65	M10x65L
-15D		70	x70L
-20D		75	x75L
-25D		80	x80L
-30D		85	x85L
-35D		90	x90L

Model	C	D	Mounting bolt
(N)CQ2B32-5D	9	30	M5x30L
-10D		35	x35L
-15D		40	x40L
-20D		45	x45L
-25D		50	x50L
-30D		55	x55L
(N)CQ2B40-5D	7.5	35	M5x35L
-10D		40	x40L
-15D		45	x45L
-20D		50	x50L
-25D		55	x55L
-30D		60	x60L
(N)CQ2B50-10D	12.5	45	M6x45L
-15D		50	x50L
-20D		55	x55L
-25D		60	x60L
-30D		65	x65L
-35D		70	x70L
(N)CQ2B63-10D	14.5	50	M8x50L
-15D		55	x55L
-20D		60	x60L
-25D		65	x65L
-30D		70	x70L
-35D		75	x75L
(N)CQ2B80-10D	15	55	M10x55L
-15D		60	x60L
-20D		65	x65L
-25D		70	x70L
-30D		75	x75L
-35D		80	x80L
(N)CQ2B100-10D	15.5	65	M10x65L
-15D		70	x70L
-20D		75	x75L
-25D		80	x80L
-30D		85	x85L
-35D		90	x90L

Model	C	D	Mounting bolt
(N)CQ2B63-10D	14.5	50	M8x50L
-15D		55	x55L
-20D		60	x60L
-25D		65	x65L
-30D		70	x70L
-35D		75	x75L
(N)CQ2B80-10D	15	55	M10x55L
-15D		60	x60L
-20D		65	x65L
-25D		70	x70L
-30D		75	x75L
-35D		80	x80L
(N)CQ2B100-10D	15.5	65	M10x65L
-15D		70	x70L
-20D		75	x75L
-25D		80	x80L
-30D		85	x85L
-35D		90	x90L

Compact Cylinder: Standard / Double Acting Single Rod

Construction / Part List

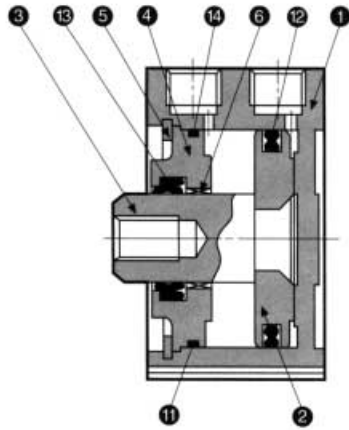

Double Acting / Single Rod

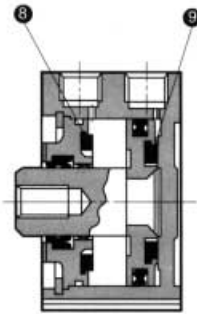

With Cushion

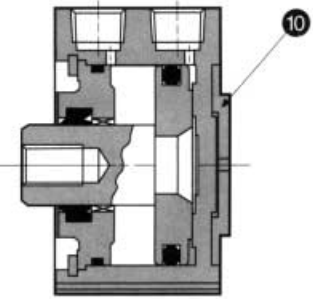

End Boss Head End

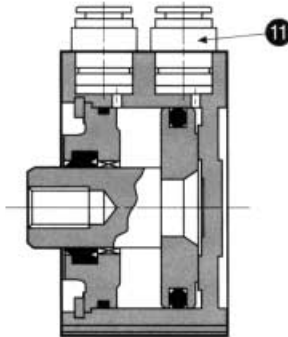

One Touch Fittings

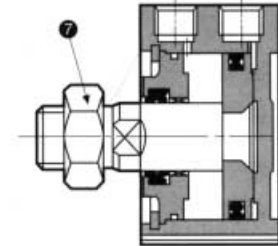

Male Thread With Jam Nut

Parts list

No.	Description	Material	Remarks
1	Cylinder tube	Aluminum alloy	Hard anodized
2	*Piston	Aluminum alloy	Chromate
3	*Piston rod	Stainless steel	ø12-25
		Carbon steel	ø32-100, hard chrome plated
4	Collar	Bearing grade aluminum	ø12-40, black anodized
		Aluminum alloy casting	ø50-100, black painted
5	Retaining ring	Carbon tool steel	Phosphate coating

No.	Description	Material	Remarks
6	Bushing	Leaded tin bronze casting	Used for only ø50 and above
7	Rod end nut	Carbon steel	Nickel plated
8	Bumper A	polyurethane rubber	
9	Bumper B	polyurethane rubber	
10	End boss	Aluminum alloy	Hard anodizing
11	One touch fittings	—	ø32-ø63

* Piston and piston rod are connected (one-piece).
For bore size 12-ø25 rubber cushion using stainless steel piston rod.

Seal List

No.	Description	Material	Parts No.										
			ø12	ø16	ø20	ø25	ø32	ø40	ø50	ø63	ø80	ø100	
12	Piston seal	NBR	NLP-12-7L	NLP-16A	NLP-20A	NLP-25A	NLP-32A	NLP-40A	NLP-50A	NLP-63B	NLP-80B	NLP-100B	
13	Rod seal	NBR	DYR-6K	DYR-8K	DYR-10SK	DYR-12	DYR-16	PDU-16Z	PDU-20Z	PDU-20Z	PDU-25Z	PDU-30Z	
14	Gasket	NBR	SP-013-6	C14	C18	C22	C29	C36	C46	C60	C75	C95	

Air Hydro (CQ2 only)

No.	Description	Material	Parts No.							
			ø20	ø25	ø32	ø40	ø50	ø63	ø80	ø100
12	Piston seal	NBR	RPS-20A	RPS-25A	RPS-32A	RPS-40A	RPS-50A	RPS-63A	RPS-80A	RPS-100A
13	Rod seal	NBR	PS-10	PS-12	PS-16	HDU-16	HDU-20	HDU-20	HDU-25	HDU-30
14	Gasket	NBR	C18	C22	C29	C36	C46	C60	C75	C95

Seal Kit Part Numbers

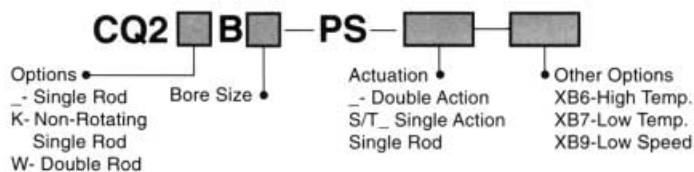

(N)CQ2 Series

Bore Size $\phi 12 \sim \phi 25$

Through Hole / (N)CQ2B

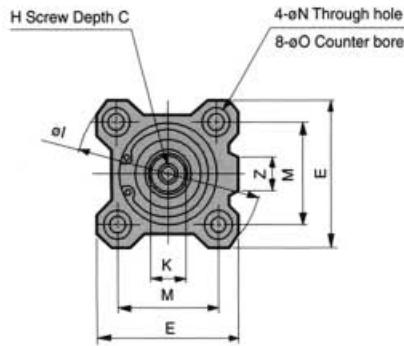

Both ends tapped

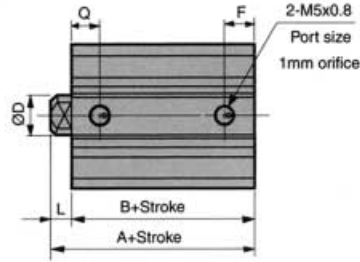
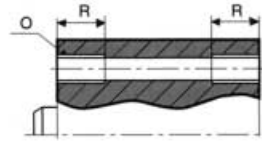

(N)CQ2A Both Ends Tapped

Bore size	CQ2 O	NCQ2 inch O	R
12	M4x0.7	8-32 UNC	7
16	M4x0.7	8-32 UNC	7
20	M6x1.0	1/4 - 20 UNC	10
25	M6x1.0	1/4 - 20 UNC	10

Standard

Bore size	Stroke	A	B	CQ2 C	NCQ2 C	D	E	F	CQ2 H	NCQ2 inch H	I	K	L	M	N	O	Q	Z
12	5~30	20.5	17	6	5.4	6	25	5	M3x0.5	#8-32	32	5	3.5	15.5	3.5	6.5 depth 3.5	7.5	-
16	5~30	22	18.5	8	5.4	8	29	5.5	M4x0.7	#8-32	38	6	3.5	20	3.5	6.5 depth 3.5	8	10
20	5~50	24	19.5	7	7	10	36	5.5	M5x0.8	#10-32	47	8	4.5	25.5	5.5	9 depth 7	9	10
25	5~50	27.5	22.5	12	10	12	40	5.5	M6x1.0	1/4 - 28 UNF	52	10	5	28	5.5	9 depth 7	11	10

Note) The external dimensions of cylinder with rubber cushion are the same as that of the above standard.

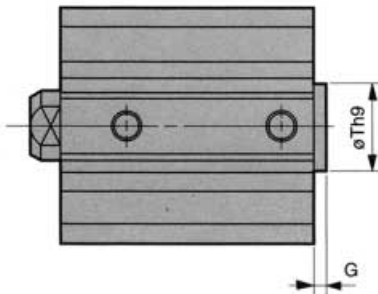

Piston Rod

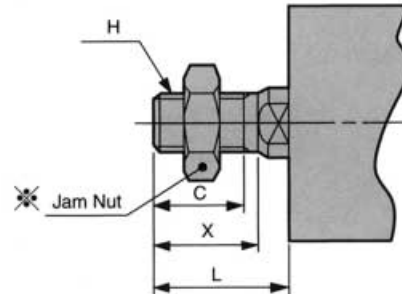

End Boss (CQ2 only) mm

Bore size	G	Th9
12	1.5	15 $^{0}_{-0.043}$
16	1.5	20 $^{0}_{-0.052}$
20	2	13 $^{0}_{-0.043}$
25	2	15 $^{0}_{-0.043}$

NCQ2 Male Rod End mm

Bore size	X	H inch	L	K
12	8	#8-32UNC	11.5	5
16	8	#8-32UNC	11.5	6
20	8	#10-32UNF	12.5	8
25	9.5	1/4-28UNF	14.5	10

CQ2 Male Rod End mm

Bore size	C	X	H	L	K
12	9	10.5	M5x0.8	14	5
16	10	12	M6x1.0	15.5	6
20	12	14	M8x1.25	18.5	8
25	15	17.5	M10x1.25	22.5	10

Note 1) Rod side End Boss is offered as an option.
(Add - XC36 at the end of part no.)

✳ Rod end nut and accessories detail: see p. 6.
"C" dim. not applicable.

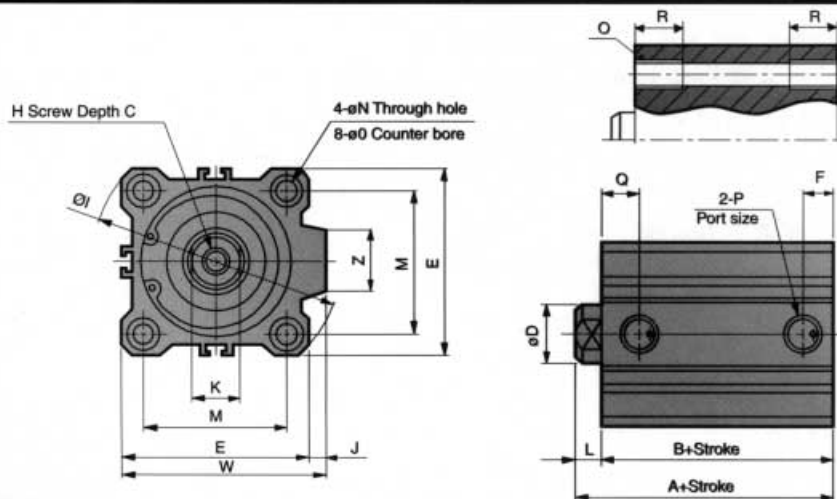
Bore Size $\phi 32 \sim \phi 100$ (N)CQ2A
Both Ends Tapped

Bore size	CQ2 O	NCQ2 inch O	R
32	M6x1.0	1/4 20 UNC	10
40	M6x1.0	1/4 - 20 UNC	10
50	M8x1.25	5/16 - 18 UNC	14
63	M10x1.5	7/16 - 14 UNC	18
80	M12x1.75	1/2 - 13 UNC	22
100	M12x1.75	1/2 - 13 UNC	22

Standard

Bore size	Stroke (mm)	A	B	CQ2 C	NCQ2 C	D	E	F	CQ2 H	NCQ2 Inch H	I	J	K	L	M	N	O	P	Orifice	Q	W	Z
32	5	30	23	13	13.3	16	45	5.5	M8x1.25	5/16-24UNF	60	4.5	14	7	34	5.5	9 depth 7	M5x0.8	1.7	11.5	49.5	14
	75, 100	40	33					7.5										10.5				
40	5~50	36.5	29.5	13	18.3	16	52	8	M8x1.25	3/8-24UNF	69	5	14	7	40	5.5	9 depth 7	1/8	2	11	57	14
	75, 100	46.5	39.5																			
50	10~50	38.5	30.5	15	17.6	20	64	10.5	M10x1.5	1/2-20UNF	86	7	17	8	50	6.6	11 depth 8	1/4	2.2	10.5	71	19
	75, 100	48.5	40.5																			
63	10~50	44	36	15	17.6	20	77	10.5	M10x1.5	1/2-20UNF	103	7	17	8	60	9	14 depth 10.5	1/4	3	15	84	19
	75, 100	54	46																			
80	10~50	53.5	43.5	21	24.3	25	98	12.5	M16x2.0	5/8-18UNF	132	6	22	10	77	11	17.5 depth 13.5	3/8	4	16	104	26
	75, 100	63.5	53.5																			
100	10~50	65	53	27	27	30	117	13	M20x2.5	3/4-16UNF	156	6.5	27	12	94	11	17.5 depth 13.5	3/8	5	23	123.5	26
	75, 100	75	63																			

- Note 1) The external dimensions of cylinder with rubber cushion are the same as that of the above standard.
2) In case of built-in fitting type, bore size $\phi 32$, 5 stroke has the same external dimensions as 10 stroke.

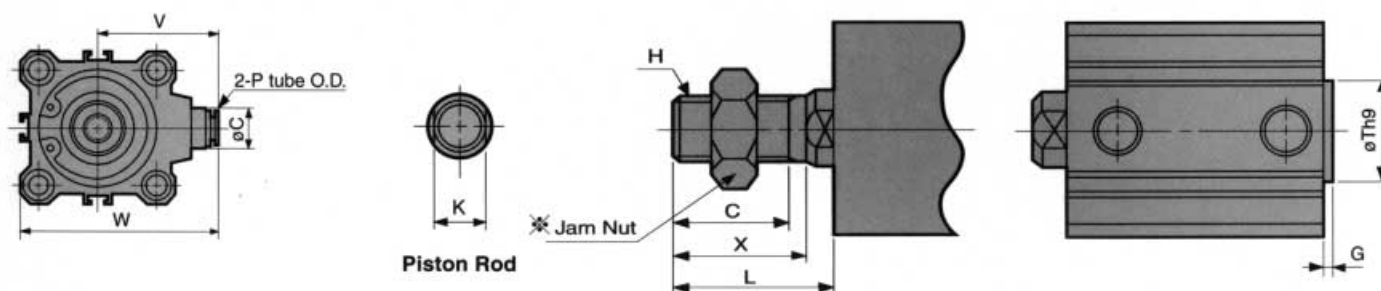

One Touch Fittings

Bore size	C	P	V	W
32	13	6	38	60.5
40	13	6	42	68
50	16	8	50	82
63	16	8	56.5	95

NCQ2 Male Rod End

Bore size	X	H Inch	L	K
32	12.7	5/16-24UNF	19.7	14
40	16	3/8-24UNF	23	14
50	19.5	1/2-20UNF	27.5	17
63	19.5	1/2-20UNF	27.5	17
80	25.5	5/8-18UNF	35.5	22
100	28.5	3/4-16UNF	40.5	27

CQ2 Male Rod End

Bore size	C	X	H	L	K
32	20.5	23.5	M14x1.5	28.5	14
40	20.5	23.5	M14x1.5	28.5	14
50	26	28.5	M18x1.5	33.5	17
63	26	28.5	M18x1.5	33.5	17
80	32.5	35.5	M22x1.5	43.5	22
100	32.5	35.5	M26x1.5	43.5	27

End Boss (CQ2 only)

Bore size	G	Th9
32	2	21 ⁰ _{-0.052}
40	2	28 ⁰ _{-0.052}
50	2	35 ⁰ _{-0.062}
63	2	35 ⁰ _{-0.062}
80	2	43 ⁰ _{-0.062}
100	2	59 ⁰ _{-0.074}

- "C" dimension not applicable
*Rod end nut and accessories are detailed on p. 6.

- Note) With rod end inlets an option.
(Add - XC36 at the end of part no.)



Compact Cylinder
With Autoswitch

(N)CDQ2 Series

Standard Specifications

Model	Air pressure type (Non-lube type)	Air-hydro type
Media	Air	Hydraulic oil
Ambient and fluid temp.	15~140°F(-10°C~+60°C)(At freezing temp. air must be dry)	

The rest of the specifications are the same as that of standard (See p. 3).

Auto Switch Mounting Available / Minimum Stroke

# of Auto Switch Mounting	D-F7□V D-J79C	D-A7 D-A8 D-A73C D-A80C	D-F7□WV	D-A7□H D-A80H D-F7□ D-J79	D-A79W	D-F7□W D-J79W D-F7BAL D-F79F	D-F7LF
1pcs	5mm	5mm	10mm	15mm	15mm	20mm	25mm
2pcs	5mm	10mm	15mm	15mm	20mm	20mm	25mm



Auto Switch Mounting / Parts No.

Bore size (mm)	Part No.	Note	Applicable auto switch
12•16•20•25	BQ-1	•Auto switch mounting screw (M3x0.5x8L) •Square nut	D-A7 • A8 D-A7OH • A80H D-AOC • A80C D-F79 D-F79W J-J79C
32•40•50• 63•89•100• 125•140•160	BQ-2	•Auto switch mounting screw (m3x0.5x8L) •Auto switch spacer •Auto switch mounting nut	

How To Order

Auto Switch How To Order: See p. 2

Auto Switch Specification

Reed switch type

Auto switch model	D-A72 A72H	D-A73,A73H		D-A76H	D-A80,A80H			D-A73C	D-A80C	Two color indicator lamp D-A79W
Application	Relay, PLC			IC circuit	Relay, PLC, IC circuit			Relay, PLC	Relay, PLC, IC circuit	Relay, PLC
Load voltage	200VAC	100VAC	24VDC	4~8VDC	24VAC/ VDC or less	48VAC/ VDC	100VAC/ VDC	24VDC	24VAC/ VDC	24VDC
Max. load current or load current range	5~10mA	5~20mA	5~40mA	Max. 20mA	Max. 50mA	Max. 40mA	Max. 20mA	5~40mA	Max. 50mA	5~40mA
Internal voltage drop	2.4V or less			0.8V or less	0			2.4V or less	0	4V or less
Leak current	0									
Response time	1.2ms									
Indicator lamp	ON: Red light emitting diode			None			ON: Red light emitting diode	None	Response position: Red light emitting diode Best response position: Green light emitting diode	
Lead wire entry	Grommet (D-A7 0 H, 80H: Horizontal cable access)							Connector	Grommet	
Lead wire	Note) Oil proof vinyl ø 3.4, 0.2mm ² ,0.5m									
Impact resistance	30G									
Insulation resistance	50MΩ or more under the test voltage 500 VDC (Between case and cable)									
Withstand voltage	1500 VAC 1 min (Between case and cable)									
Ambient temperature	-10°~60°C									
Protection structure	IEC spec IP67, JISC0920 (Water proof). Oil proof									

Note) • D-A76H: 3 wires {Brown (red), Black (white), Blue (black)},
Others: 2 wires {Brown (red), Black (white)} - Lead wire length: 0.5m(Standard), 3m(Option)

Solid State Switch Type

Auto switch model	PNP 3 wire type D-F7P	2 wire type D-F7BV	2 wire type D-J79(C)	PNP 3 wire type two color indicator lamp D-F79W	2 wire type two color indicator lamp D-F7BWV
Application	Relay, PLC	Relay, PLC		Relay, PLC, IC circuit	Relay, PLC
Power source	5, 12, 24VDC (4.5~28VDC)	-		4.5~28VDC	-
Current consumption	OFF:1mA or less ON:15mA or less	-		OFF:1mA or less ON:12mA or less	-
Load voltage	—	24VDC (10~28VDC)		28VDC or less	24VDC (10~28VDC)
Max. load current or load current range	Max. 80mA	5~40mA		Max. 40mA	5~40mA
Internal voltage drop	0.8V or less	4V or less		1.5V or less (0.8V or less at 10mA of load current)	4V or less
Leak current	24VDC: 100 μA or less	24VDC: 0.8mA or less		100μA or less at 24VDC	24VDC: 0.8mA or less

Auto switch model	NPN 3 wire type D-F7NV	NPN 4 wire type two color indicator lamp D-F79F	NPN 4 wire type two color indicator lamp D-F7LF	NPN 3 wire type two color indicator lamp D-F79W	2 wire type two color indicator lamp D-J79W
Application	Relay, PLC, IC circuit	Relay, PLC, IC circuit		Relay, PLC, IC circuit	Relay, PLC
Power source	5, 12, 24VDC (4.5~28VDC)	4.5~28VDC	24VDC (20~26VDC)	12V, 24VDC	-
Current consumption	OFF:1mA or less ON:12mA or less	OFF:1mA or less ON:10mA or less	20mA or less	10mA	-
Load voltage	28VDC or less	28VDC or less	26VDC or less	28VDC or less	24VDC (10~28VDC)
Max. load current or load current range	Max. 40mA	Max. 40mA		Max. 40mA	5~40mA
Internal voltage drop	1.5V or less (0.8V or less at 10mA of load current)	1.5V or less (0.8V or less at 10mA of load current)	0.8V or less	1.5V or less (0.8V or less at 10mA of load current)	4V or less
Leak current	100μA or less at 24VDC	100μA or less at 24VDC		100μA or less at 24VDC	0.8mA or less at 24VDC

Auto switch model	NPN 3 wire type D-F79	PNP 3 wire type D-F7PV	NPN 3 wire type D-F7NTL	2 wire type D-F7BAL	NPN 3 wire type two color indicator lamp D-F7NWW
Application	Relay, PLC, IC circuit	Relay, PLC, IC circuit	Relay, PLC, IC circuit	Relay, PLC	Relay, PLC
Power source	5, 12, 24VDC (4.5~28VDC)	4.5~28VDC	4.5~28VDC	-	12~24VDC
Current consumption	OFF:1mA or less ON:12mA or less	15mA or less	OFF:1mA or less ON:10mA or less	-	10mA or less
Load voltage	28VDC or less	-	28VDC or less	24VDC (10~28VDC)	28VDC or less
Max. load current or load current range	Max. 40mA	Max. 80mA	Max. 80mA	5~40mA	Max. 40mA
Internal voltage drop	1.5V or less (0.8V or less at 10mA of load current)	0.8V or less	2V or less (0.8V or less at 10mA)	4V or less	1.5V or less (0.8V or less at 10mA of load current)
Leak current	100μA or less at 24VDC	100μA or less at 24VDC	100μA or less at 24VDC	0.8mA at 24VDC	100μA or less at 24VDC
Response time	1ms or less				
Indicator lamp	ON: Red light emitting diode			Response position:Red light emitting diode Best response position: Green light emitting diode	
Lead wire entry	Grommet ("C" Connector)				
Lead wire	Note: Oil proof vinyl ø 3.4, 0.2mm ² ,05.m length (L, 3m option)				
Impact resistance	100G				
Insulation resistance	50MΩ or more under the test voltage 500VDC (Between case and cable)				
Withstand voltage	1000 VAC 1 min (Between case and cable)				
Ambient temperature	-10°~60°C				
Protection structure	IEC spec IP67, JIS C0920 (Water proof). Oil proof				

Weight Chart

lbs

Bore size (mm)	Cylinder Stroke											
	5	10	15	20	25	30	35	40	45	50	75	100
12	0.110	0.126	0.141	0.157	0.172	0.187	-	-	-	-	-	-
16	0.157	0.181	0.207	0.232	0.256	0.280	-	-	-	-	-	-
20	0.229	0.271	0.315	0.359	0.406	0.450	0.494	0.540	0.584	0.631	-	-
25	0.284	0.331	0.395	0.423	0.472	0.518	0.564	0.613	0.657	0.706	-	-
32	0.571	0.598	0.624	0.650	0.701	0.750	0.800	0.851	0.902	0.961	1.22	1.47
40	0.752	0.805	0.858	0.908	0.953	0.997	1.05	1.09	1.14	1.20	1.44	1.68
50	-	1.10	1.17	1.25	1.34	1.43	1.50	1.58	1.66	1.78	2.18	2.50
63	-	1.60	1.69	1.78	1.87	1.97	2.06	2.15	2.23	2.38	2.84	3.29
80	-	3.53	3.74	3.95	4.16	4.36	4.57	4.78	4.99	5.28	6.31	7.33
100	-	5.55	5.68	5.81	6.05	6.29	6.52	6.75	6.97	7.31	8.45	9.59

Weight Adder

lbs

Bore Size	ø12	ø16	ø20	ø25	ø32
Both ends tapped	0.002	0.002	0.007	0.007	0.013
Rod end					
Thread	0.003	0.007	0.013	0.026	0.057
Nut	0.002	0.004	0.009	0.018	0.037
Boss mtg	0.002	0.003	0.004	0.007	0.011
W/ Cushion	0.000	-0.002	-0.004	-0.007	-0.007
W/ One touch	-	-	-	-	0.026
Foot	0.108	0.137	0.324	0.373	0.315
Rod flange	0.119	0.148	0.289	0.337	0.397
Head flange	0.115	0.139	0.273	0.318	0.364
Double clevis	0.064	0.077	0.172	0.251	0.333
Bore Size	ø40	ø50	ø63	ø80	ø100
Both ends tapped	0.013	0.013	0.042	0.099	0.099
Rod end					
Thread	0.060	0.117	0.117	0.265	0.386
Nut	0.037	0.071	0.071	0.108	0.256
Boss mtg	0.015	0.029	0.055	0.099	0.212
W/ Cushion	-0.015	-0.020	-0.040	-0.068	-0.123
W/ One touch	0.026	0.046	0.046	-	-
Foot	0.342	0.536	0.714	1.535	2.342
Rod flange	0.472	0.822	1.233	2.328	3.010
Head flange	0.437	0.767	1.177	2.242	2.886
Double clevis	0.432	0.867	1.222	2.445	4.161

How to calculate weight (lbs)

When mounting auto switch, add for additional mounting bracket weight

(N)CDQ2D32-20DCM
 Std Wt.: (N)CDQ2B32-20D .65
 Wt. adder: Both ends tapped .013
 Jam nut .037
 W/ rubber cushion -.007
 Clevis mounting .333
 Total 1.026

Autoswitch Mounting Bracket Weight

Part no.	Applicable cylinder bore size	Weight lbs.
BQ-1	12- 25	.003
BQ-2	32- 100	.003

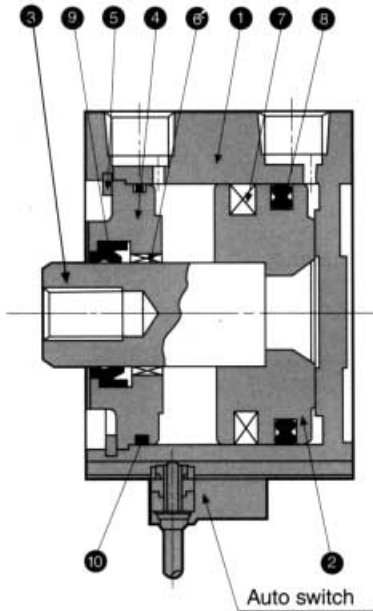

Parts List

No.	Description	Material	Remarks
1	Cylinder tube	Aluminum alloy	Hard anodized
2	Piston	Aluminum alloy	Chromate
3	Piston rod	Stainless steel	Bore ø12-ø25
		Carbon steel	Bore ø32-ø100, hard chrome plated
4	Collar	Aluminum alloy	Bore ø12-ø40, Black anodized
		Aluminum alloy casting	Bore ø50-ø100, Black paint
5	Retaining ring	Carbon tool steel	Phosphate coating
6	Bushing	Leaded tin bronze casting	Bore ø50-ø100
7	Magnet	----	

Seals List

No.	Description	Material	Parts No.									
			ø12	ø16	ø20	ø25	ø32	ø40	ø50	ø63	ø80	ø100
8	Piston seal	NBR	NLP-12-7L	NLP-16A	NLP-20A	NLP-25A	NLP-32A	NLP-40A	NLP-50A	NLP-63B	NLP-80B	NLP-100B
9	Rod seal	NBR	DYR-6K	DYR-8K	DYR-10SK	DYR-12	DYR-16	PDU-16Z	PDU-20Z	PDU-20Z	PDU-25Z	PDU-30Z
10	Gasket	NBR	SO-013-6	C14	C18	C22	C29	C36	C46	C60	C75	C95

Air Hydro

No.	Description	Material	Parts No.							
			ø20	ø25	ø32	ø40	ø50	ø63	ø80	ø100
8	Piston seal	NBR	RPS-20A	RPS-25A	RPS-32A	RPS-40A	RPS-50A	RPS-63A	RPS-80A	RPS-100A
9	Rod seal	NBR	PS-10	PS-12	PS-16	HDU-16	HDU-20	HDU-20	HDU-25	HDU-30
10	Gasket	NBR	C18	C22	C29	C36	C46	C60	C75	C95