

Cooper Bussmann

[Homepage](#)
[About Cooper Bussmann](#)
[Contact Us](#)
[Privacy](#)
[Legal](#)
[Cooper Bussmann® Brand](#)
[Site Map](#)



GMT-3/4A

Product Information

Product Family:	Telecommunications
-----------------	--------------------

Fast-Acting Indicating Telecom Fuse

60Vdc/125Vac



Dimensional Data — in

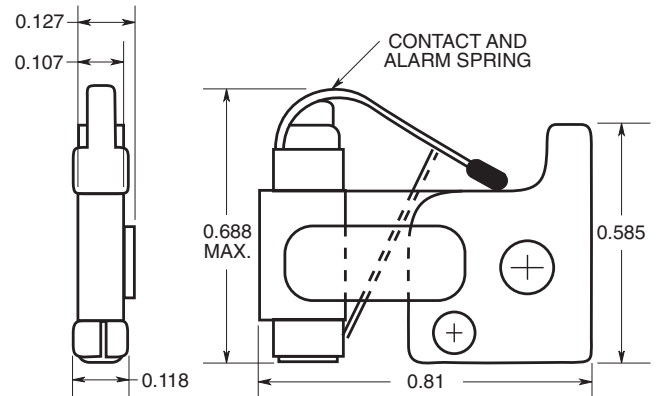

Catalog Symbol: GMT

Fast-acting indicating fuse for telecom circuits.

Ratings:

Volts: 60Vdc/125Vac

Amps: 18/100 – 15A

IR: 450A @ 60Vdc

300A @ 125Vac

Agency Information:

UL Recognized, Guide JFHR2, File E56412

Materials:

Body: Thermoplastic (flammability rating: UL94V0)

Terminals: Tin-plated beryllium copper

Carton Quantity & Weight:

100 fuses per carton, 0.33 lbs. (150g.)

Fuse Holders: Catalog Nos. HLS, HLT and PCT

General Information:

- For telecom, computer, or control circuits.
- Visual spring indicating and alarm circuit indicating.
- Color coded flags designate amp rating.
- Fuses easily replaced without use of insulated tools.
- Fuses can be removed with wire hook when mounted on minimum centers.
- **GMT-X** fuse cover available.
- **GMT-Y** fuse cover (with pull-tab) available.

Covers — in (mm)

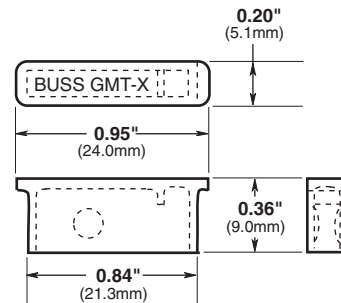

GMT-X Fuse Cover

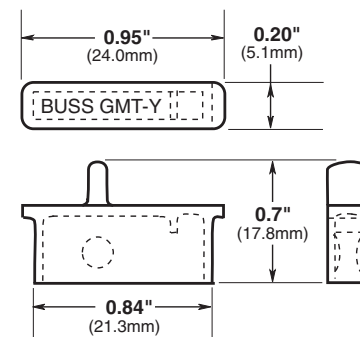

GMT-Y Fuse Cover

Catalog Symbol and Color Codes

Catalog Symbol	Color Code	Catalog Symbol	Color Code
GMT-18/100A	Yellow	GMT-3 1/2A	White/Blue
GMT-1/4A	Violet	GMT-4A	White/Brown
GMT-3/8A	White/Gray	GMT-5A	Green
GMT-1/2A	Red	GMT-7 1/2A	Black/White
GMT-65/100A	Black	GMT-10A	Red/White
GMT-3/4A	Brown	GMT-12A	Yellow/Green
GMT-1A	Gray	GMT-15A	Red/Blue
GMT-1 1/3A	White	GMT-Dummy	Gray
GMT-1 1/2A	White/Yellow	GMT-A (alarm)*	Yellow
GMT-2A	Orange	GMT-X (cover)	Clear
GMT-3A	Blue		

*Designed specifically for use in the Telpower® Series 15800 fused disconnect switch.