



PC-TFT-64PA

Interface Board

Features

- Used for TFT-LCD display: 6.4" AND-TFT-64PA
- Ultra Compact
- NTSC/PAL video auto switch
- Requires only +12VD input
- DC/DC/DC/AC video decoder all-in-one
- Up/Down & Left/Right display reverse
- **RoHS Compliant**

The PC-TFT-64PA is designed to work with the AND-TFT-64PA color TFT display which is suitable for security, video game, door phone, video phone, portable TV and instrument display applications.

Mechanical Characteristics

Item	Specification	Unit
Screen Size	6.4 (diagonal)	inch
Display Format	960 x 234	dot
Active Area	129.6 (H) x 97.34 (V)	mm
Dot Pitch	0.135 (W) x 0.416 (H)	mm
Pixel Configuration	Stripe	–
Outline Dimension	127.4 (W) x 92.8 (H) x 12.9 (D)	mm
Weight	235 ± 10	g
Contrast Ratio	150:1	–
View Angle	(V) +40° / -55°	deg
	(H) ± 60°	
Color	Full Color	–
Brightness	330	cd/m ²

Absolute Maximum Rating

Item	Symbol	Conditions	Min.	Max.	Unit
Operating Temperature	Top	–	0	60	°C
Storage Temperature	Tstg	–	-30	80	°C

Product specifications contained herein may be changed without prior notice.
It is therefore advisable to contact Purdy Electronics before proceeding with the design of equipment incorporating this product.

Electronic Characteristics

Pin No.	Symbol	Conditions	Input/Output	Min.	Typ.	Max.	Unit
5	Video	NTSC/PAL @ (75Ω)	Input	–	1	–	p-p
1	Vin	DC (+)	Input	10	12	14	V
	Iin			–	560	–	mA
	Pin	DC (+12V)		–	6.72	–	W
6	Vo	DC (+)	Output	–	5	–	V
	Io			–	2	–	mA
7	Bright	DC (+)	Input	1.83	2.00	2.15	V
8	Contrast I	DC (+)	Input	2.30	2.70	2.90	V
9	Color	DC (+)	Input	2.65	3.35	3.80	V
10	Tint	DC (+) NTSC only	Input	1.00	2.98	4.00	V
11	NTSC/PAL	(Option)	Output	–	TTL	–	
12	Left/Right		Input	–	TTL	–	
13	Up/Down		Input	–	TTL	–	
14	DIM	DC (+)	Input	0	–	4	V
–	–	Operating Temperature	–	0	–	60	°C

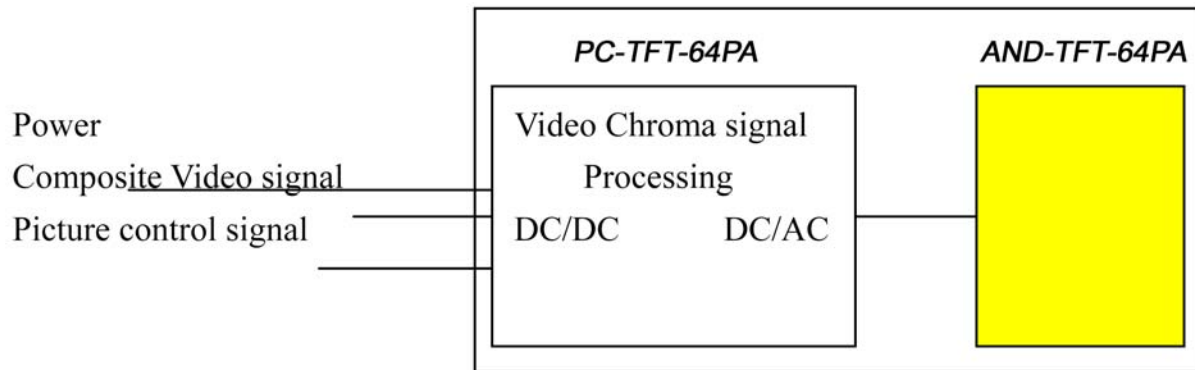
Block Diagram

Dimensional Outline

Board

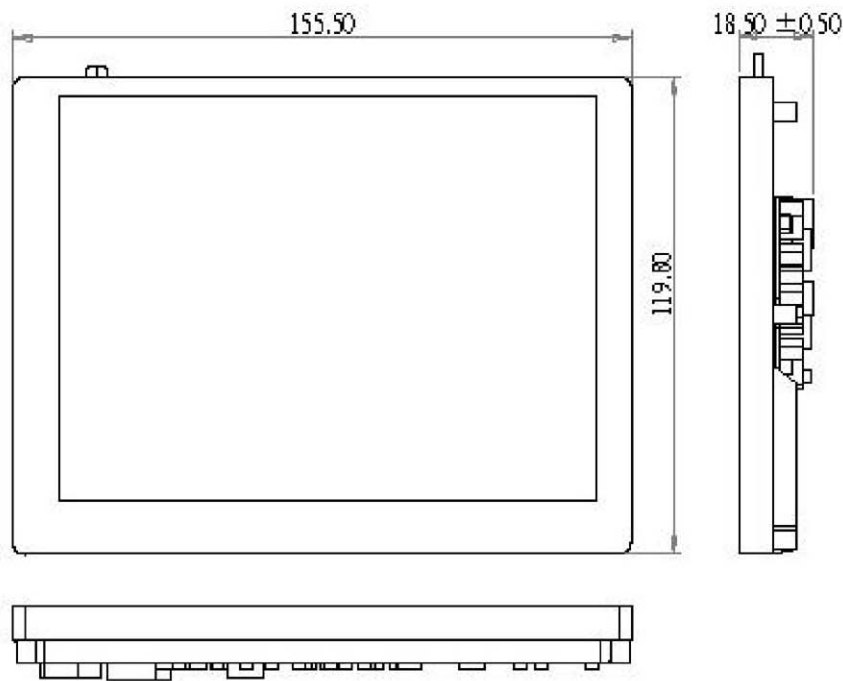
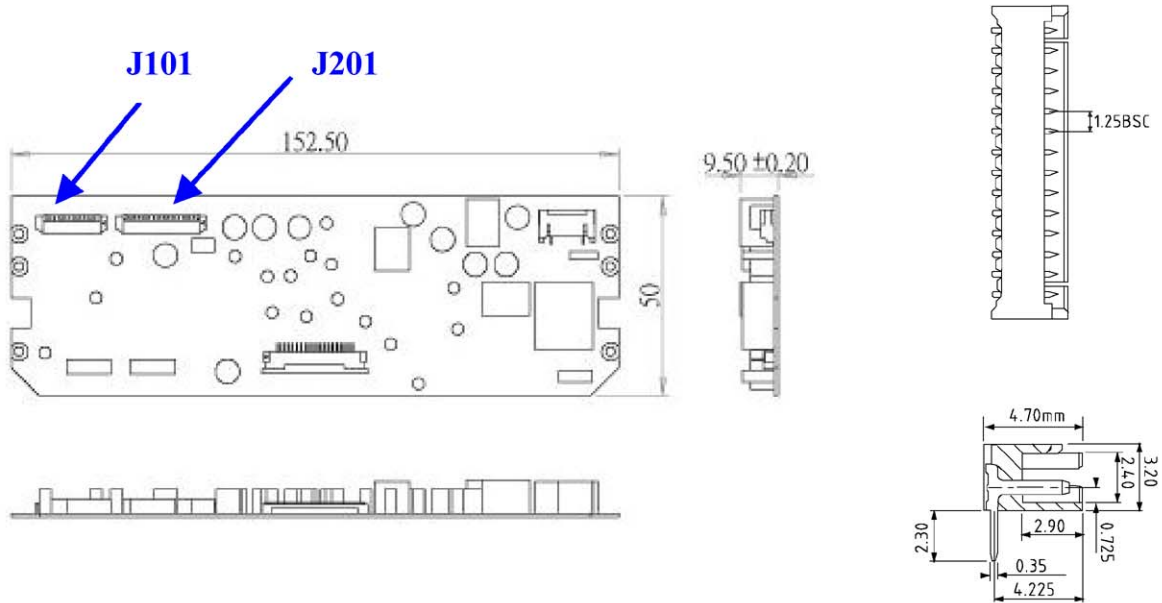

Pin Assignment

Pin	Symbol
1	Vin
2	GND (Power)
3	GND (Power)
4	GND (Power)
5	Video in
6	+5V
7	Bright
8	Contrast
9	Color
10	Tint (NTSC only)
11	NTSC/PAL
12	Left/Right
13	Up/Down
14	DIM

Pin Assignment (Option)

Pin	Symbol
1	EXT.R
2	EXT.G
3	EXT.B
4	EXT.switch
5	Composite sync. input
6	Video Composite sync output
7	Horizontal sync output
8	Vertical sync output
9	Ground
10	Chroma signal input

Note: If you use EXT.R.G.B or Y/C video input mode, please contact Purdy to modify some components of the interface board.

DIM CURVE

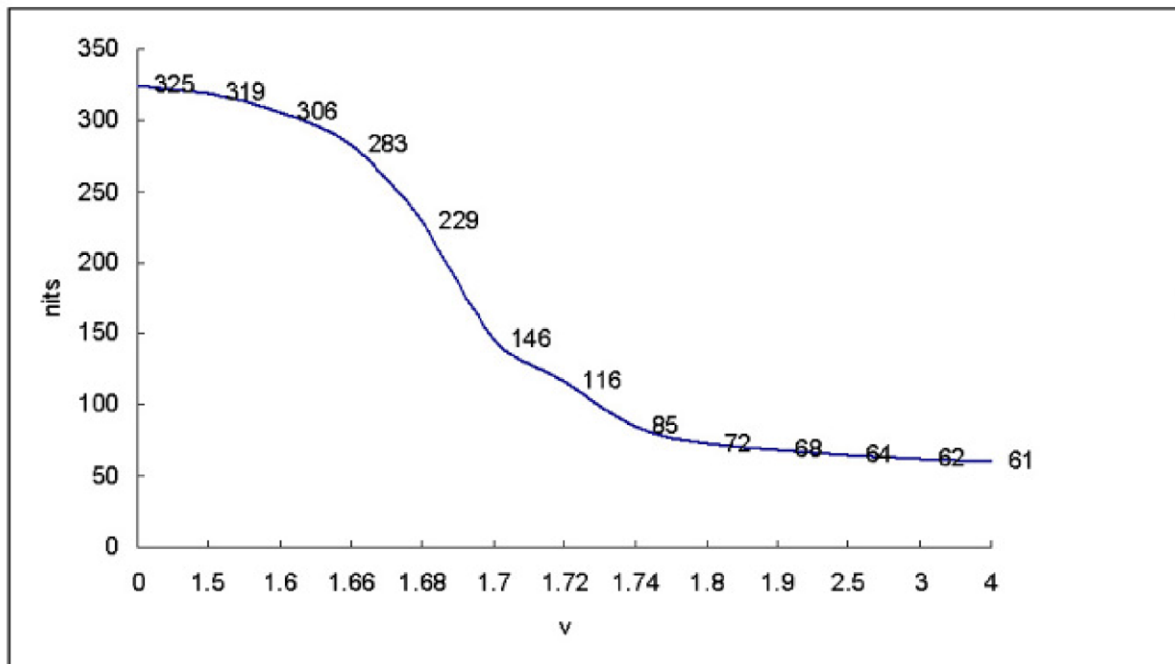

Board

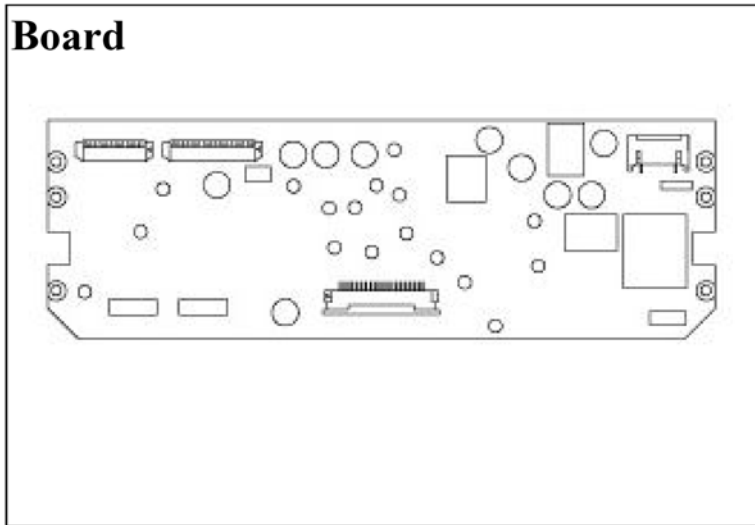

Module

