

### LITHIUM - Vanadium Pentoxide Rechargeable

Panasonic Vanadium Pentoxide (VL Type) rechargeable lithium batteries are compact, high energy secondary batteries that have nearly twice the energy of conventional button-shaped Ni-Cd batteries.



#### Features:

- One high-voltage battery can serve your backup needs
- Can provide the voltage equivalent of two or three 1.2V Ni-Cd's or two capacitors
- Months of continuous use as a backup
- Self discharge rate less than 2% a year
- Superior reliability; withstands overcharging and discharging

#### Applications:

- ECRs
- Memory back-up in facsimiles
- Memory cards
- Personal computers
- Sequencers
- Telephones
- Tuners
- Video cameras
- VTRs

**Technical Data - Table 1 - Lithium Vanadium Pentoxide Rechargeable (VL)**

Model No.	Nominal Voltage (V)	Nominal Capacity (mAh)	Dimensions (mm)		Basic Battery Weight (g)	Continuous Drain (mA)	Tab Configurations
			External Diameter	Height			
<a href="#">VL621</a>	3.0	1.5	6.8	2.1	0.3	0.01	
<a href="#">VL1220</a>	3.0	7.0	12.5	2.0	0.8	0.03	
<a href="#">VL2020</a>	3.0	20.0	20.0	2.0	2.2	0.07	
<a href="#">VL2320</a>	3.0	30.0	23.0	2.0	2.8	0.10	
<a href="#">VL2330</a>	3.0	50.0	23.0	3.0	3.7	0.10	
<a href="#">VL3032</a>	3.0	100.0	30.0	3.2	6.3	0.20	

**Technical Data - Table 2 - Tab Configurations and Distributor Inventory**

Model No.	Tab Description Drawing	
<a href="#">VL621/F9D</a>	2 Pin, flat mount (w/o insulation wrap)	
<a href="#">VL1220/1HF</a>	2 Pin, horizontal mount, through holes, (with insulation wrap)	
<a href="#">VL1220/1VC</a>	2 Pin, vertical mount, through hole, (with insulation wrap)	
<a href="#">VL2020/1VC</a>	2 Pin, vertical mount, through hole, (with insulation wrap)	
<a href="#">VL2020/1HF</a>	2 Pin, horizontal mount, through hole, (with insulation wrap)	
<a href="#">VL2320/1VC</a>	2 Pin, vertical mount, through hole, (with insulation wrap)	
<a href="#">VL2320/1HF</a>	2 Pin, horizontal mount, through hole, (w/o insulation wrap)	
<a href="#">VL2320/1F2</a>	2 Pin, flat mount (w/o insulation wrap)	
<a href="#">VL2330/1VC</a>	2 Pin, vertical mount, through hole, (with insulation wrap)	
<a href="#">VL2330/1HF</a>	2 Pin, horizontal mount, through hole, (with insulation wrap)	
<a href="#">VL2330/1F3</a>	2 Pin, flat mount, (with insulation wrap)	
<a href="#">VL3032/1GUF</a>	3 Pin, horizontal mount, through hole, (w/o insulation wrap)	
<a href="#">VL3032/1F2</a>	2 Pin, flat mount, through hole, (with insulation wrap)	

# Vanadium Pentoxide Lithium Coin Batteries (VL Series): Individual Specifications

## VL621

### ■ Dimensions(mm)

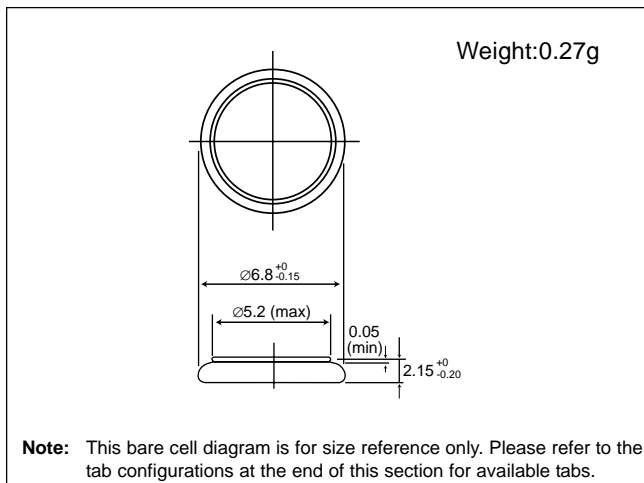

### ■ Specification

Nominal voltage (V)	3
Nominal capacity (mAh)	1.5
Continuous standard load (mA)	0.01
Operating temperature (C)	-20 ~ +60

### ■ Discharge Temperature Characteristics

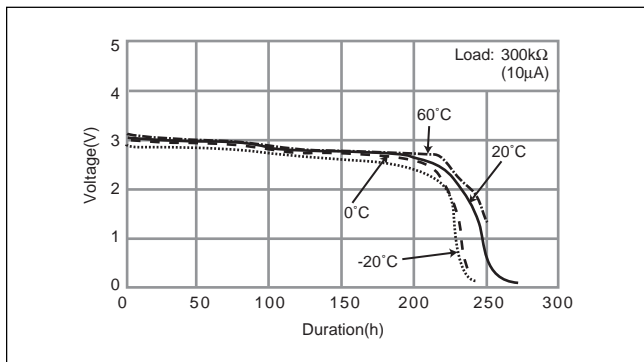

### ■ Consumption current vs. Duration time

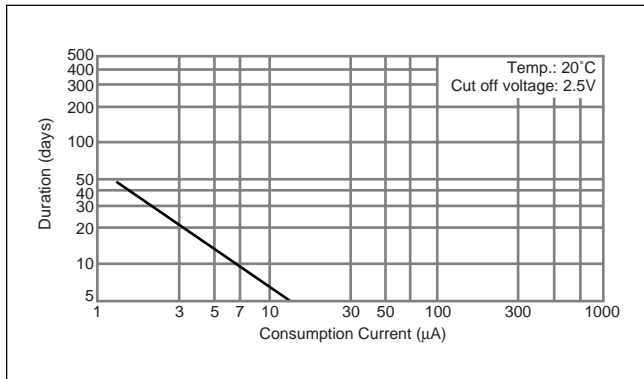

## VL1220

### ■ Dimensions(mm)

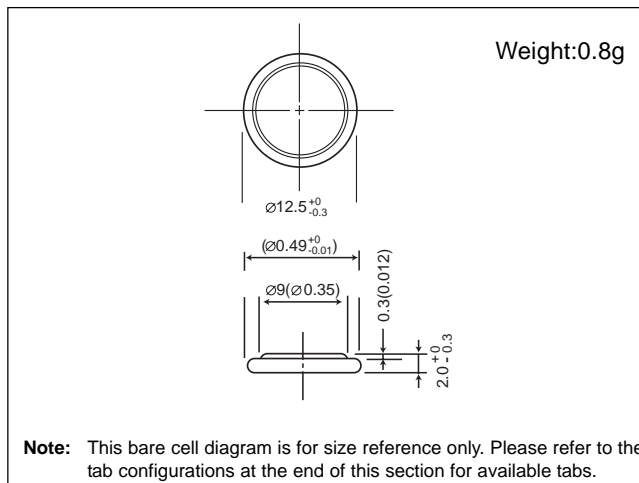

### ■ Specification

Nominal voltage (V)	3
Nominal capacity (mAh)	7.0
Continuous standard load (mA)	0.02
Operating temperature (C)	-20 ~ +60

### ■ Discharge Temperature Characteristics

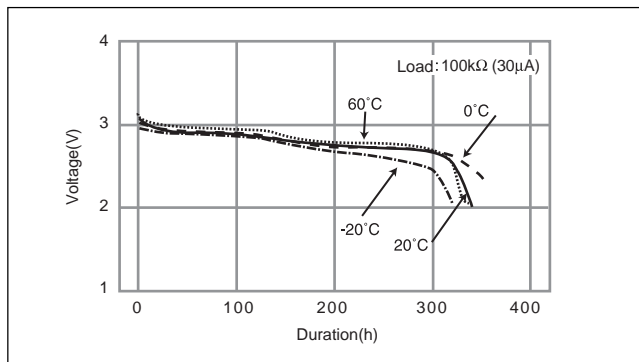

### ■ Consumption current vs. Duration time

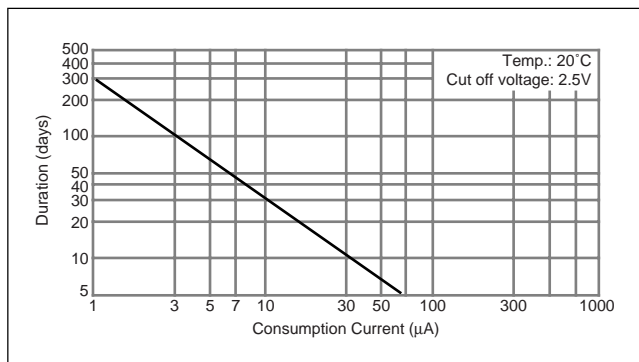

# Rechargeable Lithium Coin Batteries

## Vanadium Pentoxide Lithium Rechargeable Batteries (VL series)



### Features

These coin-type lithium batteries feature vanadium oxide for the positive pole, lithium alloy for the negative pole and a non-aqueous solvent for the electrolyte.

### Construction

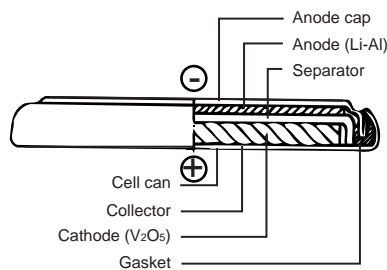

### Applications

- Memory backup power supplies for office automation equipment (personal computers, fax machines, etc.), audio-video equipment (VTRs, etc.), communications equipment (mobile phones, etc.), etc.
- Hybrid systems with solar batteries (solar remote controllers, etc.)



### General Specifications

Model	Electrical Characteristics (20°C)			Dimensions (mm)		Weight (g)	JIS	IEC
	Nominal Voltage (V)	*Nominal Capacity (mAh)	Continuous Drain (mA)	Diameter	Height			
VL621	3	1.5	0.01	6.8	2.1	0.27	-	-
VL1220	3	7.0	0.02	12.5	2.0	0.8	-	-
VL2020	3	20.0	0.07	20.0	2.0	2.2	-	-
VL2320	3	30.0	0.10	23.0	2.0	2.7	-	-
VL2330	3	50.0	0.10	23.0	3.0	3.5	-	-
VL3032	3	100.0	0.20	30.0	3.2	6.2	-	-

\* Nominal capacity shown above is based on standard drain and cut off voltage down to 2.5V at 20°C.

# Vanadium Pentoxide Lithium Rechargeable Batteries (VL Series):

## TAB CONFIGURATIONS

Model No.	Tab Type		Configuration Diagram No.	Nominal	
	With Insulation Wrap	Without Insulation Wrap		Voltage (V)	Capacity (mAh)
VL621		/F9D	1	3	1.5
VL1220	/1HF		2	3	7
	/1VC		3	3	7
	/1FC		4	3	7
	/1FC2		5	3	7
		/1F5U	6	3	7
VL2020	/1VC		7	3	20
	/1GU7		8	3	20
	/1HF		9	3	20
VL2320	/1VC		10	3	30
	/1HF		11	3	30
	/1F2		12	3	30
VL2330	/1VC		13	3	50
	/1HF		14	3	50
	/1F3		15	3	50
VL3032		/1GUF	16	3	100
	/1F2		17	3	100

**Notes:**

- A) To ensure proper electrical contact, it is recommended that rechargeable coin cell batteries be used with tabs for PC Board mounting.
- B) Please contact Panasonic for requests on custom tab configurations. Minimum order requirements may apply.

# VL Series Tab Configurations

## DIMENSIONS / MM (INCH)

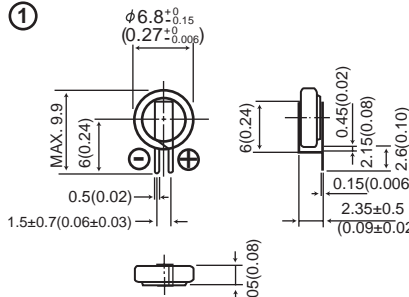
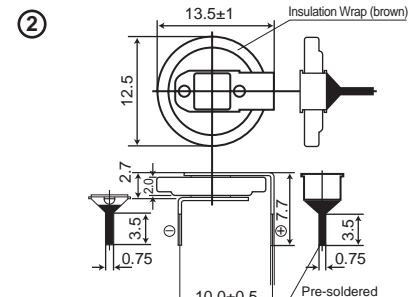
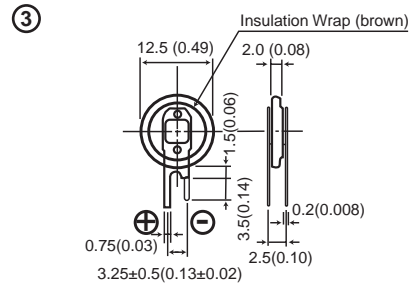
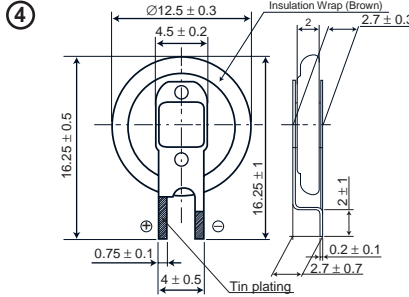
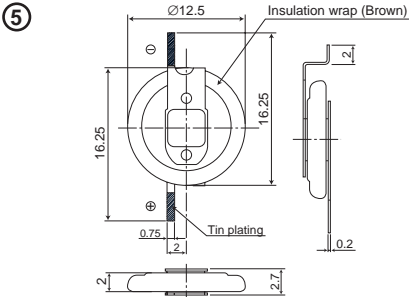
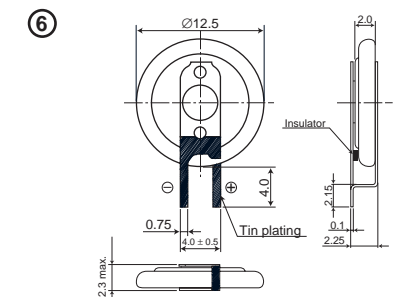
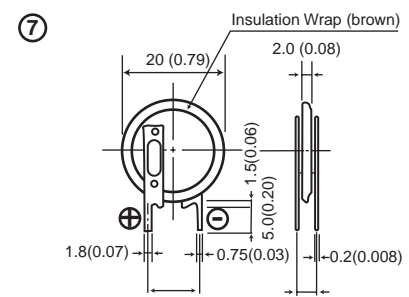
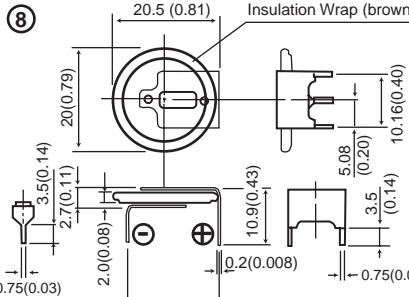
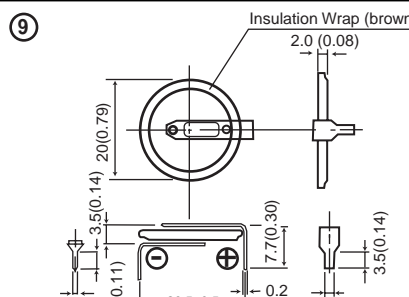
Model No.	Dimensions/mm (inch)	Model No.	Dimensions/mm (inch)
VL621/F9D (1.5mAh)		VL1220/1HF (7mAh)	
VL1220/1VC (7mAh)		VL1220/1FC (7mAh)	
VL1220/1FC2 (7mAh)		VL1220/1F5U	
VL2020/1VC (20mAh)		VL2020/1GU7 (20mAh)	
VL2020/1HF (20mAh)		VL2320/1VC (30mAh)	