

REV	DATE	DESCRIPTION	APP

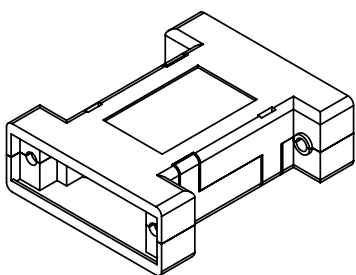
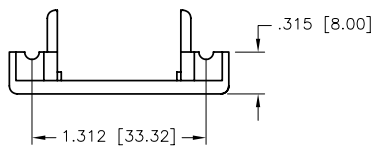
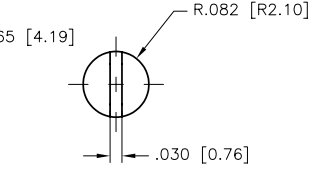
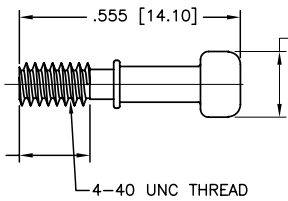
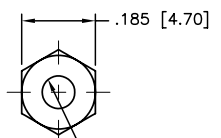
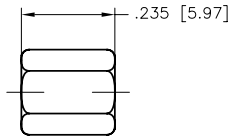
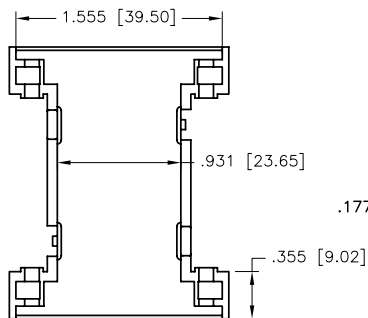
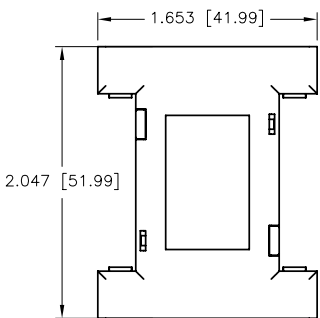
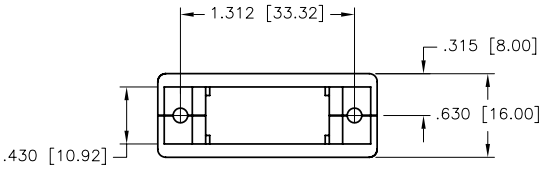

- NOTES:
1. MATERIAL: A.B.S. (UL94HB)
  2. COLOR: SEE NOTE 5
  3. DIMENSIONS: INCHES [MM]
  4. KIT INCLUDES:
    - 1 - 2 PC. COVER
    - 4 - #4-40 CAPTIVE SCREW
    - 4 - #4-40 HEX EXTENDER
  5. PART NO. 201E15F15F001 - BLACK  
PART NO. 201E15F15F003 - GRAY
  6. COMPLIANCE NOTE:  
PART MUST BE IN COMPLIANCE TO:  
DIRECTIVE 2002/95/EC of 27 January 2003 [RoHS]

THIS IS A CONTROLLED DOCUMENT AND IS SUBJECT TO CHANGE. CONTACT NORTHERN TECHNOLOGIES ENGINEERING FOR THE LATEST REVISION.

UNLESS OTHERWISE SPECIFIED  1. ALL DIMENSIONS ARE IN INCHES (MM) 2. DIMENSIONS ARE TYPICAL	SIGNATURES		DATE		Northern Technologies		THIS DRAWING IS THE PROPERTY OF NORTHERN TECHNOLOGIES AND SHOULD NOT BE REPRODUCED WITHOUT NORTHERN TECHNOLOGIES WRITTEN PERMISSION.	
	DRAWN	JSD	03-JAN-06		PART NUMBER 201E15F15F00X		DESCRIPTION 15M/F 15M/F GENDER CHANGER COVER [RoHS]	
	CHECKED	SCN	03-JAN-06		SHEET 1		CODE 7100_206	
	ISSUED		03-JAN-06		DWG NO. 7100-500-206		SCALE N.T.S.	
						SHEET 1 OF 1		