



D10 Expert™ – with Discrete Output and Bargraph Display†

Advanced sensor for use with plastic fiber optics



Standard Model



Stack of Models with Bussable Power Feature

Features

- Easy-to-read 8-segment light bar indicator for teach and signal strength readout, plus indicators for continuous readout of operating status (user configuration)
- Easy-to-set automatic *Expert*-style configuration options include Static and Dynamic TEACH, and Window SET, plus manual adjustment for fine tuning
- Smart gain-control algorithm to maximize performance in low-contrast applications
- Fast 500-microsecond sensing response with improved crosstalk avoidance routine (for two sensors) in Normal mode
- Selectable high-speed (HS) mode option for 200-microsecond response
- Extreme configuration flexibility via push buttons or a remote input wire
- Easy selection of Light/Dark Operate (LO/DO), 30 ms pulse stretcher (OFF-delay), and response speed, via push buttons or a remote input wire
- Visible red (660 nm) or visible green (525 nm) sensing beam, depending on model
- Sleek, ultra-slim 10 mm housing, mounts to standard 35 mm DIN rail
- Models with bussable power provide simplified wiring of up to 16 sensors and feature improved temperature compensation for side-by-side mounting

† U.S. Patent(s) issued or pending

Models

Model		Description	Cable*	Outputs
Red Beam	Green Beam			
D10BFP	D10BFPG	Standard sensor	2 m (6.5') Cable	Bipolar NPN/PNP
D10BFPQ	D10BFPGQ		6-pin Pico-style QD	
Models with Bussable Power				
D10B5FP	—	Main unit	2 m (6.5') Cable	Bipolar NPN/PNP
D10B2PFP	—	Sub-unit	2 m (6.5') Cable	Single PNP
D10B2NFP	—		2 m (6.5') Cable	Single NPN

* 9 m (30') cables are available by adding suffix "W/30" to the model number of any cabled sensor (e.g., D10BFP W/30).

A model with a QD connector requires a mating cordset (see page 12).

NOTE: See page 10 for performance curves.



WARNING . . . Not To Be Used for Personnel Protection

Never use these products as sensing devices for personnel protection. Doing so could lead to serious injury or death.

These sensors do NOT include the self-checking redundant circuitry necessary to allow their use in personnel safety applications. A sensor failure or malfunction can cause either an energized or de-energized sensor output condition. Consult your current Banner Safety Products catalog for safety products which meet OSHA, ANSI and IEC standards for personnel protection.



D10 Expert™ Discrete Output with Bargraph Display

Overview

The D10 Expert is an easy-to-use, DIN-rail-mountable fiber optic sensor. It provides high-performance sensing in low-contrast applications. Configuration options include SETUP mode plus Static and Dynamic TEACH, and Window SET options, in addition to manual fine adjustment, remote programming, and security push button lockout.

The sensor's compact housing has a large, easy-to-see bargraph display plus bright LEDs for easy programming and status monitoring during operation.

Standard models have bipolar outputs, one each NPN and PNP. Main units with bussable power have the same bipolar outputs; sub-units feature a single discrete output, either NPN or PNP.

Models with bussable power are designed for use in machines and other applications where multiple sensors will be grouped tightly. They feature increased temperature compensation compared with standard models and reduce the amount of wiring necessary for such applications. An accessory clamp is available to secure a bank of connected sensors together on a DIN rail (see page 12).

Sensor Configuration

Sensor configuration is accomplished via TEACH, SET, and SETUP modes. After the sensing parameters are defined (using either TEACH or SET mode), SETUP mode may be used to enable the delay, to change the light/dark operate status, or to select the high-speed response option (HS). Manual Adjust may be used to fine-tune the thresholds (see page 8). Two push buttons, Dynamic (+) and Static (-), or the remote wire, may be used to access and set the sensing parameters.

Sensor sensitivity may be configured using any of three methods. A single switching threshold may be achieved using either Dynamic (on-the-fly) or Static TEACH; or Window SET may be used to define a sensing window, centered on a single sensing condition.

Remote Configuration

The remote configuration function may be used to configure the sensor remotely or to disable the push buttons for security. Connect the gray wire of the sensor to ground (0V dc), with a remote programming switch connected between them. Pulse the remote line according to the diagrams in the configuration procedures. The duration of the individual pulses is equal to the value T:

$$0.04 \text{ seconds} \leq T \leq 0.8 \text{ seconds}$$

Returning to RUN Mode

Some TEACH, SET, and SETUP modes may be exited either after the 60-second time-out, or by exiting the process:

- In Static TEACH or Window SET mode, press and hold the Static (-) button (or hold the remote line) for 2 seconds. The sensor returns to RUN mode without saving any new settings.
- In SETUP mode, press and hold both the Static (-) and Dynamic (+) buttons (or hold the remote line) for 2 seconds. The sensor returns to RUN mode and saves the current setting.

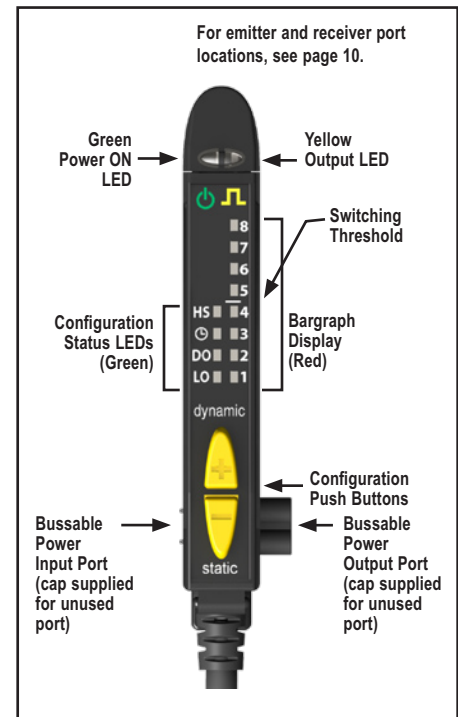

Figure 1. D10 Bargraph Model features

D10 Expert™ Discrete Output with Bargraph Display

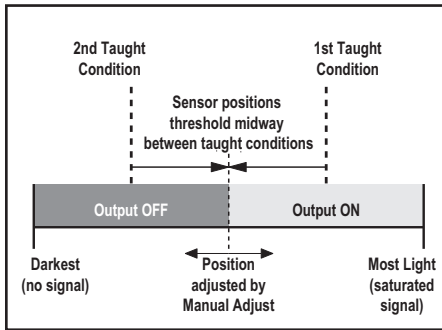

Figure 2. Static TEACH (Light Operate shown)

Bargraph LED Following TEACH	Relative Signal Difference/ Recommendation
6 to 8	Excellent: Very stable operation.
4 to 5	Good: Minor sensing variables will not affect sensing reliability.
2 to 3	Low: Minor sensing variables may affect sensing reliability.
1	Unreliable: Consider an alternate sensing scheme.

Two-Point Static TEACH (Threshold)

- Establishes a single switching threshold
- Threshold position is adjustable using “+” and “-” buttons (Manual Adjust)

Static TEACH is the traditional setup method, used when two conditions can be presented by the user. The sensor locates a single sensing threshold (the switchpoint) midway between the two taught conditions, with the Output ON condition on one side, and the Output OFF condition on the other (see Figure 2).

The first condition taught is the ON condition. The Output ON and OFF conditions can be reversed by changing Light/Dark Operate status in SETUP mode (see page 8).

Static TEACH and Manual Adjust

Using Manual Adjust with Static TEACH moves the switching threshold. The lighted LED on the bargraph will move to exhibit the received signal, relative to the switchpoint.

	Push Button 0.04 seconds ≤ “Click” ≤ 0.8 seconds	Remote Line 0.04 seconds ≤ T ≤ 0.8 seconds	Result
Access TEACH Mode	<ul style="list-style-type: none"> • Press and hold Static button > 2 seconds. 	No action required; sensor is ready for 1st TEACH condition.	Power LED: OFF Output LED: ON Status LEDs: LO & DO alternately flashing Bargraph: OFF
TEACH Output ON Condition	<ul style="list-style-type: none"> • Present Output ON condition. • Click Static button. 	<ul style="list-style-type: none"> • Present Output ON condition. • Single-pulse remote line. 	Power LED: OFF Output LED: Flash, then OFF Status LEDs: LO & DO alternately flashing Bargraph: OFF
TEACH Output OFF Condition	<ul style="list-style-type: none"> • Present Output OFF condition. • Click Static button. 	<ul style="list-style-type: none"> • Present Output OFF condition. • Single-pulse remote line. 	TEACH Accepted Power LED: ON Bargraph: One LED flashes to show relative contrast (good signal difference shown; see table above) Sensor returns to Run mode.
			TEACH Unacceptable Power LED: OFF Bargraph: #1, 3, 5, 7 alternately flash to show failure Sensor returns to “TEACH Output ON condition.”

D10 Expert™ Discrete Output with Bargraph Display

Dynamic TEACH and Adaptive Thresholds

- Teach on-the-fly
- Establishes a single switching threshold
- Threshold position is adjustable using “+” and “-” buttons (Manual Adjust)

Dynamic TEACH is best used when a machine or process may not be stopped for teaching. It programs the sensor during actual sensing conditions, taking multiple samples of the light and dark conditions and automatically setting the threshold at the optimum level (see Figure 3).

Dynamic TEACH activates the sensor’s adaptive threshold system, which continuously tracks minimum and maximum signal levels, and automatically maintains centering of the switchpoint between the light and dark conditions. The adaptive threshold system remains in effect during RUN mode. The adaptive routine saves to non-volatile memory at least once per hour.

When Dynamic TEACH mode is used, the output ON state (Light or Dark Operate) will remain as it was last programmed. To change the output ON state, use SETUP mode (see page 8).

Dynamic TEACH and Manual Adjust

The switchpoint may be adjusted (fine-tuned) whenever the sensor is in RUN mode by clicking the “+” and “-” buttons. However, when a manual adjustment is made, the adaptive threshold system is disabled (cancelled).

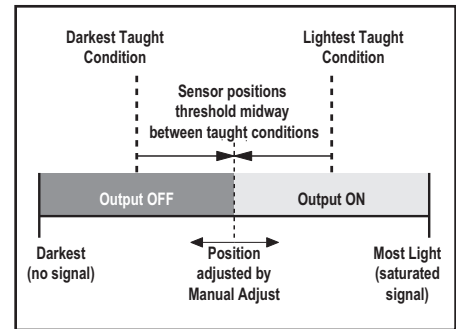

Figure 3. Dynamic TEACH (Light Operate shown)

Bargraph LED Following TEACH	Relative Signal Difference/ Recommendation
6 to 8	Excellent: Very stable operation.
4 to 5	Good: Minor sensing variables will not affect sensing reliability.
2 to 3	Low: Minor sensing variables may affect sensing reliability.
1	Unreliable: Consider an alternate sensing scheme.

	Push Button	Remote Line	Result
Access Dynamic TEACH Mode	<ul style="list-style-type: none"> • Press and Hold Dynamic push button > 2 seconds. 	<ul style="list-style-type: none"> • Hold remote line low (to ground) > 2 seconds. 	Power LED: OFF Output LED: OFF Bargraph: LO & DO alternately flashing
TEACH Sensing Conditions	<ul style="list-style-type: none"> • Continue to hold push button. • Present Output ON and OFF conditions. 	<ul style="list-style-type: none"> • Continue to hold remote line low (to ground). • Present Output ON and OFF conditions. 	Power LED: OFF Output LED: OFF Bargraph: LO & DO alternately flashing
Return to Run Mode	<ul style="list-style-type: none"> • Release push button. 	<ul style="list-style-type: none"> • Release remote line/ switch. 	<p>TEACH Accepted</p> Power LED: ON Bargraph: One LED flashes to show relative contrast (good signal difference shown; see table above) Sensor returns to Run mode with new settings. <p>TEACH Unacceptable</p> Power LED: OFF Bargraph: #1, 3, 5, 7 alternately flash to show failure Sensor returns to Run mode without changing settings.

D10 Expert™ Discrete Output with Bargraph Display

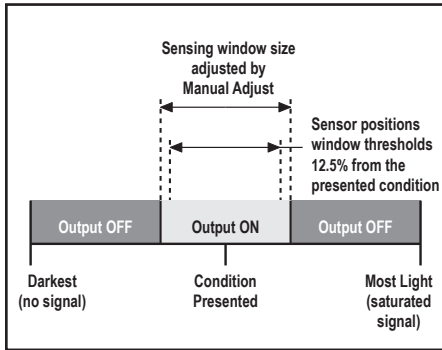

Figure 4. Window SET (Light Operate shown)

Single-Point Window SET

- Sets a single ON condition that extends 12.5% above and below the taught condition
- All other conditions (lighter or darker) result in OFF output
- Sensing window size (sensitivity) is adjustable using “+” and “-” buttons (Manual Adjust)

Window SET is most useful when a product may not always appear in the same place, or when other signals may appear. Window SET designates a sensing window, with the Output ON condition inside the window, and the Output OFF conditions outside the window (see Figure 4). The sensor accepts a single sensing condition, and adds switching thresholds above and below that condition to create a sensing window. Output ON and OFF conditions can be reversed by changing Light/Dark Operate status in SETUP mode.

Window SET and Manual Adjust

Using Manual Adjust with Window SET expands or contracts the size of the window. The lighted LEDs on the light bar separate to a greater or lesser extent to exhibit the relative sensing window size.

	Push Button 0.04 seconds ≤ “Click” ≤ 0.8 seconds	Remote Line 0.04 seconds ≤ T ≤ 0.8 seconds	Result
Access SET Mode	<ul style="list-style-type: none"> • Press and hold Static push button > 2 seconds. 	<ul style="list-style-type: none"> • Single-pulse remote line. 	Power LED: OFF Output LED: ON (Push Button) Output LED: OFF (Remote) Static LEDs: LO & DO alternately flashing
SET Sensing Condition	<ul style="list-style-type: none"> • Present sensing condition. • Double-click Static push button. 	<ul style="list-style-type: none"> • Present sensing condition. • Double-pulse remote line. 	Window Accepted Power LED: ON Bargraph: 2 indicators flash together to show Window accepted Sensor returns to RUN mode with new settings.
			Window Unacceptable Power LED: OFF Bargraph: #1, 3, 5, 7 flash to show failure Sensor returns to “SET Sensing Condition.”

D10 Expert™ Discrete Output with Bargraph Display

Single-Point Light SET

- Sets a threshold 6.25% below the taught condition.
- Any condition darker than the threshold condition causes the output to change state.
- Threshold position is adjustable using the “+” and “-” buttons (Manual Adjust).
- Recommended for applications where only one condition is known, for example a stable light background with varying darker targets.

A single sensing condition is presented, and the sensor positions a threshold 6.25% below the presented condition. When a condition darker than the threshold is sensed, the output either turns ON or OFF, depending on the Light/Dark Operate setting (see SETUP mode, page 8).

Light SET and Light/Dark Operate Selection

In Light Operate mode, Light SET teaches the Output ON condition. In Dark Operate mode, Light SET teaches the Output OFF condition.

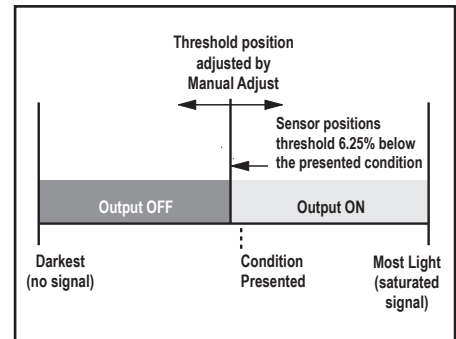

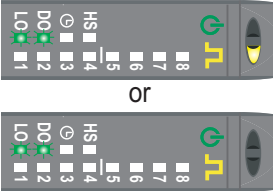
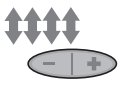

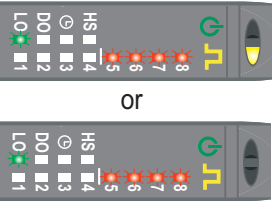
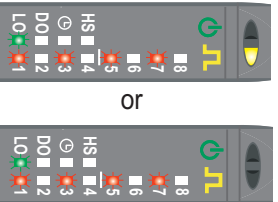

Figure 5. Single-Point Light SET (Light Operate shown)

	Push Button 0.04 seconds ≤ “Click” ≤ 0.8 seconds	Remote Line 0.04 seconds ≤ T ≤ 0.8 seconds	Result
Access SET Mode	<ul style="list-style-type: none"> • Press and hold Static push button > 2 seconds 	<ul style="list-style-type: none"> • Single-pulse remote line 	<ul style="list-style-type: none"> Power LED: OFF Output LED: ON (push button) OFF (remote line) Static LEDs: LO & DO alternately flashing 
SET Sensing Condition	<ul style="list-style-type: none"> • Present sensing condition • Four-click Static push button 	<ul style="list-style-type: none"> • Present sensing condition • Four-pulse remote line 	<p>Threshold Condition Accepted</p> <ul style="list-style-type: none"> Power LED: ON Output LED: ON (push button) OFF (remote line) Bargraph: 4 indicators flash together  <p>Sensor returns to RUN mode with new settings</p> <p>Threshold Condition Unacceptable</p> <ul style="list-style-type: none"> Power LED: ON Output LED: ON (push button) OFF (remote line) Bargraph: #1, 3, 5, 7 flash to show failure  <p>Sensor returns to “SET Sensing Condition.”</p>

D10 Expert™ Discrete Output with Bargraph Display

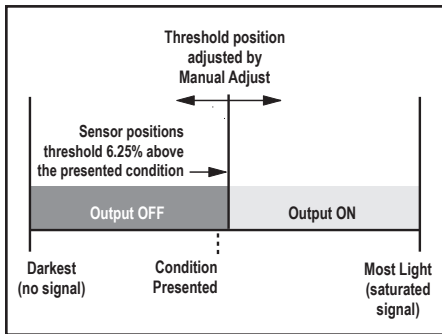

Figure 6. Single-Point Dark SET (Light Operate shown)

Single-Point Dark SET

- Sets a threshold 6.25% above the taught condition.
- Any condition lighter than the threshold condition causes the output to change state.
- Threshold position is adjustable using the “+” and “-” buttons (Manual Adjust).
- Recommended for applications where only one condition is known, for example a stable dark background with varying lighter targets.

A single sensing condition is presented, and the sensor positions a threshold 6.25% above the taught condition. When a condition lighter than the threshold is sensed, the output either turns ON or OFF, depending on the Light/Dark Operate setting (see SETUP mode, page 8).

Dark SET and Light/Dark Operate Selection

In Light Operate mode, Dark SET teaches the Output OFF condition. In Dark Operate mode, Dark SET teaches the Output ON condition.

	Push Button 0.04 seconds ≤ “Click” ≤ 0.8 seconds	Remote Line 0.04 seconds ≤ T ≤ 0.8 seconds	Result
Access SET Mode	<ul style="list-style-type: none"> • Press and hold Static push button > 2 seconds 	<ul style="list-style-type: none"> • Single-pulse remote line 	<p>Power LED: OFF Output LED: ON (push button) OFF (remote line) Static LEDs: LO & DO alternately flashing</p> <p>OR</p>
SET Sensing Condition	<ul style="list-style-type: none"> • Present sensing condition • Five-click Static push button 	<ul style="list-style-type: none"> • Present sensing condition • Five-pulse remote line 	<p>Threshold Condition Accepted</p> <p>Power LED: ON Output LED: ON (push button) OFF (remote line) Bargraph: 4 indicators flash together</p> <p>Sensor returns to RUN mode with new settings</p> <p>OR</p> <p>Threshold Condition Unacceptable</p> <p>Power LED: ON Output LED: ON (push button) OFF (remote line) Bargraph: #1, 3, 5, 7 flash to show failure</p> <p>Sensor returns to “SET Sensing Condition.”</p> <p>OR</p>

D10 Expert™ Discrete Output with Bargraph Display

SETUP Mode

SETUP mode is used to change sensor output response for:

- Light or Dark operate
- 30-millisecond pulse stretcher (OFF-delay), if required.
- 200 μ s high-speed response

If SETUP mode configuration is interrupted and remains inactive for 60 seconds, the sensor returns to RUN mode with the most recent settings (i.e., exits and saves current selection).

SETUP mode operates in the “background,” while the outputs are active; changes are updated instantly.

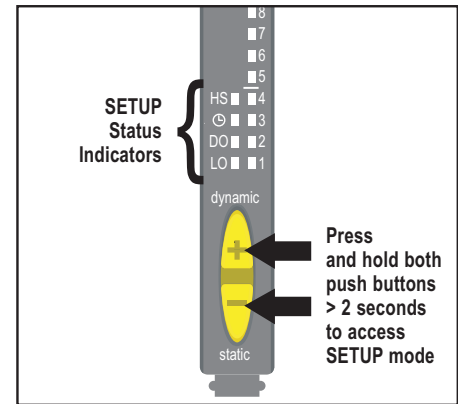

Figure 7. SETUP mode

	Push Button 0.04 seconds \leq “Click” \leq 0.8 seconds	Remote Line 0.04 seconds \leq T \leq 0.8 seconds	Result
Access SETUP Mode	<ul style="list-style-type: none"> • Press and hold both push buttons > 2 seconds. 	<ul style="list-style-type: none"> • Double-pulse remote line. 	<ul style="list-style-type: none"> • Green Power LED turns OFF. • Output LED remains active. • Icons continue to display current setup. • Bargraph turns OFF.
Select Setting Combination	<ul style="list-style-type: none"> • Click either push button until LEDs show desired settings. 	<ul style="list-style-type: none"> • Pulse the remote line until LEDs show desired settings. <p>NOTE: Double-pulsing the remote line will cause the setting to “back up” one step.</p>	<p>Sensor toggles through eight setting combinations, in the following order:</p> <ul style="list-style-type: none"> LO - Normal Speed - No Delay (default) DO - Normal Speed - No Delay LO - High Speed - No Delay DO - High Speed - No Delay LO - Normal Speed - Delay DO - Normal Speed - Delay LO - High Speed - Delay DO - High Speed - Delay
Return to RUN Mode	<ul style="list-style-type: none"> • Press and hold both push buttons > 2 seconds. 	<ul style="list-style-type: none"> • Hold remote line low > 2 seconds. 	<ul style="list-style-type: none"> • Green Power LED turns ON. • Sensor returns to RUN mode with new settings.

Manual Adjust

Manual Adjust is used during RUN mode and is accomplished via the push buttons only. Its behavior depends on whether a switching threshold or a sensing window is used.

Switching Threshold:

- Fine-tunes sensing sensitivity
- Press “+” to increase; press “-” to decrease

Sensing Window:

- Adjusts sensing window size (tolerance) for the single-point target condition
- Press “+” to increase; press “-” to decrease

The lighted bargraph LEDs move to reflect the increase or decrease.

Push Button Disable

In addition to its configuration function, the remote input may be used to disable the push buttons for security. Disabling the push buttons prevents undesired tampering with the configuration settings. Connect the gray wire of the sensor as described on page 2, and four-pulse to either enable or disable the push buttons:



D10 Expert™ Discrete Output with Bargraph Display

Specifications

	Standard Sensors	Models with Bussable Power
Sensing Beam	660 nm visible red or 525 nm visible green, depending on model	660 nm visible red
Supply Voltage	10 to 30V dc (10% max. ripple) @ less than 45 mA exclusive of load	12 to 30V dc (10% max. ripple) @ less than 45 mA exclusive of load
Supply Protection Circuitry	Protected against reverse polarity, over voltage, and transient voltages	
Delay at Power Up	200 milliseconds max.; outputs do not conduct during this time	850 milliseconds max.; outputs do not conduct during this time
Output Configuration	Bipolar; 1 current sourcing (PNP) and 1 current sinking (NPN)	Main units: Bipolar; 1 current sourcing (PNP) and 1 current sinking (NPN) Sub-units: 1 current sourcing (PNP) or 1 current sinking (NPN) output, depending on model
Output Rating	150 mA max. load @ 25° C (derate 1 mA per °C increase) OFF-state leakage current: < 5 µA at 30V dc ON-state saturation voltage: NPN: < 200 mV @ 10 mA; 1V @ 150 mA load PNP: < 1V @ 10 mA; 1.5V @ 150 mA load	100 mA max. load (derate 1 mA per °C above 30° C) OFF-state leakage current: < 5 µA at 30V dc ON-state saturation voltage: NPN: < 1.5V PNP: < 2V Supply 15V or more: up to 16 units with 100 mA outputs Less than 15V supply (9 m cable): up to 4 units with 100 mA outputs up to 8 units with 50 mA outputs
Output Protection	Protected against output short-circuit, continuous overload, transient over-voltages, and false pulse on power up	
Output Response Time	500 microseconds (normal mode) or 200 microseconds (high-speed mode)	
Repeatability	100 microseconds (normal mode) or 66 microseconds (high-speed mode)	
Adjustments	2 push buttons and remote wire <ul style="list-style-type: none"> Expert-style configuration (Static and Dynamic TEACH, and Window SET) Manually adjust (+/-) sensitivity (from push buttons only) LO/DO, OFF-delay, and response speed configurable (from push buttons or remote wire) Push button lockout (from remote wire only) Factory Default Settings: Light Operate, Normal Speed, No Delay	
Indicators	8-segment red bargraph: Light-to-dark signal difference relative to taught condition (Window SET) Sensing contrast (Static or Dynamic TEACH) Green Status Indicators: LO, DO, High Speed (HS), and OFF-Delay Green LED: Power ON Yellow LED: Output conducting	
Construction	Black ABS/polycarbonate alloy (UL94 V-0 rated) housing, clear polycarbonate cover	
Environmental Rating	IEC IP50, NEMA 1	
Connections	PVC-jacketed 2 m or 9 m (6.5' or 30') 6-wire integral cable or integral 6-pin Pico-style quick-disconnect	Main units: PVC-jacketed 2 m or 9 m (6.5' or 30') 5-wire integral cable Sub-units: PVC-jacketed 2 m or 9 m (6.5' or 30') 2-wire integral cable
Operating Conditions	Temperature: -10° to +55° C (+14° to 131° F) Storage: -20° to +85° C (-4° to +185° F) Relative Humidity: 90% @ 55° C (non-condensing)	
Certifications	 (CE approval is pending for models with bussable power)	

D10 Expert™ Discrete Output with Bargraph Display

Performance Curves

Red Beam Models

Opposed Mode

Diffuse Mode

Performance based on 90% reflectance white test card

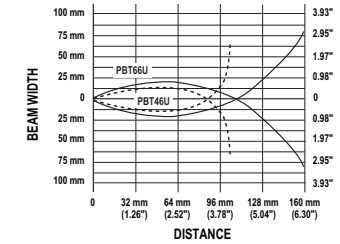
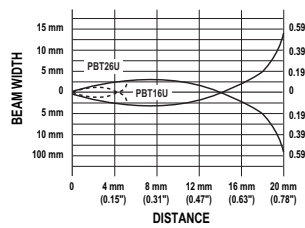
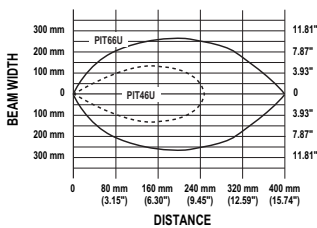
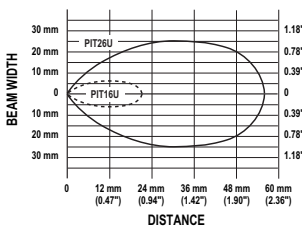
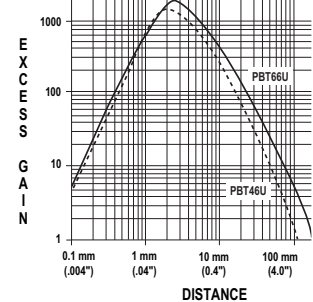
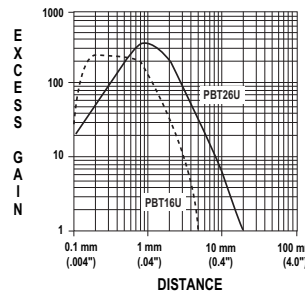
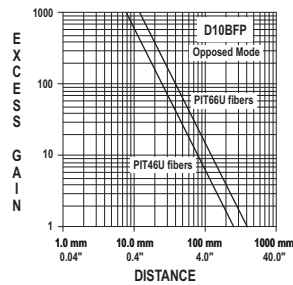
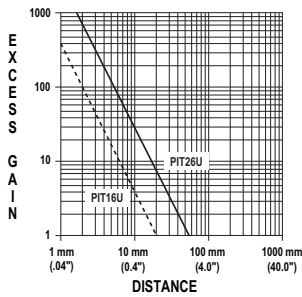

Green Beam Models

Opposed Mode

Diffuse Mode

Performance based on 90% reflectance white test card

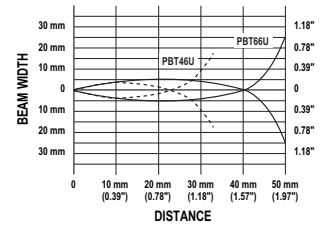
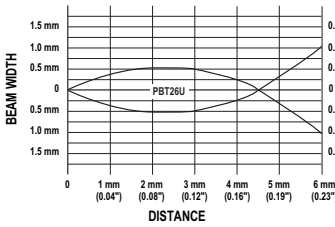
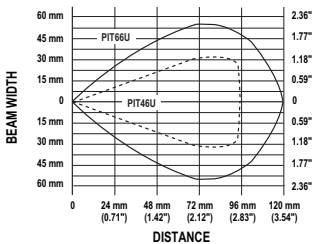
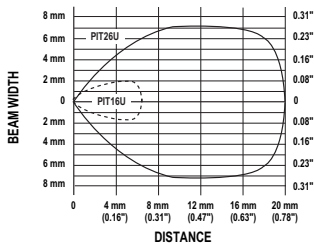
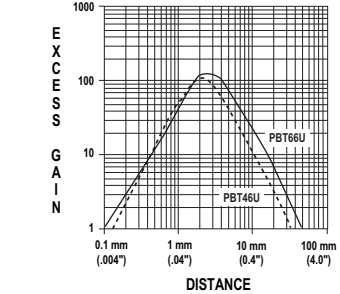
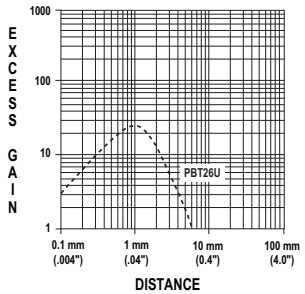
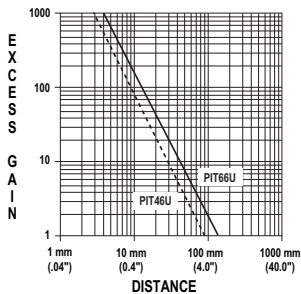
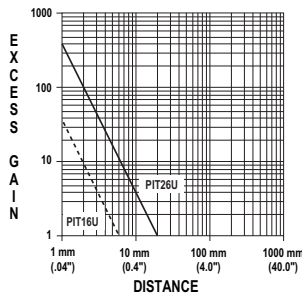

D10 Expert™ Discrete Output with Bargraph Display

Dimensions

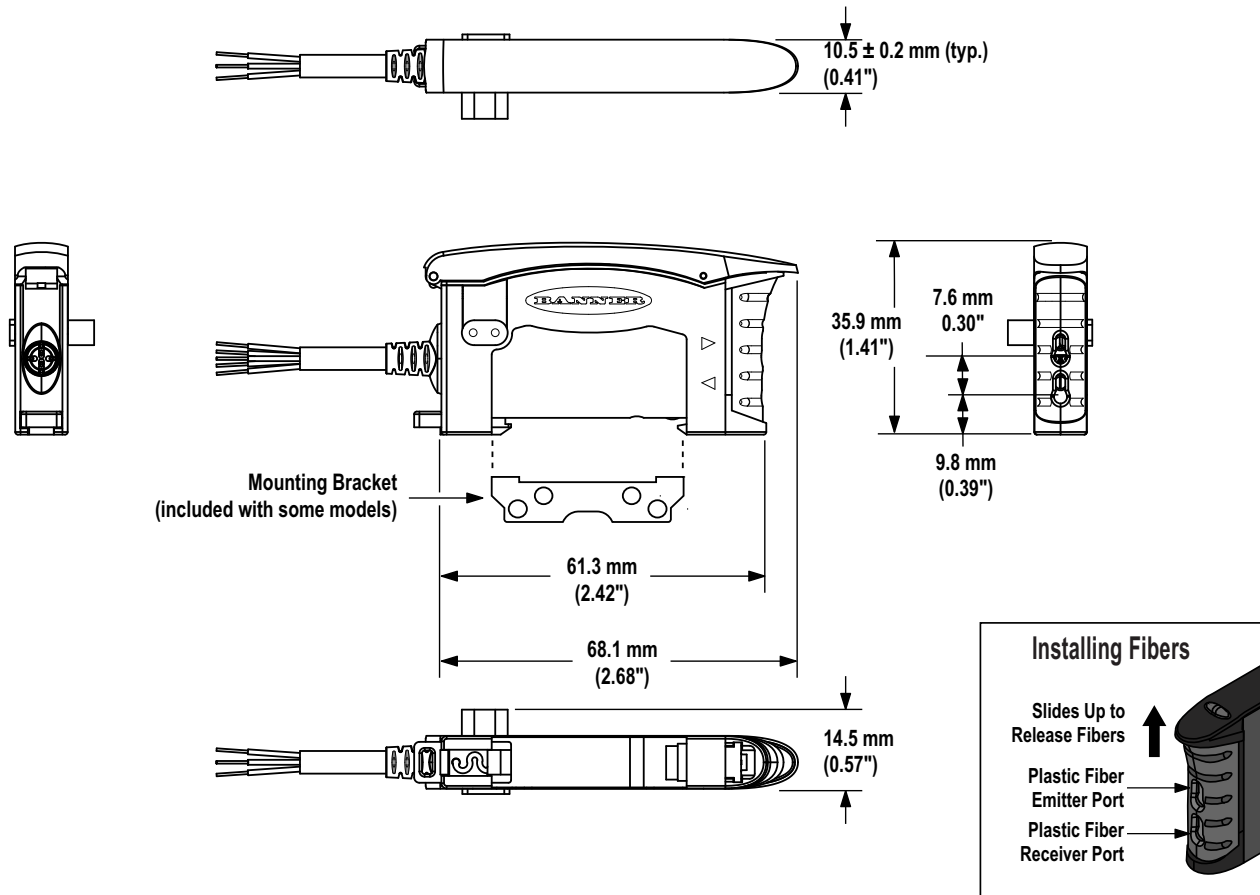

Bracket Dimensions (Bracket included with Standard Sensor Models)

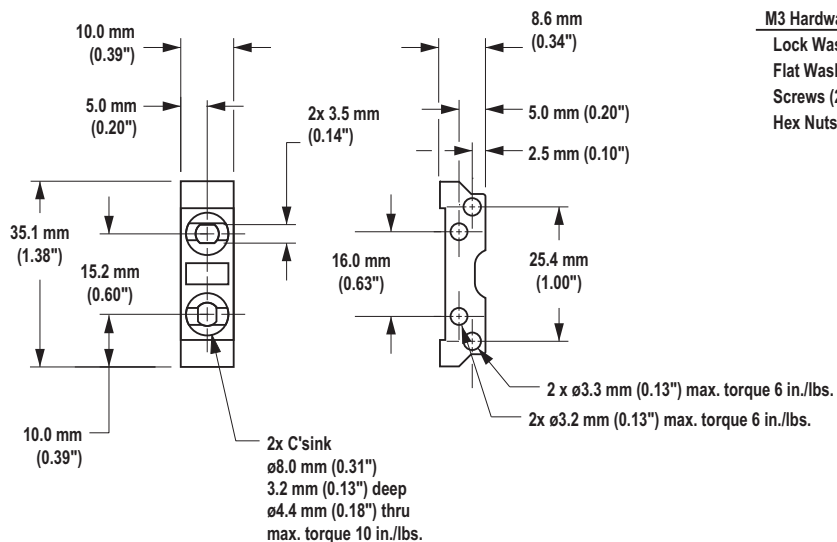

D10 Expert™ Discrete Output with Bargraph Display

Hookups

Standard Models and Main Unit

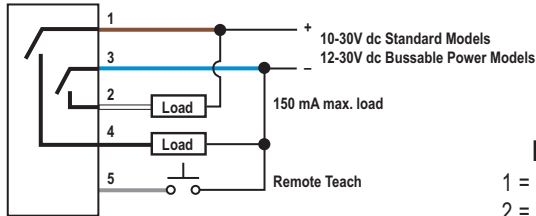

NOTE: QD hookup is functionally identical (Pink wire not used).

Key
 1 = Brown
 2 = White
 3 = Blue
 4 = Black
 5 = Gray
 6 = Pink†
 † Not Used

Sub-Units

NPN

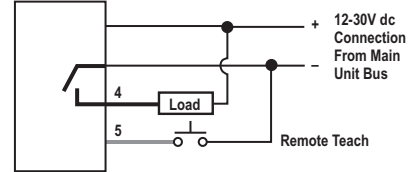

PNP

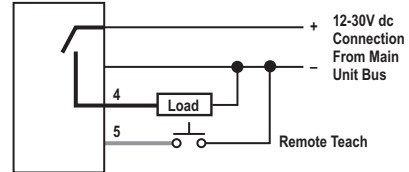

Quick-Disconnect Cordsets

Style	Model	Length	Dimensions	Pinout
6-pin Pico-style straight	PKG6Z-2 PKG6Z-9	2 m (6.5') 9 m (30')		
6-pin Pico-style right-angle	PKW6Z-2 PKW6Z-9	2 m (6.5') 9 m (30')		

Accessories

SA-DIN-CLAMP

- Pair of metal DIN rail end stops; slide onto DIN rail at either side of D10B sensor stack; holds bussable power models together to maintain electrical connection
- Combination (#2 Phillips, #8 standard slotted) set screw

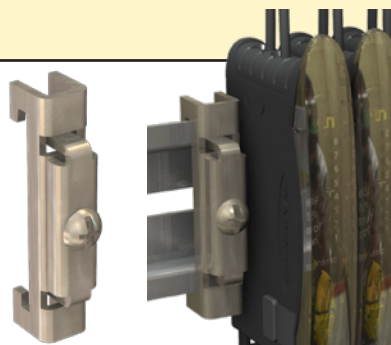
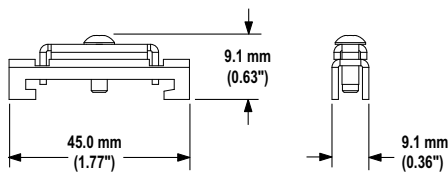
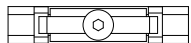

SA-D10B-CAP

- Package of 5 each replacement terminal caps and plugs to cover beginning and end of stack of connected sensors



BANNER
 more sensors, more solutions

WARRANTY: Banner Engineering Corp. warrants its products to be free from defects for one year. Banner Engineering Corp. will repair or replace, free of charge, any product of its manufacture found to be defective at the time it is returned to the factory during the warranty period. This warranty does not cover damage or liability for the improper application of Banner products. This warranty is in lieu of any other warranty either expressed or implied.

P/N 117830 rev. E

Banner Engineering Corp., 9714 Tenth Ave. No., Minneapolis, MN USA 55441 • Phone: 763.544.3164 • www.bannerengineering.com • Email: sensors@bannerengineering.com