

Inductive Sensors

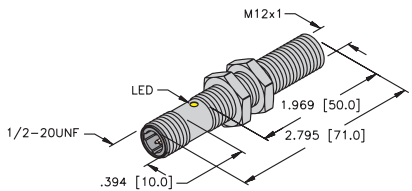
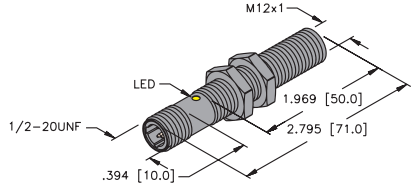
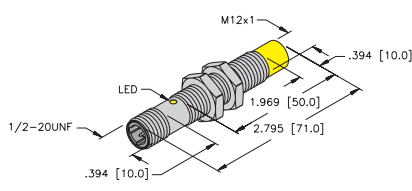
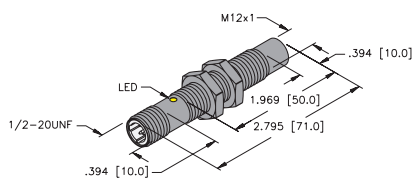
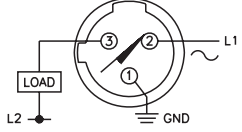

Housing Style	Part Number	ID Number	Features	Sensing Range (mm)	Output	
12 mm - Embeddable, <i>microfast</i>® Connection 	Bi 2-G12-ADZ32X-B3131	T4205001		2	2-Wire AC/DC Short-circuit Protected	
	Bi 2U-G12-ADZ32X-B3131	M4281005	<i>Uprox</i>	2		
	Bi 4-G12-ADZ32X-B3131	T4205031	<i>Ext. Range</i>	4		
		Bi 2-G12-AZ33X-B3131	T1304032		2	2-Wire AC/DC
12 mm - Embeddable, <i>microfast</i> Connection, Teflon Coated 	Bi 2-GT12H-ADZ32X-B3131/S34	T4205093	<i>WFI</i>	2	2-Wire AC/DC Short-circuit Protected	
	Bi 2-GT12H-ADZ32X-B3131/S34/S1589	T4205096	<i>WFI</i>	2		
	Bi 2-GT12-ADZ32X-B3131/S34	T4205005	<i>WFI</i>	2		
	Bi 2U-GT12-ADZ32X-B3131	M4281015	<i>Uprox</i>	2		
		Bi 4-GT12H-ADZ32X-B3131	T4205097	<i>Stoneface</i>	4	2-Wire AC/DC
		Bi 4-GT12H-ADZ32X-B3131/S1589	T4205087	<i>weldguard</i> ®	4	
12 mm - Nonembeddable, <i>microfast</i> Connection 	Ni 4-G12-ADZ32X-B3131	T4205201		4	2-Wire AC/DC Short-circuit Protected	
	Ni 8-G12-ADZ32X-B3131	M4205401	<i>Ext. Range</i>	8		
	Ni 8U-G12-ADZ32X-B3131	M4281105	<i>Ext. Range, Uprox</i>	8		
		Ni 4-G12-AZ33X-B3131	T1304232		4	2-Wire AC/DC
12 mm - Nonembeddable, <i>microfast</i> Connection, Teflon Coated 	Ni 4-GT12-ADZ32X-B3131/S34	T4205205	<i>WFI</i>	4	2-Wire AC/DC	
	Ni 4-GT12-AZ33X-B3131/S34	T1304292	<i>WFI</i>	4		
	Ni 4-GT12H-ADZ32X-B3131/S34/S1589	T4205293	<i>weldguard</i>	4		
	Ni 8-GT12H-ADZ32X-B3131/S1589	T4205480-1	<i>weldguard</i>	8		
	Ni 8U-GT12-ADZ32X-B3131	M4281115	<i>Uprox</i>	8		

Voltage	Switching Freq. (Hz)	Operating Current (mA)	Operating Temp. (°C)	Protection	Housing	Face	Power LED	Output LED	Mating Cordset	Wiring Diagram #	Wiring Diagrams
20-250 VAC 10-300 VDC	20	≤100	-25 to +70	IP 67	CPB	PA 12	N/A	YE	KB 3T-*	1	<p>Diagram 1</p> 
	20	≤100	-30 to +85	IP 67	CPB	PA 12	N/A	YE	KB 3T-*	1	
	20	≤100	-25 to +70	IP 67	CPB	PA 12	N/A	YE	KB 3T-*	1	
20-250 VAC 10-300 VDC	20	≤100	-25 to +70	IP 67	TC	TC	N/A	YE	KB 3T-*	1	
	20	≤100	-25 to +70	IP 67	TC	WG	N/A	YE	KB 3T-*	1	
	20	≤100	-25 to +70	IP 67	TC	TC	N/A	YE	KB 3T-*	1	
	20	≤100	-30 to +85	IP 67	TC	TC	N/A	YE	KB 3T-*	1	
	20	≤100	-25 to +70	IP 67	TC	TC	N/A	YE	KB 3T-*	1	
	20	≤100	-25 to +70	IP 67	TC	TC	N/A	YE	KB 3T-*	1	
20-250 VAC 10-300 VDC	20	≤100	-25 to +70	IP 67	TC	TC	N/A	YE	KB 3T-*	1	
20-250 VAC 10-300 VDC	20	≤100	-25 to +70	IP 67	CPB	PA 12	N/A	YE	KB 3T-*	1	
	20	≤100	-25 to +70	IP 67	CPB	PA 12	N/A	YE	KB 3T-*	1	
	20	≤100	-30 to +85	IP 67	CPB	PA 12	N/A	YE	KB 3T-*	1	
20-250 VAC 10-300 VDC	20	≤100	-25 to +70	IP 67	CPB	PA 12	N/A	YE	KB 3T-*	1	
20-250 VAC 10-300 VDC	20	≤100	-25 to +70	IP 67	TC	PA 12	N/A	YE	KB 3T-*	1	
	20	≤100	-25 to +70	IP 67	TC	PA 12	N/A	YE	KB 3T-*	1	
	20	≤100	-25 to +70	IP 67	TC	WG	N/A	YE	KB 3T-*	1	
	20	≤100	-25 to +70	IP 67	TC	WG	N/A	YE	KB 3T-*	1	
	20	≤100	-30 to +85	IP 67	TC	PA 12	N/A	YE	KB 3T-*	1	

* Length in meters.

WIRING DIAGRAMS



WARNING: NO SHORT-CIRCUIT PROTECTION
ALWAYS WIRE A LOAD IN SERIES WITH THE SENSOR

LOCKNUT LN-M12

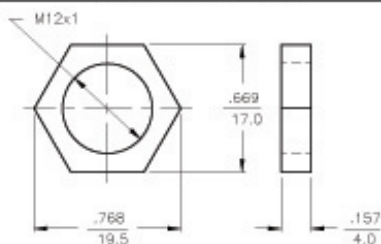

SPECIFICATIONS

OPERATING VOLTAGE	35-250 VAC/DC
LINE FREQUENCY	40-60 Hz
DIFFERENTIAL TRAVEL (HYSTERESIS)	3-15% (5% TYPICAL)
VOLTAGE DROP ACROSS CONDUCTING SENSOR	≤ 11.0 V at 200 mA
OUTPUT FUNCTION -AZ	NORMALLY OPEN 2-WIRE AC SELF-CONTAINED
SHORT-CIRCUIT PROTECTED	NO
CONTINUOUS LOAD CURRENT	≤ 200 mA
OFF-STATE (LEAKAGE) CURRENT	≤ 1.7 mA
MINIMUM LOAD CURRENT	≥ 5.0 mA
INRUSH CURRENT	≤ 1.0 A (≤ 10 ms/5 Hz)
TIME DELAY BEFORE AVAILABILITY	≤ 8 ms
POWER-ON EFFECT PROTECTION	INCORPORATED
PROTECTION AGAINST TRANSIENTS	5 kV, 10 ms, 10 kΩ
OPERATING TEMPERATURE	-25°C to +70°C (-13°F to +158°F)
ENCLOSURE	MEETS NEMA 1, 3, 4, 6, 13 AND IEC IP67
SHOCK	30 g, 11 ms
VIBRATION	55 Hz, 1 mm AMPLITUDE (IN ALL 3 PLANES)
LED FUNCTION	RED: OUTPUT ENERGIZED
RATED OPERATING DISTANCE(Sn)	2 mm = .079" (NOMINAL)
SWITCHING FREQUENCY	20 Hz
REPEATABILITY	≤ 2% of RATED OPERATING DISTANCE
EMBEDDABLE (SHIELDED)	YES
MATING PLUGS/CABLES	3-PIN "MICROFAST" CONSTRUCTION

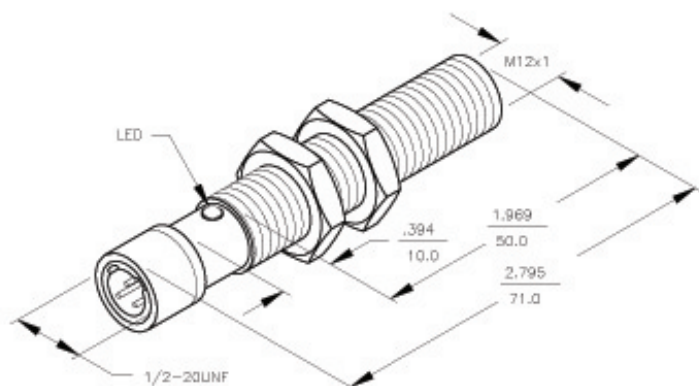

RELATED DOCUMENTS 1. 2. 3. 4.	3RD ANGLE PROJECTION 	THIS DRAWING IS PROPERTY OF TURCK INC. USE OF THIS DOCUMENT WITHOUT WRITTEN PERMISSION IS PROHIBITED.	TURCK INC High Technology Sensors and Automation Controls	
MATERIAL BRASS BARREL	TOLERANCES UNLESS OTHERWISE SPECIFIED .X ± 0.02 .XX ± 0.01 .XXX ± 0.005 ANGLES ± 1° ALL MILLIMETER DIMENSIONS ARE REFERENCED ONLY	DRAWN SWC DATE 8/2/94 SCALE NONE	DESCRIPTION Bi2-G12-AZ33X-B3131	
FINISH COPPER/NICKEL/ CHROME PLATING		UNIT OF MEASUREMENT INCH [MILLIMETER]	IDENTIFICATION NO. T1304032	REV D
D UPDATE OPERATING VOLTAGE, SEE ECO	RWC 08/08/07 18320	DO NOT SCALE THIS DRAWING	FILE: T1304032	SHEET 1 OF 1
REV DESCRIPTION	BY DATE EDO NO.			