

[Home](#) > [Products](#) > [PLCs](#) > MicroSmart

Micro PLCs MicroSmart



Overview

IDEC MicroSmart series PLC is the next generation of programmable logic controller. These flexible, adaptable PLCs are as compact as they are powerful, so you can create the system you need without increasing your space requirements or your budget.

MicroSmart CPUs are available with built-in 10, 16, and 24 I/O All-In-One units, and 20 and 40 I/O slim style models.

Each MicroSmart CPU is designed in a compact and rugged housing. Every MicroSmart module meets IDEC strict quality standards and complies with all major international standards; cULus, CE, TUV, and Lloyds.

Each CPU is equipped with a standard power supply circuit, four high-speed counters, analog potentiometer, and password protection.

The Slim type and the 24 I/O All-in-one CPU can be expanded with the many choices of expansion

modules. There are 20 modules available including four analog I/O modules, an AS-interface master communication module, and our most recent addition to the MicroSmart family, the 8-pt AC input module. In addition, 24V DC All-in-one CPUs are now available. Depending upon the CPU, you can create a system with as many as 264 I/Os.

Each MicroSmart module can be enhanced with a memory cartridge for easy maintenance, a real-time clock and calendar cartridge for real time applications, and an RS-485/RS-232 communications adapter. These adapters allow the MicroSmart CPU to data link to the MicroSmart or other IDEC PLCs, connect to operator interfaces, printers, barcode readers, or other RS-232 devices such as modems for remote communication.

MicroSmart PLCs are programmable with WindLDR, IDEC's intuitive ladder logic software. The current WindLDR version 5.03 has improved features such as a split ladder window for easy navigation, improved tag name editor and rung comment search. Download your free demo now or upgrade to WindLDR 5.03 if you have version 4.0 or later.

Key Features

- Available in Slim or All-In-One styles
- CPU units are equipped with 10, 16, 20, 24, or 40 I/Os.
- Maximum of 264 I/Os can be configured on a single MicroSmart CPU
- Your choice of many expansion modules: AC/DC inputs, relay/transistor outputs, RTD/ Thermocouple and Analog I/Os, and AS-interface Master communication module
- Standard RS232 port, optional plug-in RS485/RS232 port for data link or modem communications
- Optional plug-in HMI module for monitoring, memory cartridge, and real-time clock and calendar cartridge
- Built in Modbus-CRC, PID and Ramp functions
- 4 built-in high speed counters, interrupt and catch inputs, and password protection
- Data link for up to 32 MicroSmart or other IDEC PLCs
- cULus, CE, TUV and Lloyds approved
- Approved for Class 1 Div 2 Hazardous Locations
- Easy programming using IDEC exclusive WindLDR software
- New web server module for faster, easier ethernet connectivity

MicroSmart Series

FC4A-D20K3

[The MicroSmart is available in either Slim type or the All-In-One type with expandability up to 264 I/O.]



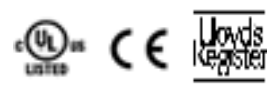

Product Specifications

PLC Product Category CPU Unit

Operating Voltage 24V DC

Maximum PID Loops 14

High Speed Counter(s) 20kHz, 5kHz

High Speed Counter Input Type Sink, Source

RS485 Ports 1, Separate Module Required

On Board Communication Port 1 RS-232

Memory Card Slot Yes

On Board Input Type Transistor Sink, Transistor Source

On Board Output Type Transistor Sink

I/O Expandable Yes

Maximum I/O 148

On Board I/O 12/8

Real Time Clock Yes, Separate Module Required

Connector Type Ribbon Cable

Notes MicroSmart Slim/Book Style PLC. Expandable with Snap on I/O cards. See catalog pages for more details.

I/O Range Requirement 24 or less, 25-88, 89-148

Floating Point Math No

Data Processing 16 Bit

Max. Communication Ports 1, 2

Maximum Analog Points 14 Input / 7 Output

MicroSmart CPU Part Numbers

Appearance	Part Number	Power	I/O Points	Input	Output	Expandability			
	FC4A-D20RK1	24V DC	20 (12 in/8 out)	24V DC (Sink/Source)	6 Relays, 2 Transistor Sink	244 Maximum I/O (up to 7 expansion modules)			
	FC4A-D20RS1				6 Relays, 2 Transistor Source				
	FC4A-D20K3				Transistor Sink	148 Maximum I/O (up to 7 expansion modules)			
	FC4A-D20S3				Transistor Source				
	FC4A-D40K3				40 (24 in/16 out)			Transistor Sink	264 Maximum I/O (up to 7 expansion modules)
	FC4A-D40S3							Transistor Source	

PLCs

Operator Interfaces

Automation Software

Power Supplies

Sensors

Communication & Networking

Slim

Part Number		FC5A-D16RK1 FC5A-D16RS1	FC5A-D32K3 FC5A-D32S3	FC4A-D20K3 FC4A-D20S3	FC4A-D20RK1 FC4A-D20RS1	FC4A-D40K3 FC4A-D40S3					
Control System		Stored program system									
Instruction Words		35 basic									
Program Capacity ¹		88 advanced	92 advanced	55 advanced	72 advanced						
User Program Storage		EEPROM (10,000 times rewritable)									
Processing Time	Basic Instruction	83µs (1,000 steps)			1.65ms (1,000 steps)						
	END Processing ³	0.35ms			0.64ms						
Expandable I/O Modules		7 modules + additional 8 modules using the expansion power supply module			7 modules						
I/O Points	Input	8	Expansion: 224 Additional: 256	16	Expansion: 224 Additional: 256	12	Expansion: 128	12	Expansion: 224	24	Expansion: 224
	Output	8	Expansion: 224 Additional: 256	16	Expansion: 224 Additional: 256	8	Expansion: 128	8	Expansion: 224	16	Expansion: 224
Internal Relay		2,048 points			1,024 points						
Shift Register		256 points			128 points						
Data Register		42,000 points ⁴			1,300 points						
Expansion Data Register		6,000 points			—			6,000 points			
Counter		256 points			100 points						
Timer (1-sec, 100-ms, 10-ms, 1-ms)		256 points			100 points						
RAM Backup	Backup Data	Internal relay, shift register, counter, data register, expansion data register									
	Backup Duration	Approx. 30 days (typical) at 25°C after backup battery fully charged									
	Battery	Lithium secondary battery									
	Charging Time	Approx. 15 hours for charging from 0% to 90% of full charge									
	Battery Life	5 years									
Replaceability		N/A									
Self-diagnostic Function		Power failure, watchdog timer, data link connection, user program EEPROM sum check, timer/counter preset value sum check, user program RAM sum check, keep data, user program syntax, user program writing, CPU module, clock IC, I/O bus initialize, user program execution									
Input Filter		Without filter or 3 to 15ms filter (selectable in increments of 1ms)									
Catch Input/Interrupt Input		Four inputs (I2 through I5) Minimum turn on pulse width: 5µs minimum Minimum turn off pulse width: 5µs minimum			Four inputs (I2 through I5) Minimum turn on pulse width: 40µs minimum Minimum turn off pulse width: 150µs minimum						
High-speed Counter	Maximum Counting Frequency and High-speed Counter Points	Total 4 points Single/two-phase selectable: 100 KHz (2 points) Single-phase: 100 KHz (2 points)			Total 4 points Single/two-phase selectable: 20 KHz (2 points) Single-phase: 5 KHz (2 points)						
	Counting Range	0 to 4294967295 (32 bits)			0 to 65535 (16 bits)						
	Operation Mode	Rotary encoder mode and adding counter mode									
Analog Potentiometer	Number	1 point									
	Data Range	0 to 255									
Analog Voltage Input	Number	1 point									
	Input Voltage Range	0 to 10V DC									
	Input Impedance	Approx. 100kΩ									
	Data Range	0 to 255 (8 bits)									
Pulse Output	Number	2 points	3 points	2 points							
	Maximum Frequency	100KHz			20KHz						
Sensor Power Supply	Output Voltage Current	—									
	Overload Detection	—									
	Isolation	—									
Port 1		RS232C (maintenance communication, user communications)									
Port 2 Communication Adapter (option) ⁵		Possible	Possible	Possible	Possible	Possible					
Clock Cartridge (option)		Possible	Possible	Possible	Possible	Possible					
Memory Cartridge (option)		Possible	Possible	Possible	Possible	Possible					
HMI Module (option)		Possible	Possible	Possible	Possible	Possible					



- 1 step equals 6 bytes.
- Expandable up to 64 KB when a memory cartridge is used.
- Not including expansion I/O service time, clock function processing time, data link processing time, and interrupt processing time.
- Extra data registers D10000 through D49999 are enabled using WindLDR

- Function Area Settings, then run-time program download cannot be used.
- Maintenance communication, user communication, Modem communication, data link, Modbus master/slave communication (FC5A only).
- Note: The maximum number of relay outputs that can be turned on simultaneously is 54 including those on the CPU module.

PLCs

Operator Interfaces

Automation Software

Power Supplies

Sensors

Communication & Networking

Communication Port (RS232C Port 1)

Model	Slim CPU	All-in-One CPU
Standards	EIA RS232C	
Maximum Baud Rate	FC5A: 57,600 bps (maintenance communication) FC4A: 19,200 bps (maintenance communication)	
Maintenance Communication	Possible	
User Communication	Possible	
Modem Communication	N/A	
Data Link	N/A	
Cable	Special cable (FC2A-KC4C, FC2A-KP1C, FC4A-KC1C, FC4A-KC2C)	
Isolation between Internal Circuit and Communication Port	Not isolated	

Input Specifications

Part Number	—	FC5A-D16RK1 FC5A-D16RS1	—	FC5A-D32K3 FC5A-D32S3	—	FC5A-C10R2 FC5A-C10R2C	FC5A-C16R2 FC5A-C16R2C	FC5A-C24R2 FC5A-C24R2C
	FC4A-D20K3 FC4A-D20S3	—	FC4A-D20RK1 FC4A-D20RS1	—	FC4A-D40K3 FC4A-D40S3	FC4A-C10R2 FC4A-C10R2C	FC4A-C16R2 FC4A-C16R2C	FC4A-C24R2 FC4A-C24R2C
Input Points	12 (12/1 common)	8 (8/1 common)	12 (12/1 common)	16 (8/1 common)	24 (12/1 common)	6 (6/1 common)	9 (9/1 common)	14 (14/1 common)
Input Voltage	24V DC sink/source input signal							
Input Voltage Range	20.4 to 26.4V DC					20.4 to 28.8V DC		
Input Current	FC5A I0, I1, I3, I4, I6, I7: 4.5mA/point (24V DC) I2, I5, I10 to I17: 7mA/point (24V DC) FC4A I0, I1, I6, I7: 5mA/point (24V DC) I2 to I5, I10 to I27: 7mA/point (24V DC)					FC5A I0 and I1: 6.4mA/point I2 to I7, I10 to I15: 7mA/point (24V DC) FC4A I0 and I1: 11mA I2 to I7, I10 to I15: 7mA/point (24V DC)		
Input Impedance	FC5A I0, I1, I3, I4, I6, I7: 4.9kΩ I2 to I5, I10 to I17: 3.4kΩ FC4A I0, I1, I6, I7: 5.7kΩ I2 to I5, I10 to I17: 3.4kΩ					FC5A I0 and I1: 3.7kΩ I2 to I7, I10 to I15: 3.4kΩ FC4A I0 and I1: 2.1kΩ I2 to I7, I10 to I15: 3.4kΩ		
Turn ON Time	FC5A I0, I1, I3, I4, I6, I7: 5μs + filter value I2 and I5: 35μs + filter value I10 to I17: 40μs + filter value FC4A I0, I1, I6, I7: 35μs + filter value I2 to I5: 35μs + filter value I10 to I27: 40μs + filter value					FC5A I0 and I1: 2μs + filter value I2 to I7: 35μs + filter value I6, I7, I10 to I15: 40μs + filter value FC4A I0 and I1: 35μs + filter value I2 to I5: 35μs + filter value I6, I7, I10 to I15: 40μs + filter value		
Turn OFF Time	FC5A I0, I1, I3, I4, I6, I7: 5μs + filter value I2 and I5: 150μs + filter value I10 to I17: 150μs + filter value FC4A I0, I1, I6, I7: 45μs + filter value I2 to I5: 150μs + filter value I10 to I27: 150μs + filter value					FC5A I0 and I1: 16μs + filter value I2 to I7: 150μs + filter value I6, I7, I10 to I15: 150μs + filter value FC4A I0 and I1: 45μs + filter value I2 to I5: 150μs + filter value I6, I7, I10 to I15: 150μs + filter value		
Connector	On Mother Board	FL26A2MA (Oki Electric Cable)	MC1.5/18-G-3.81BK (Phoenix Contact)	FL26A2MA (Oki Electric Cable)	—			
	Insertion Durability	100 times minimum					—	
Isolation	Between input terminals: Photocoupler isolated Internal circuit: Not isolated							
Input	Type 1 (IEC61131-2)							
External Load for I/O Interconnection	Not needed							
Single Determination Method	Static							
Effect of Improper Input Connection	Both sinking and sourcing input signals can be connected. If any input exceeding the rated value is applied, permanent damage may be caused.							
Cable Length	3 m in compliance with electromagnetic immunity							

PLCs

Operator Interfaces

Automation Software

Power Supplies

Sensors

Communication & Networking

Transistor Sink and Source Output

Part Number	—	FC5A-D16RK1 FC5A-D16RS1	FC5A-D32K3 FC5A-D32S3
	FC4A-D20RK1 FC4A-D20RS1	—	FC4A-D40K3 FC4A-D40S3
Output Points	2 (2/1 common)	2 (2/1 common)	16 (8/1 common)
Output	Transistor Sink	FC5A-D16K1/D32K3 FC4A-D20K3/D20RK1/D40K3	
	Transistor Source	FC5A-D16RS1/D32S3 FC4A-D20S3/D20RS1/D40S3	
Load Voltage	24V DC		
Operating Load Voltage Range	20.4 to 28.8V DC		
Load Current	0.3A per output point		
Maximum Load Current	1A per common		
Voltage Drop (ON Voltage)	1V maximum (voltage between COM and output terminals when output is on)		
Inrush Current	1A		
Leakage Current	0.1mA maximum		
Clamping Voltage	39V±1V		
Maximum Lamp Load	8W		
Inductive Load	L/R = 10ms (28.8V DC, 1 Hz)		
External Current Draw	Sink output: 100mA maximum, 24V DC (power voltage at the +V terminal) Source output: 100mA maximum, 24V DC (power voltage at the -V terminal)		
Isolation	Between output terminal and internal circuit: Photocoupler isolated Between output terminals: Not isolated		
Connector on Mother Board	FL26A2MA (Oki Electric Cable)	MC1.5/16-G-3.81BK (Phoenix Contact)	FL26A2MA (Oki Electric Cable)
Connector Insertion/Removal Durability	100 times minimum		
Output Delay	Turn ON Time	FC5A Q0 to Q2: 5µs max. Q3 to Q7, Q10 to Q17: 300µs max. FC4A Q0, Q1: 5µs max. Q2 to Q7, Q10 to Q17: 300µs max.	
	Turn OFF Time	FC5A Q0 to Q2: 5µs max. Q3 to Q7, Q10 to Q17: 300µs max. FC4A Q0, Q1: 5µs max. Q2 to Q7, Q10 to Q17: 300µs max.	

Relay Output

Part Number	FC5A-C10R2 FC5A-C10R2C	FC5A-C16R2 FC5A-C16R2C	FC5A-C24R2 FC5A-C24R2C	FC5A-D16RK1 FC5A-D16RS1	
	FC4A-C10R2 FC4A-C10R2C	FC4A-C16R2 FC4A-C16R2C	FC4A-C24R2 FC4A-C24R2C	FC4A-D20RK1 FC4A-D20RS1	
No. of Outputs	4	7	10	8	
Output Points per Common Line	COM0	3	4	4	2 (Transistor output)
	COM1	1	2	4	3
	COM2	—	1	1	2
	COM3	—	—	1	1
Output	1 NO form A				
Maximum Load Current	2A per point 8A per common line				
Minimum Switching Load	0.1mA/0.1V DC (reference value)				
Initial Contact Resistance	30 mΩ maximum				
Electrical Life	100,000 operations minimum (rated load 1,800 operations/hour)				
Mechanical Life	20,000,000 operations minimum (no load 18,000 operations/hour)				
Rated Load	240V AC/2A (resistive load, inductive load cos φ = 0.4) 30V DC/2A (resistive load, inductive load L/R = 7ms)				
Dielectric Strength	Between output and terminals: 1,500V AC, 1 minute Between output terminal and internal circuit: 1,500V AC, 1 minute Between output terminals (COMs): 1,500V AC, 1 minute				
Connector on Mother Board	—			*	
Connector Insertion/Removal Durability	—			100 times minimum	



*MC1.5/16-G-3.81BK (Phoenix Contact)

PLCs

Operator Interfaces

Automation Software

Power Supplies

Sensors

Communication & Networking

Dimensions (mm)

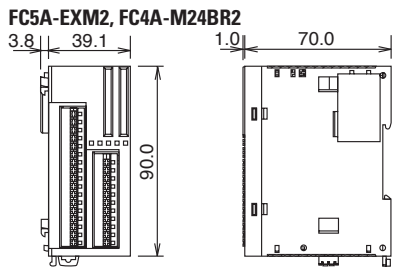
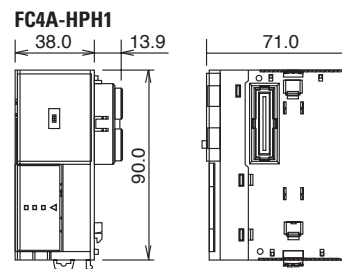
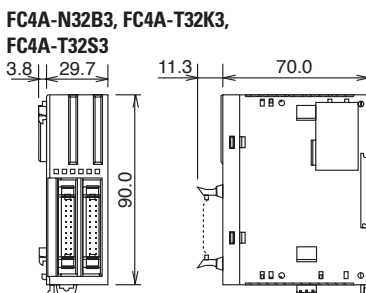
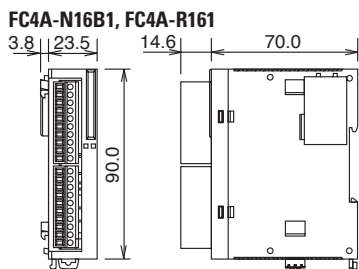
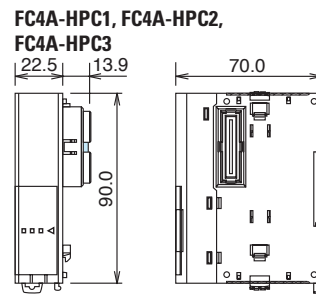
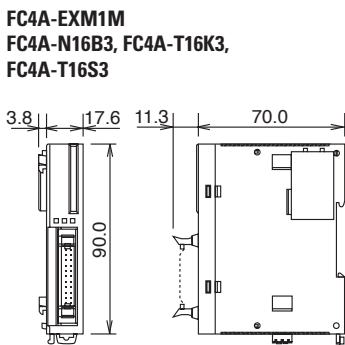
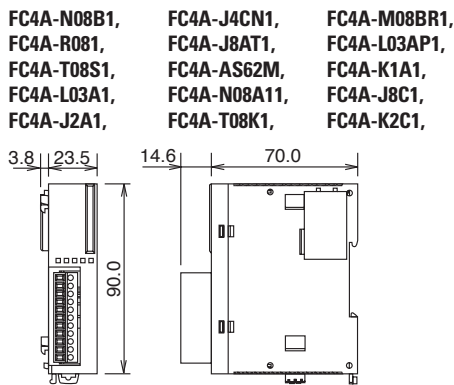
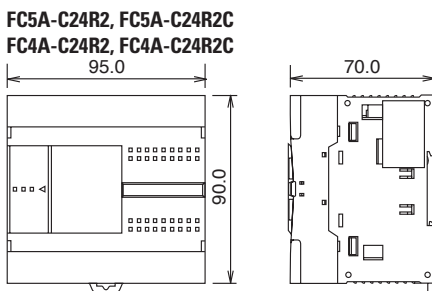
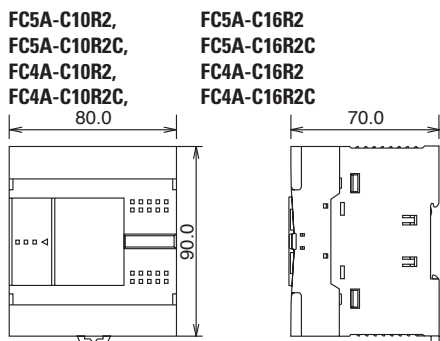
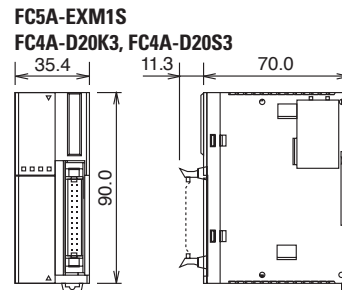
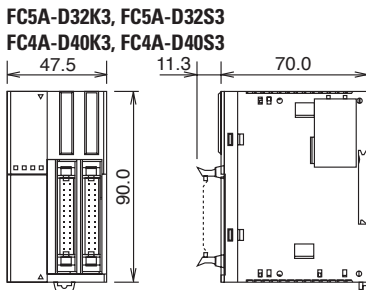
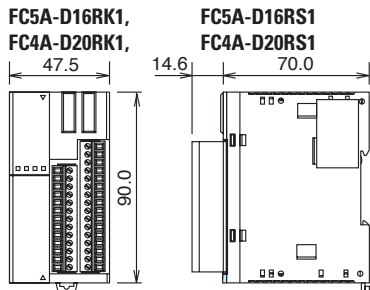

Example

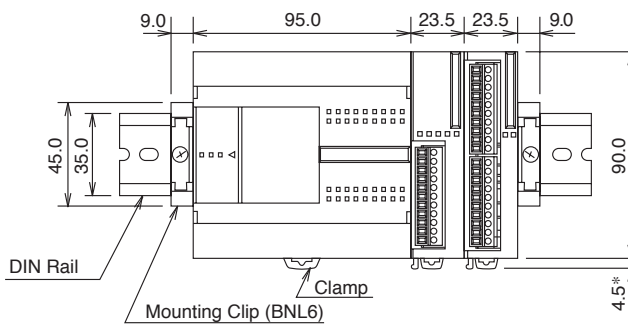

The figure illustrates a system setup consisting of the all-in-one 24-I/O CPU module, an 8-point relay output module, and a 16-point DC input module mounted on a 35-mm-wide-DIN rail using BNL6 mounting clips.

Mounting Hole Layout (mm)

FC5A-C10R2, FC5A-C16R2
 FC5A-C10R2C, FC5A-C16R2C
 FC4A-C10R2, FC4A-C16R2
 FC4A-C10R2C, FC4A-C16R2C

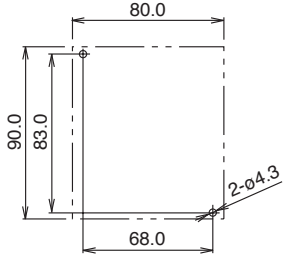

FC4A-N08A11, FC4A-R081
 FC4A-R161, FC4A-T08K1
 FC4A-T08S1, FC4A-M08BR1
 FC4A-L03A1, FC4A-L03AP1
 FC4A-J2A1, FC4A-K1A1
 FC4A-J4CN1, FC4A-T8C1
 FC4A-J8AT1, FC4A-K2C1

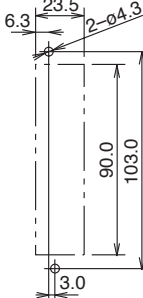

FC5A-EXM2
 FC4A-M24BR2

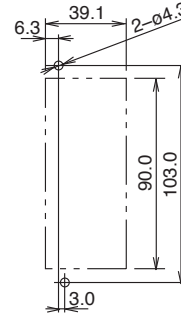

FC5A-EXM1S, FC4A-D20K3
 FC4A-D20S3

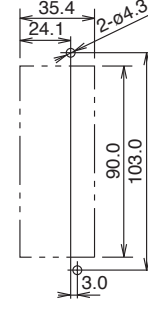

FC5A-C24R2, FC4A-C24R2C
 FC4A-C24R2, FC4A-C24R2C

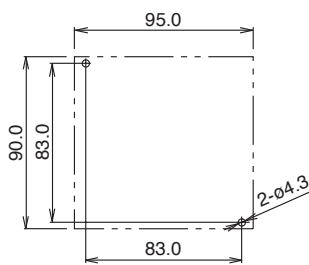

FC5A-EXM1M
 FC4A-N16B3, FC4A-T16K3,
 FC4A-T16S3

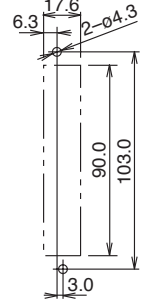

FC4A-HPC1 FC4A-HPC2
 FC4A-HPC3

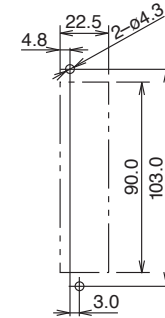

FC4A-N32B3, FC4A-T32K3,
 FC4A-T32S3

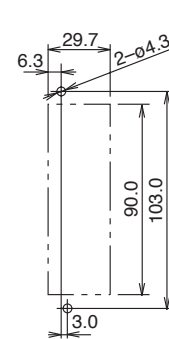

FC5A-D16RK1
 FC5A-D16RS1
 FC5A-D32K3
 FC5A-D32S3
 FC4A-D20RK1
 FC4A-D20RS1
 FC4A-D40K3
 FC4A-D40S3

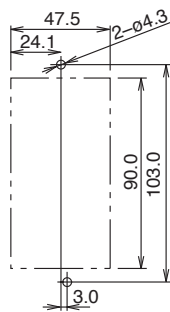

FC4A-HPH1

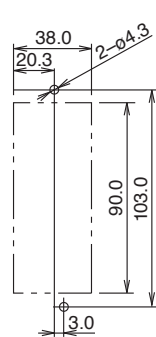

FC4A-HPH1

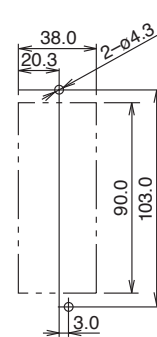

Examples

Mounting hole layout for FC5A-C24R2 or FC4A-C24R2 and four 23.5mm-wide I/O modules

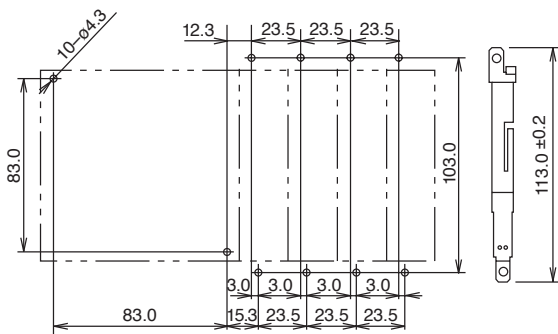

Mounting hole layout from left, FC4A-HPH1, FC4A-D20K3, FC4A-N16B3, FC4A-N32B3, and FC4A-M24BR2 modules

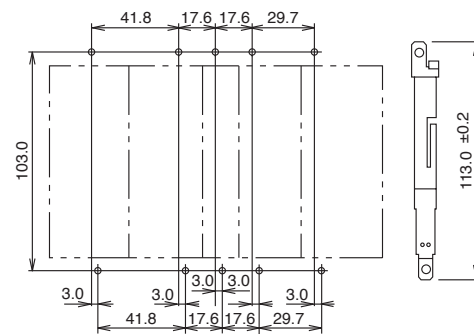

Web Server

General Specifications

Rated Power Voltage	24V DC
Allowable Voltage Range	20.4 to 26.4V DC
Current Draw	70 mA
Allowable Momentary Power Interruption	10 ms maximum
Dielectric Strength	500V AC, 1 minute
Insulation Resistance	10 MΩ minimum (500V DC megger)
Noise Resistance	DC power terminal: 1.0 kV, 50 ns to 1 μs Ethernet cable: 0.5 kV, 50 ns to 1 μs (coupling clamp)
Inrush Current	4A maximum
Operating Temperature	0 to 55°C
Storage Temperature	-40 to +70°C (no freezing)
Relative Humidity	10 to 95% (no condensation)
Pollution Degree	2 (IEC 60664-1)
Corrosion Immunity	Free from corrosive gases
Degree of Protection	IP20 (IEC60529)
Vibration Resistance	When mounted on a DIN rail: 5 to 9 Hz amplitude 3.5 mm 9 to 150 Hz acceleration 9.8 m/s ² (1G) 2 hours in each of 3 axes
Shock Resistance	147 m/s ² (15G), 11 ms duration 3 shocks each in 3 axes
Weight (approx.)	150g

Interface Specifications

Communication	RS232C <=> Ethernet conversion function
Ethernet Specifications	Electrical characteristics: Complies with IEEE802.3 Transmission speed: 10BASE-T/100BASE-TX (Not CE compliant) Communication protocol: IP/ICMP/ARP Ethernet protocol: TCP/SMTP/HTTP/Telnet No. of TCP connections: 1
Serial Interface Specifications	Electrical characteristics: EIA RS232C Transmission speed: 9600 to 115200 bps Synchronization: Asynchronous Communication protocol: Full duplex Transmission control: RTS/CTS, XON/OFF, None
Connection Method	Ethernet interface: RJ45 Serial interface: Mini DIN 8-pin connector Cable Part No.: FC4A-KC3C
Major Functions	Remote maintenance: Uploading, downloading and monitoring using WindLDR via Ethernet Web server: Configure the web server unit using Internet Explorer etc. Reading and writing PLC operands using Java applet. Web file area: 512 KB Compliant browser: Internet Explorer 6.0 or higher, Netscape Navigator 7.2 Ethernet user communication: User communication using Ethernet Message transmission: Registered outgoing message 32 message types, 63 characters maximum per message, 2 email addresses, 64 address characters maximum
Optional	Utility CD: Configuration file, PLC operand monitor sample programs, sample program configuration instructions, instruction manual (English/German/Spanish/Japanese/Chinese)

Connectable Devices

Programmable Controllers	Operator Interface
IDEC FC5A MicroSmart	(RS232C communication with PLC through Ethernet)
IDEC FC4A MicroSmart	IDEC HG2F
IDEC FC3A OpenNet Controller	

Dimensions

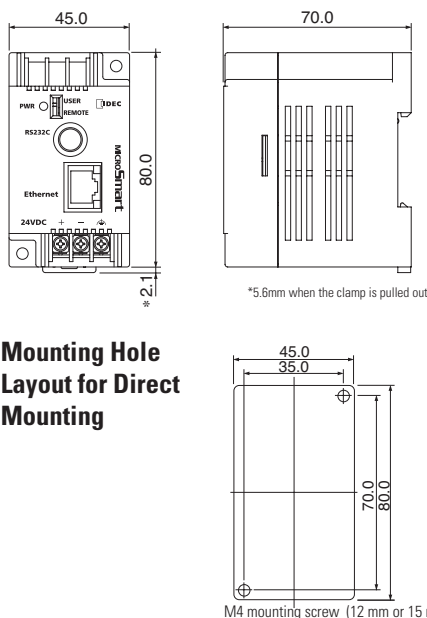

Web Server Cable (FC4A-KC3C, Cable Length: 100 mm)

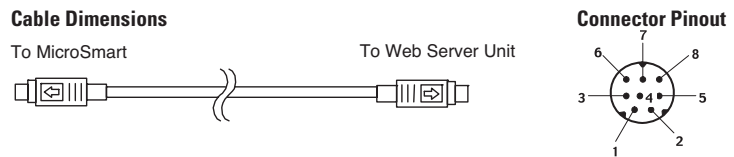

Cable Connection Diagram

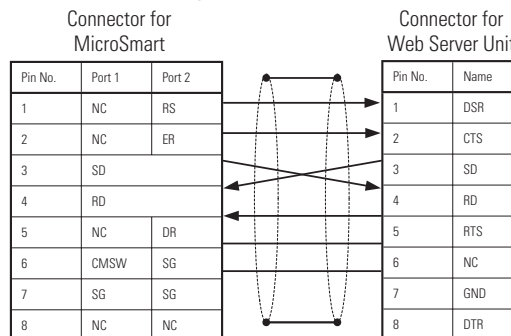

Ethernet is a registered trademark of Xerox Corporation.