

Inductive Sensors

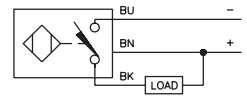
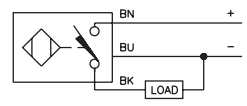
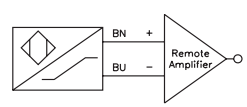
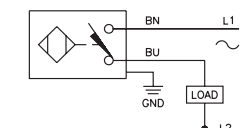

Housing Style	Part Number	ID Number	Features	Sensing Range (mm)	Output
18 mm - Embeddable, Full Threading, Potted-In Cable 	Bi 5-G18K-AN6X	T4671400	<i>Short Barrel</i>	5	3-Wire DC NPN
	Bi 5-G18K-AN7X	T4740593	<i>TTL Compatible</i>	5	
	Bi 5-G18K-AP6X	T4670400		5	3-Wire DC PNP
	Bi 5-EG18-Y0	T1006001		5	2-Wire NAMUR
	Bi 5-G18-Y0	T1006000		5	
	Bi 5-G18-Y0X	T4015000		5	
18 mm - Embeddable, Full Threading, Potted-In Cable 	Bi 5-EG18-AN6X	T4611101		5	3-Wire DC NPN
	Bi 5-G18-AN6X	T4641500		5	
	Bi 5-G18-AN7X	T4740500	<i>TTL Compatible</i>	5	
	Bi 8-G18-AN6X	T4616101	<i>Ext. Range</i>	8	
	Bi 5-EG18-AP6X	T4611001		5	3-Wire DC PNP
	Bi 5-G18-AP6X	T4641400		5	
Bi 8-G18-AP6X	T4615088		8		
18 mm - Embeddable, Full Threading, Potted-In Cable 	Bi 5-G18-ADZ30X2	T4212000		5	2-Wire AC/DC Short-Circuit Protected
	Bi 8-G18-ADZ30X2	T4209320	<i>Extended Range</i>	8	
	Bi 5-EG18-AZ3X	T4611190		5	2-Wire AC/DC
	Bi 5-G18-AZ3X	T4330400		5	
	Bi 5-G18-AZ3X2	T1374195		5	

Output	Switching Freq. (Hz)	Operating Current (mA) VAC/VDC	Operating Temp. (°C)	Protection	Housing	Face	End Cap	Power LED	Output LED	Cable Length/ Cable /Mat.	Wiring Diagram #	Wiring Diagrams
10-30 VDC	1000	≤200	-25 to +70	IP 67	CPB	PA 12	EPTR	N/A	YE	2M/PVC	1	Diagram 1 
	1000	≤200	-25 to +70	IP 67	CPB	PA 12	EPTR	N/A	YE	2M/PVC	1	
10-30 VDC	1000	≤200	-25 to +70	IP 67	CPB	PA 12	EPTR	N/A	YE	2M/PVC	2	Diagram 2 
5-30 VDC	1000	Remote	-25 to +70	IP 67	SS	PA 12	EPTR	N/A	N/A	2M/PVC	3	
	1000	Remote	-25 to +70	IP 67	CPB	PA 12	EPTR	N/A	N/A	2M/PVC	3	
	1000	Remote	-25 to +70	IP 67	CPB	PA 12	EPTR	N/A	YE	2M/PVC	3	
10-30 VDC	1000	≤200	-25 to +70	IP 67	SS	PA 12	EPTR	N/A	YE	2M/PVC	1	Diagram 3 
	1000	≤200	-25 to +70	IP 67	CPB	PA 12	EPTR	N/A	YE	2M/PVC	1	
	1000	≤150	-25 to +70	IP 67	CPB	PA 12	EPTR	N/A	YE	2M/PVC	1	
	500	≤200	-25 to +70	IP 67	SS	PA 12	EPTR	N/A	YE	2M/PVC	1	
10-30 VDC	1000	≤200	-25 to +70	IP 67	SS	PA 12	EPTR	N/A	YE	2M/PVC	2	Diagram 4 
	1000	≤200	-25 to +70	IP 67	CPB	PA 12	EPTR	N/A	YE	2M/PVC	2	
	500	≤200	-25 to +70	IP 67	SS	PA 12	EPTR	N/A	YE	2M/PVC	2	
20-250 VAC 10-300 VDC	20	≤400/300	-25 to +70	IP 67	CPB	PA 12	EPTR	GN	RD	2M/PVC	4	
	20	≤400/300	-25 to +70	IP 67	SS	PA 12	EPTR	GN	RD	2M/PVC	4	
20-250 VAC 10-300 VDC	20	≤400/300	-25 to +70	IP 67	SS	PA 12	EPTR	N/A	RD	2M/PVC	4	
	20	≤400/300	-25 to +70	IP 67	CPB	PA 12	EPTR	N/A	RD	2M/PVC	4	
	20	≤400/300	-25 to +70	IP 67	CPB	PA 12	EPTR	N/A	RD	2M/PVC	4	

WIRING DIAGRAMS

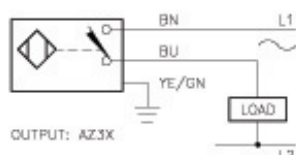

WARNING: NO SHORT-CIRCUIT PROTECTION
ALWAYS WIRE A LOAD IN SERIES WITH THE SENSOR.

LOCKNUT LN-M18

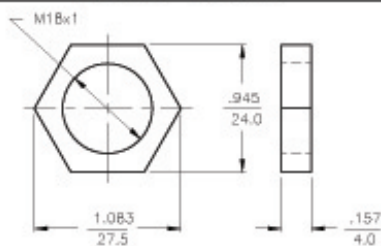

SPECIFICATIONS

OPERATING VOLTAGE	20-250 VAC/DC
LINE FREQUENCY	40-60 Hz
DIFFERENTIAL TRAVEL (HYSTERESIS)	3-15% (5% TYPICAL)
VOLTAGE DROP ACROSS CONDUCTING SENSOR	≤ 7.0 V at 500 mA
OUTPUT FUNCTION -AZ	NORMALLY OPEN 2-WIRE AC SELF-CONTAINED
SHORT-CIRCUIT PROTECTED	NO
CONTINUOUS LOAD CURRENT	≤ 500 mA
OFF-STATE (LEAKAGE) CURRENT	≤ 1.7 mA
MINIMUM LOAD CURRENT	≥ 5.0 mA
INRUSH CURRENT	≤ 8.0 A (≤ 10 ms/5 Hz)
TIME DELAY BEFORE AVAILABILITY	≤ 25 ms
POWER-ON EFFECT PROTECTION	INCORPORATED
PROTECTION AGAINST TRANSIENTS	5 kV, 10 ms, 10 kΩ
OPERATING TEMPERATURE	-25°C to +70°C (-13°F to +158°F)
ENCLOSURE	MEETS NEMA 1, 3, 4, 6, 13 AND IEC IP67
SHOCK	30 g, 11 ms
VIBRATION	55 Hz, 1 mm AMPITUDE (IN ALL 3 PLANES)
LED FUNCTION	RED: OUTPUT ENERGIZED
SENSING RANGE	5 mm = .197" (NOMINAL)
SWITCHING FREQUENCY	20 Hz
REPEATABILITY	≤ 2% OF RATED OPERATING DISTANCE
EMBEDDABLE (SHIELDED)	YES

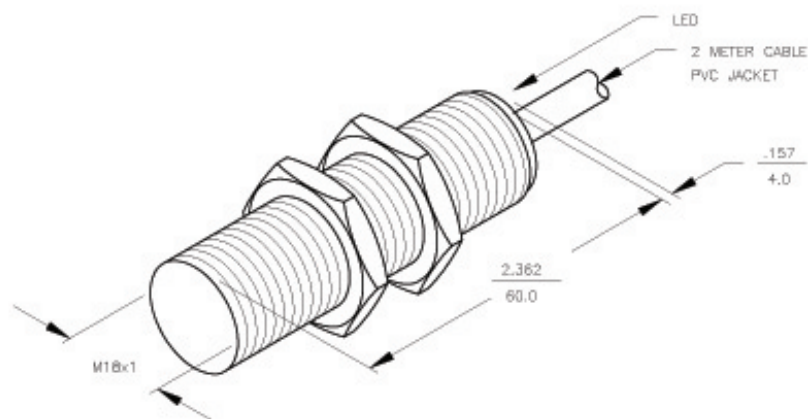

RELATED DOCUMENTS 1. 2. 3. 4.	3RD ANGLE PROJECTION 	THIS DRAWING IS PROPERTY OF TURCK INC. USE OF THIS DOCUMENT WITHOUT WRITTEN PERMISSION IS PROHIBITED.		TURCK INC High Technology Sensors and Automation Controls	
MATERIAL BRASS BARREL	TOLERANCES UNLESS OTHERWISE SPECIFIED .X ± 0.02 .XX ± 0.01 .XXX ± 0.005 ANGLES ± 1° ALL MILLIMETER DIMENSIONS ARE REFERENCED ONLY	DRAWN GMB	DATE 4/22/88	DESCRIPTION BIS-G18-AZ3X 60MM	
FINISH COPPER, NICKEL, CHROME PLATING		UNIT OF MEASUREMENT INCH [MILLIMETER]		IDENTIFICATION NO. T4330400	REV E
E UPDATE OPERATING VOLTAGE, SEE ECO	RWC	08/08/07	18320	FILE: T4330400	
REV DESCRIPTION	BY	DATE	EDD NO.	SHEET 1 OF 1	