

32/35 SERIES

- PRESSFIT INDICATOR LIGHTS
- NEON, LED & INCANDESCENT
- 2 TO 600 DESIGN VOLTS
- 6" WIRE LEADS & 3/16" TAB TERMINALS
- VARIETY OF LENS COLORS
- UL AND CSA LISTED • UL FILE E20356
- CSA FILE LR15284-5

Overview

The 32/35 Series Indicators feature a wide variety of lenses, colors, voltage & bezel variations. Indicators quickly pressfit into a 0.500" to 0.510" mounting hole with recommended panel thickness range of 0.020" min. to 0.090" max. A speednut, part number **8700071674**, and Adapters for 0.514" to 0.519" are available.

Specifications

Housing: white nylon. A black housing is available.

Bezel: nickel plated brass. A black anodized bezel is available.

Lens: polycarbonate.

Incandescent AC or DC voltage options: 6, 14 and 28 volts.

Neon AC or DC voltage options: 125, 250 and 600 volts. **Note:** high brightness green and blue neon lamps supplied in green and blue neon applications.

LED DC voltage options: 2, 6, 12, 24 volts.

LED AC voltage options: 125 volts.

Note: 125 volts AC units contain a bi-polar LED.

Two 6" wire leads: #20 AWG, black, bare copper, PVC insulated, UL/CSA rated 105°C, 600 V, UL style 1015, stripped 1/2". For DC LED units, wire leads are color-coded red and black; the red wire lead denotes the anode (+) while a black wire lead identifies the cathode (-). For AC LED units, wire leads are white. Custom wire lengths, stripping, termination and wire types are available.

Terminals:

3/16" tabs: brass, (0.187" length x 0.020" thick). For LED units, a tin plated terminal denotes the anode (+). 1/4" or 1/8" brass tab terminals are available.

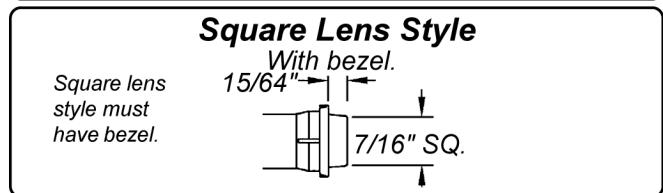
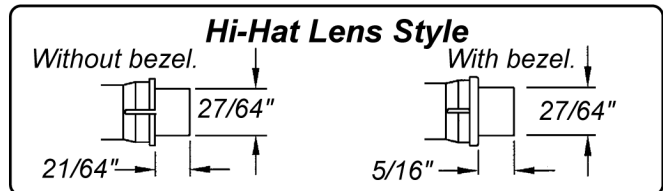
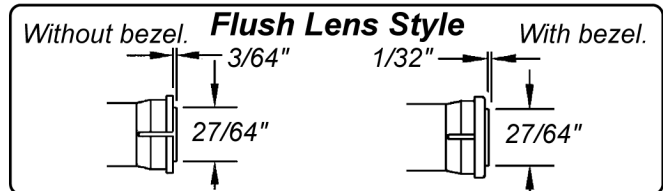
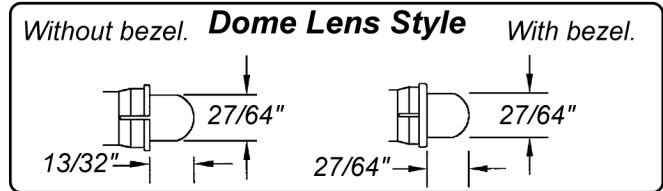
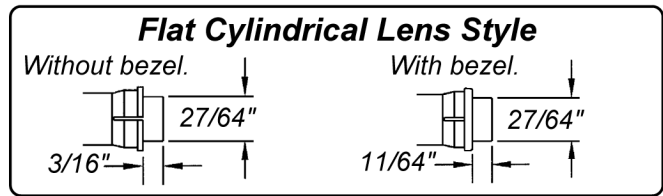
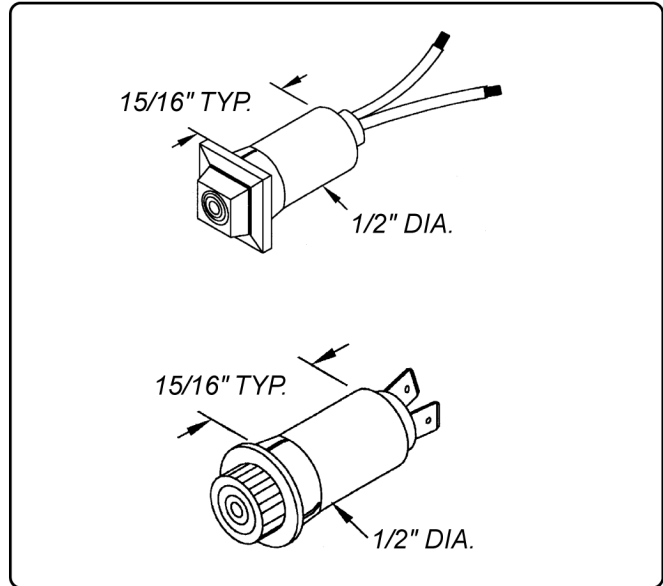

**32/35 Series
Dome Lens
Without Bezel
Neon or
Incandescent**

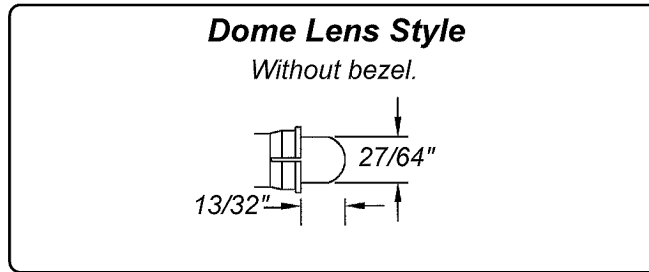

**6" Wire Leads or
3/16" Tab Terminals
White Housing
6 to 250 Design Volts
PressFit Mounting**

Part Number 6" Wire Leads	Part Number 3/16" Tab Terminals	Lens Color	Lamp Type	Design Volts	Design Watts or Amps	Life (hrs)
32-2211	32-2211T	Red	Neon	125	1/3W	25,000
35-2211	35-2211T	Red	Neon	250	1/3W	25,000
32G1-2211	32G1-2211T	Red	Incandescent	6	.20A	5,000
32G3-2211	32G3-2211T	Red	Incandescent	14	.10A	10,000
32G18-2211	32G18-2211T	Red	Incandescent	28	.04A	7,000
32-2212	32-2212T	Green	Neon	125	1/3W	25,000
35-2212	35-2212T	Green	Neon	250	1/3W	25,000
32G1-2212	32G1-2212T	Green	Incandescent	6	.20A	5,000
32G3-2212	32G3-2212T	Green	Incandescent	14	.10A	10,000
32G18-2212	32G18-2212T	Green	Incandescent	28	.04A	7,000
32-2213	32-2213T	Amber	Neon	125	1/3W	25,000
35-2213	35-2213T	Amber	Neon	250	1/3W	25,000
32G1-2213	32G1-2213T	Amber	Incandescent	6	.20A	5,000
32G3-2213	32G3-2213T	Amber	Incandescent	14	.10A	10,000
32G18-2213	32G18-2213T	Amber	Incandescent	28	.04A	7,000
32-2214	32-2214T	Blue	Neon	125	1/3W	25,000
35-2214	35-2214T	Blue	Neon	250	1/3W	25,000
32G1-2214	32G1-2214T	Blue	Incandescent	6	.20A	5,000
32G3-2214	32G3-2214T	Blue	Incandescent	14	.10A	10,000
32G18-2214	32G18-2214T	Blue	Incandescent	28	.04A	7,000
32-2215	32-2215T	White	Neon	125	1/3W	25,000
35-2215	35-2215T	White	Neon	250	1/3W	25,000
32G1-2215	32G1-2215T	White	Incandescent	6	.20A	5,000
32G3-2215	32G3-2215T	White	Incandescent	14	.10A	10,000
32G18-2215	32G18-2215T	White	Incandescent	28	.04A	7,000
32-2217	32-2217T	Clear	Neon	125	1/3W	25,000
35-2217	35-2217T	Clear	Neon	250	1/3W	25,000
32G1-2217	32G1-2217T	Clear	Incandescent	6	.20A	5,000
32G3-2217	32G3-2217T	Clear	Incandescent	14	.10A	10,000
32G18-2217	32G18-2217T	Clear	Incandescent	28	.04A	7,000