

3408

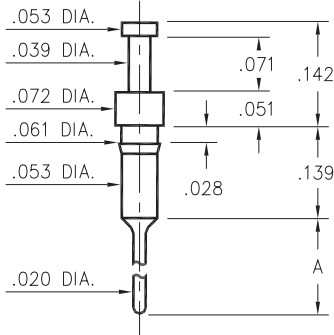

Basic Part Number	Pin Length A
3408-1	.121
3408-2	.181

3408-X-00-XX-00-00-03-0
Press-fit in .057 mounting hole

0270/0282

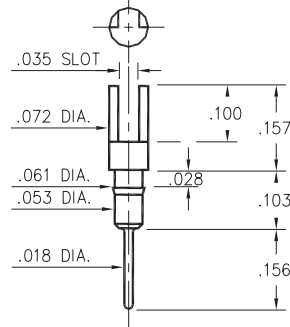

Basic Part Number	Pin Material
0270-0	Ph Br 544 (B2)
0282-0	Brass 360

02XX-0-01-XX-00-00-03-0
Press-fit in .057 mounting hole

0700

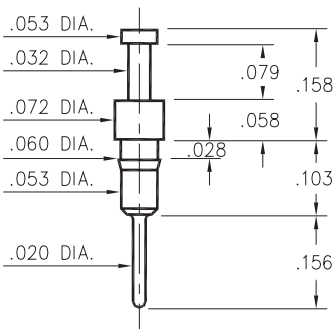

0700-0-00-XX-00-00-03-0
Press-fit in .057 mounting hole

8006

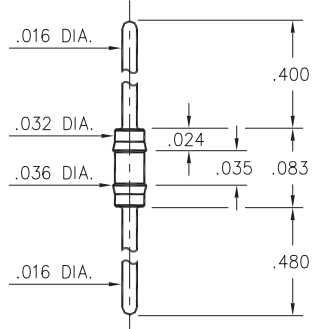

8006-0-00-XX-00-00-03-0
Press-fit in .034 mounting hole

0265

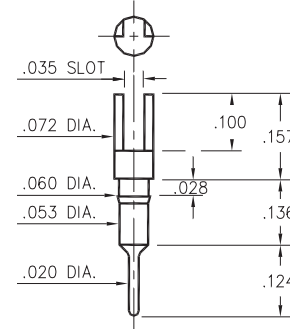

0265-0-01-XX-00-00-03-0
Press-fit in .057 mounting hole

0275

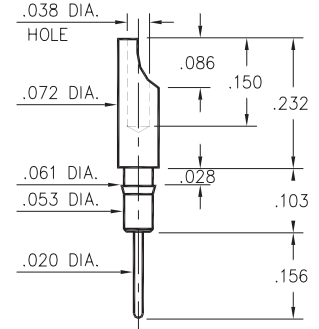

0275-0-01-XX-00-00-03-0
Press-fit in .057 mounting hole
Pin material is Ph. Br. 544 (B2)

0272

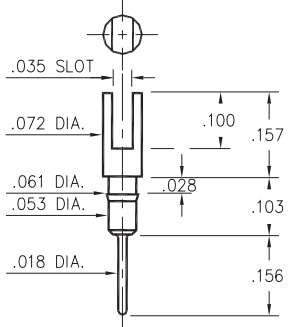

0272-0-01-XX-00-00-03-0
Press-fit in .057 mounting hole

8000

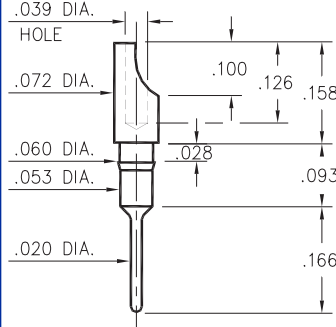

8000-0-01-XX-00-00-03-0
Press-fit in .057 mounting hole

3603

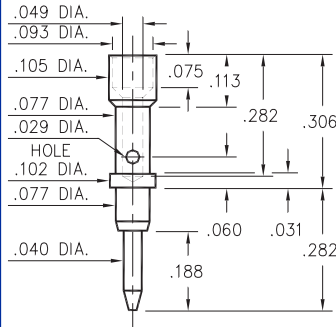

3603-0-07-XX-00-00-08-0
Annealed
#20 Crimp barrel

9976

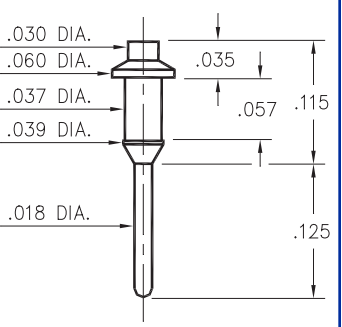

9976-0-00-XX-00-00-03-0
Press-fit in .038 mounting hole

SPECIFICATIONS

PIN MATERIAL:
Brass Alloy 360, 1/2 Hard
(Except where noted)

DIMENSION IN INCHES
TOLERANCES ON:
LENGTHS: ±.005
DIAMETERS: ±.002
ANGLES: ± 2°

ORDER CODE: XXXX - X - 0X - XX - 00 - 00 - 0X - 0

BASIC PART #

SPECIFY PIN FINISH:

- 01 200µ" TIN/LEAD OVER NICKEL
- 80 200µ" TIN OVER NICKEL
- 15 10µ" GOLD OVER NICKEL
- 21 20µ" GOLD OVER NICKEL
- 34 50µ" GOLD OVER NICKEL

