

LS-Titan Miniature DIN Switches



### Contents

Description	Page
LS-Titan Miniature DIN Switches	
Product Identification	2
Product Selection	3
LS-Titan Plastic Safety Switches	3
LS-Titan Plastic Electronic Safety Position Switches	6
LS-Titan Metal Safety Switches	10
Understanding LS-Titan Electronic Safety Position Switches	12
Accessories	13
Technical Data and Specifications	14
Contact Travel Diagrams	17
Dimensions	20

## LS-Titan Miniature DIN Switches

### Product Description

Eaton's LS-Titan® limit switch line is a complete offering of safety position switches designed for worldwide application. Economical insulated plastic or rugged metal enclosures and modular, plug-in operating heads and bodies make LS-Titan a flexible switching solution.

A highlight of the LS-Titan switch line is the world's first electronic position switch (LSE models). These switches feature freely programmable operating points that can be set individually at any time. Additional LSE models provide analog outputs proportional to the actuator position.

LS-Titan switches are suitable for use in safety applications designed to protect persons or processes.

### Features

- Modular, plug-in system (head and body components)
- Positive opening NC contacts for safety applications
- Wide variety of economical plastic and rugged metal versions available
- Operating heads can be rotated 90 degrees to suit specific direction of operation
- Unique electronic safety position switches (LSE models) provide analog (0–10 Vdc or 4–20 mA) outputs proportional to the actuator position and allow for easy configuration of a custom trip point
- Can be ordered as separate components (head and body) or as completely assembled switches
- Screw and Cage Clamp® (standard on LSE models and optionally available on mechanical models) connections provide larger wiring areas for easier installation
- Approved for worldwide application

### Standards and Certifications

- Safety function by positive opening contacts per IEC/EN 60947-5-1 up to Category 4 per EN 954-1
- TÜV-Rheinland Certified for Functional-Safety (LSE models)
- CSA® certified
- UL® listed
- CE
- CCC



Listed

**Note:** Cage Clamp is a registered trademark of Wago Kontakttechnik, 32423 Minden, Germany.

# 2.3

## Limit Switches

### LS-Titan Miniature DIN Switches

#### Product Identification

2

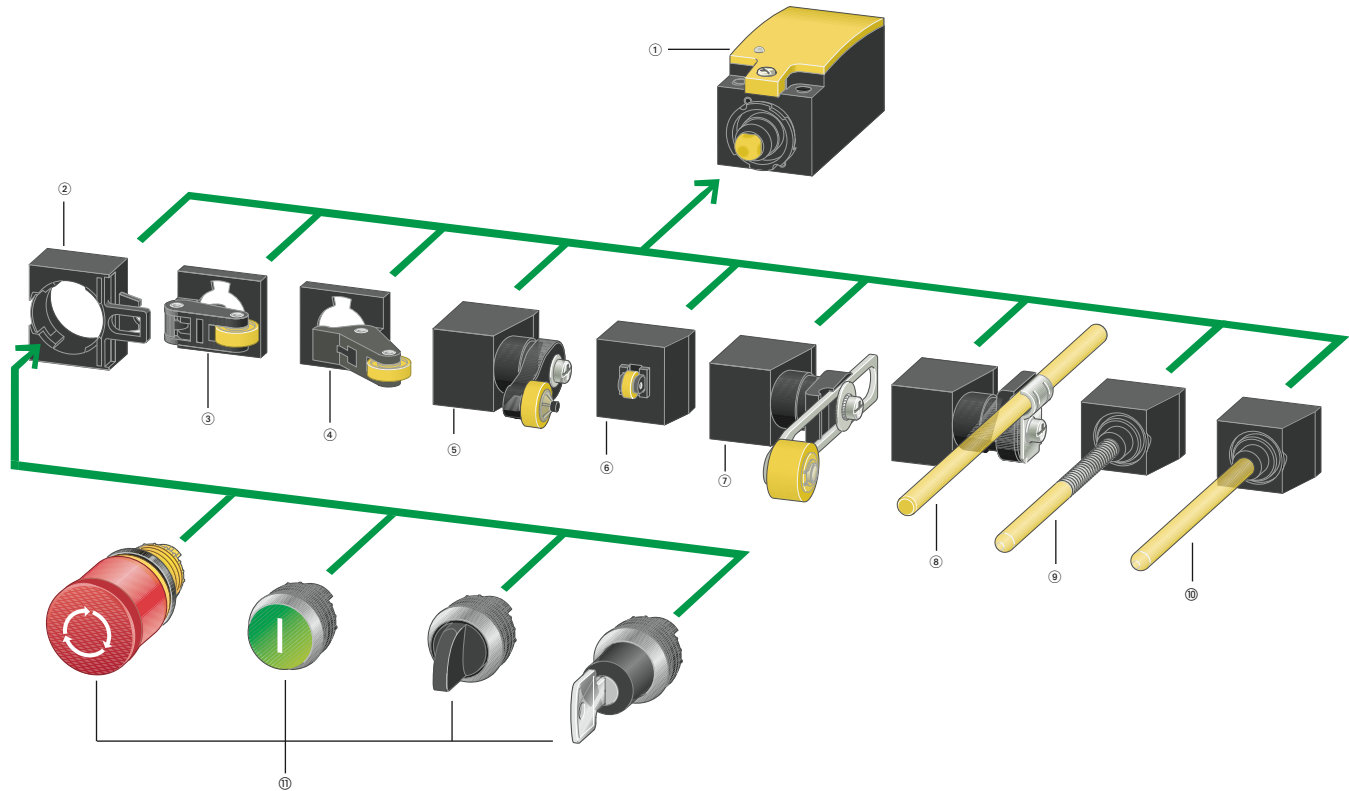

#### Notes

① **Basic device** (see **Pages 3–11**)  
 According to EN 50047  
 With screw-on cover  
 Contacts: 1NO/1NC, 2NO, 2NC  
 Cage Clamp, screw terminal  
 As snap-action or standard-action switch  
 As electronic snap-action switch  
 (individually adjustable)  
 As 4–20 mA analog signal encoder  
 As 0–10 Vdc analog signal encoder

② **Fixing adapter** (see M22 catalog  
 CA04716001E, Page 60, or  
[www.eaton.com/m22](http://www.eaton.com/m22))  
 Allows mounting of M22 pushbuttons

③ **Roller lever** (see **Pages 3 and 6**)  
 For one-sided operation with higher  
 operating speed

④ **Angled roller lever**  
 (see **Pages 3, 6 and 10**)  
 For actuation along the unit axis

⑤ **Rotary lever** (see **Pages 3, 7 and 10**)  
 For actuation from the side, for  
 pendulum movements

⑥ **Roller plunger** (see **Pages 3, 6 and 10**)  
 For actuation from the side with low  
 actuating force

⑦ **Adjustable roller lever**  
 (see **Pages 4, 7, 8 and 10**)  
 For length adjustment as required

⑧ **Actuating rod** (see **Pages 5, 9 and 11**)  
 On conveyor belts for lightweight goods

⑨ **Spring-rod** (see **Pages 5, 9 and 11**)  
 For flexible actuation from all sides

⑩ **Actuating rod** (see **Pages 5, 9 and 11**)  
 Withdrawable mechanism from front

⑪ Pushbuttons from the M22 family; see  
 M22 catalog (CA04716001E) or  
[www.eaton.com/m22](http://www.eaton.com/m22)

**Operating heads can be rotated  
 by 90 degrees.**

### Product Selection

#### LS-Titan Plastic Safety Switches

##### Plastic Safety Switch Bodies



##### Assembled Switch



### Plastic Safety Switches

#### Switch Body Catalog Number

#### Output Function

#### Terminal Connection

#### Contact Sequence

#### Contact Travel

- = contact closed
- = contact open

#### Operating Head Type ②

#### Catalog Numbers Heads Only

#### LS-S02

2NC with Positive Opening Contacts

Screw Terminal ①

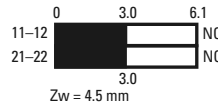

#### LS-S20A

2NO with Slow Make/Break

Screw Terminal ①

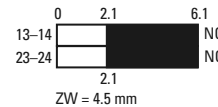

#### LS-S11S

1NO and 1NC with Positive Opening Contact

Screw Terminal ①

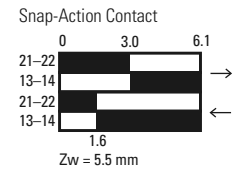

#### Catalog Numbers Assembled Switches

##### Top Push Roller Plunger



LS-XP

LS-S02-P

LS-S20A-P

LS-S11S-P

##### Long Roller Lever



LS-XL

LS-S02-L

LS-S20A-L

LS-S11S-L

##### Short Roller Lever



LS-XLS

LS-S02-LS

LS-S20A-LS

LS-S11S-LS

##### Large Roller Lever



LS-XLB

LS-S02-LB

LS-S20A-LB

LS-S11S-LB

##### Angled Roller



LS-XLA

LS-S02-LA

LS-S20A-LA

LS-S11S-LA

##### Rotary Lever



LS-XRL

LS-S02-RL

LS-S20A-RL

LS-S11S-RL

#### Notes

- ① Cage Clamp versions available. Contact Application Engineering.
- ② For operating head dimensions, see **Page 20**.

# 2.3

## Limit Switches

### LS-Titan Miniature DIN Switches

2

#### Plastic Safety Switch Bodies



#### Assembled Switch



#### Plastic Safety Switches, continued

##### Switch Body Catalog Number

##### Output Function

##### Terminal Connection

##### Contact Sequence

##### Contact Travel

- = contact closed
- = contact open

##### Operating Head Type ②

##### Catalog Numbers Heads Only

##### LS-S02

2NC with Positive Opening Contacts

Screw Terminal ①

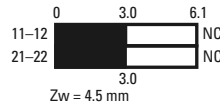

##### LS-S20A

2NO with Slow Make/Break

Screw Terminal ①

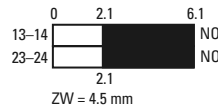

##### LS-S11S

1NO and 1NC with Positive Opening Contact

Screw Terminal ①



##### Snap-Action Contact

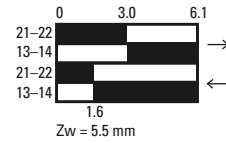

##### Catalog Numbers Assembled Switches

#### Adjustable Roller Lever (with 18 mm Roller)



##### LS-XRLA

##### LS-S02-RLA

##### LS-S20A-RLA

##### LS-S11S-RLA

#### Adjustable Roller Lever (with 30 mm Roller)



##### LS-XRLA30

##### LS-S02-RLA30

##### LS-S20A-RLA30

##### LS-S11S-RLA30

#### Adjustable Roller Lever (with 40 mm Roller)



##### LS-XRLA40

##### LS-S02-RLA40

##### LS-S20A-RLA40

##### LS-S11S-RLA40

#### Adjustable Roller Lever (with 40 mm Rubber Roller)



##### LS-XRLA40R

##### LS-S02-RLA40R

##### LS-S20A-RLA40R

##### LS-S11S-RLA40R

#### Notes

- ① Cage Clamp versions available. Contact Application Engineering.
- ② For operating head dimensions, see **Page 20**.

**Plastic Safety Switch Bodies**



**Assembled Switch**



**Plastic Safety Switches, continued**

**Switch Body Catalog Number**

**Output Function**

**Terminal Connection**

**Contact Sequence**

**Contact Travel**

- = contact closed
- = contact open

**Operating Head Type** ②

**Catalog Numbers  
Heads Only**

**LS-S02**

2NC with Positive Opening Contacts

Screw Terminal ①

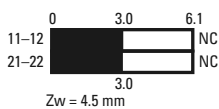

**LS-S20A**

2NO with Slow Make/Break

Screw Terminal ①

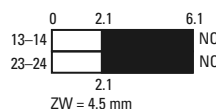

**LS-S11S**

1NO and 1NC with Positive Opening Contact

Screw Terminal ①



**Snap-Action Contact**

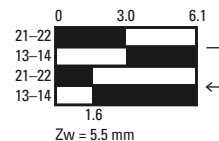

**Catalog Numbers  
Assembled Switches**

**Plastic Rod Lever**



LS-XRR

LS-S02-RR

LS-S20A-RR

LS-S11S-RR

**Metal Rod**



LS-XRRM

LS-S02-RRM

LS-S20A-RRM

LS-S11S-RRM

**Spring Rod (Wobble)** ③



LS-XS

LS-S02-S

LS-S20A-S

LS-S11S-S

**Actuating Rod**



LS-XOR

LS-S02-OR

LS-S20A-OR

LS-S11S-OR

**Notes**

- ① Cage Clamp versions available. Contact Application Engineering.
- ② For operating head dimensions, see **Page 20**.
- ③ Not to be used as a safety position switch. Use only in conjunction with snap-action contact.

# 2.3

## Limit Switches

### LS-Titan Miniature DIN Switches

#### LS-Titan Plastic Electronic Safety Position Switches

#### 2 Plastic Electronic Safety Position Switch Bodies



Assembled Switch



Top Push Roller Plunger



Long Roller Lever



Short Roller Lever



Large Roller Lever



Angled Roller



#### Plastic Electronic Safety Position Switches

##### Switch Body

##### Catalog Number

LSE-11

LSE-02

LSE-AI

LSE-AU

##### Output Function

1NO and 1 NC

2NC

Analog 4–20 mA

Analog 0–10V

##### Terminal Connections

Cage Clamp ①

Cage Clamp ①

Cage Clamp ①

Cage Clamp ①

##### Safety Functions and Approvals

These models may be used in safety-oriented circuits. Visual status LED indication is comparable to positive opening contacts. Certified by TÜV as a "Functional-Safety" device. Suitable for protection of people or processes.

Additional diagnostic output that registers a 0V signal in the event of a fault. Self-test function continuously tests both outputs for overloads, short circuits to 0V and short circuits to +U<sub>e</sub>. Certified by TÜV to EN 954-1, Category 3 or 4. Suitable for protection of people or processes.



##### Contact Sequence

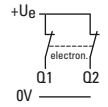
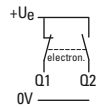

Analog 4–20 mA

Analog 0–10V

##### Contact Travel

■ = contact closed

□ = contact open

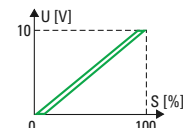
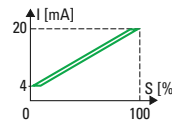
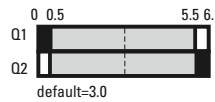
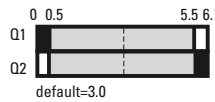

##### Operating Head Type ②

##### Catalog Numbers Heads Only

##### Catalog Numbers Assembled Switches

	LS-XP	LSE-11-P	LSE-02-P	LSE-AI-P	LSE-AU-P
Top Push Roller Plunger					
Long Roller Lever	LS-XL	LSE-11-L	LSE-02-L	LSE-AI-L	LSE-AU-L
Short Roller Lever	LS-XLS	LSE-11-LS	LSE-02-LS	LSE-AI-LS	LSE-AU-LS
Large Roller Lever	LS-XLB	LSE-11-LB	LSE-02-LB	LSE-AI-LB	LSE-AU-LB
Angled Roller	LS-XLA	LSE-11-LA	LSE-02-LA	LSE-AI-LA	LSE-AU-LA

##### Notes

① A compatible Cage Clamp tool is available as an accessory on **Page 13**.

② For operating head dimensions, see **Page 20**.

### Plastic Electronic Safety Position Switches, continued

#### Plastic Electronic Safety Position Switch Bodies



#### Assembled Switch



#### Switch Body

#### Catalog Number

**LSE-11**

**LSE-02**

**LSE-AI**

**LSE-AU**

#### Output Function

1NO and 1NC

2NC

Analog 4–20 mA

Analog 0–10V

#### Terminal Connections

Cage Clamp ①

Cage Clamp ①

Cage Clamp ①

Cage Clamp ①

#### Safety Functions and Approvals

These models may be used in safety-oriented circuits. Visual status LED indication is comparable to positive opening contacts. Certified by TÜV as a "Functional-Safety" device. Suitable for protection of people or processes.

Additional diagnostic output that registers a 0V signal in the event of a fault. Self-test function continuously tests both outputs for overloads, short circuits to 0V and short circuits to +U<sub>e</sub>. Certified by TÜV to EN 954-1, Category 3 or 4. Suitable for protection of people or processes.



#### Contact Sequence

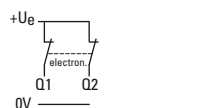
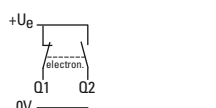

Analog 4–20 mA

Analog 0–10V

#### Contact Travel

■ = contact closed

□ = contact open

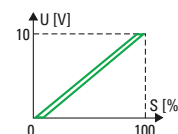
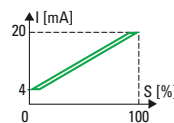
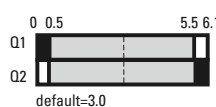
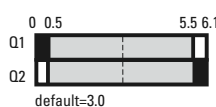

#### Operating Head Type ②

#### Catalog Numbers Heads Only

#### Catalog Numbers Assembled Switches

#### Rotary Lever



**LS-XRL**

**LSE-11-RL**

**LSE-02-RL**

**LSE-AI-RL**

**LSE-AU-RL**

#### Adjustable Roller Lever (with 18 mm Roller)



**LS-XRLA**

**LSE-11-RLA**

**LSE-02-RLA**

**LSE-AI-RLA**

**LSE-AU-RLA**

#### Adjustable Roller Lever (With 30 mm Roller)



**LS-XRLA30**

**LSE-11-RLA30**

**LSE-02-RLA30**

**LSE-AI-RLA30**

**LSE-AU-RLA30**

#### Notes

- ① A compatible Cage Clamp tool is available as an accessory on **Page 13**.
- ② For operating head dimensions, see **Page 20**.

# 2.3

## Limit Switches

### LS-Titan Miniature DIN Switches

2

#### Plastic Electronic Safety Position Switch Bodies



#### Assembled Switch



#### Adjustable Roller Lever (With 40 mm Roller)



#### Adjustable Roller Lever (With 40 mm Roller)



#### Plastic Rod Lever



### Plastic Electronic Safety Position Switches, continued

#### Switch Body

#### Catalog Number

LSE-11

LSE-02

LSE-AI

LSE-AU

#### Output Function

1NO and 1NC

2NC

Analog 4–20 mA

Analog 0–10V

#### Terminal Connections

Cage Clamp ①

Cage Clamp ①

Cage Clamp ①

Cage Clamp ①

#### Safety Functions and Approvals

These models may be used in safety-oriented circuits. Visual status LED indication is comparable to positive opening contacts. Certified by TÜV as a "Functional-Safety" device. Suitable for protection of people or processes.

Additional diagnostic output that registers a 0V signal in the event of a fault. Self-test function continuously tests both outputs for overloads, short circuits to 0V and short circuits to +U<sub>e</sub>. Certified by TÜV to EN 954-1, Category 3 or 4. Suitable for protection of people or processes.



#### Contact Sequence

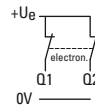
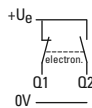

Analog 4–20 mA

Analog 0–10V

#### Contact Travel

■ = contact closed

□ = contact open

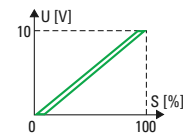
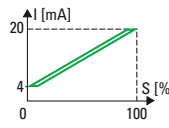
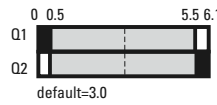
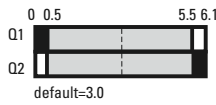

#### Operating Head Type ②

#### Catalog Numbers Heads Only

#### Catalog Numbers Assembled Switches

LS-XRLA40

LSE-11-RLA40

LSE-02-RLA40

LSE-AI-RLA40

LSE-AU-RLA40

LS-XRLA40R

LSE-11-RLA40R

LSE-02-RLA40R

LSE-AI-RLA40R

LSE-AU-RLA40R

LS-XRR

LSE-11-RR

LSE-02-RR

LSE-AI-RR

LSE-AU-RR

#### Notes

① A compatible Cage Clamp tool is available as an accessory on **Page 13**.

② For operating head dimensions, see **Page 20**.



### Plastic Electronic Safety Position Switch Bodies



### Assembled Switch



### Plastic Electronic Safety Position Switches, continued

Switch Body	LSE-11	LSE-02	LSE-AI	LSE-AU
<b>Catalog Number</b>	LSE-11	LSE-02	LSE-AI	LSE-AU
<b>Output Function</b>	1NO and 1NC	2NC	Analog 4–20 mA	Analog 0–10V
<b>Terminal Connections</b>	Cage Clamp <sup>①</sup>	Cage Clamp <sup>①</sup>	Cage Clamp <sup>①</sup>	Cage Clamp <sup>①</sup>
<b>Safety Functions and Approvals</b>	These models may be used in safety-oriented circuits. Visual status LED indication is comparable to positive opening contacts. Certified by TÜV as a “Functional-Safety” device. Suitable for protection of people or processes.		Additional diagnostic output that registers a 0V signal in the event of a fault. Self-test function continuously tests both outputs for overloads, short circuits to 0V and short circuits to +U <sub>e</sub> . Certified by TÜV to EN 954-1, Category 3 or 4. Suitable for protection of people or processes.	



### Contact Sequence

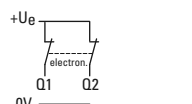
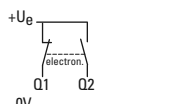

### Contact Travel

- = contact closed
- = contact open

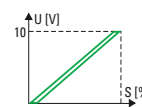
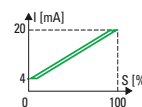
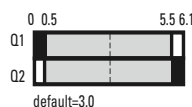
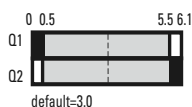

### Operating Head Type <sup>②</sup>

#### Catalog Numbers

Heads Only	Assembled Switches
LS-XRRM	LSE-11-RRM
	LSE-02-RRM
	LSE-AI-RRM
	LSE-AU-RRM

### Metal Rod



### Spring Rod (Wobble) <sup>③</sup>



### Actuating Rod



LS-XRRM	LSE-11-RRM	LSE-02-RRM	LSE-AI-RRM	LSE-AU-RRM
LS-XS	LSE-11-S	LSE-02-S	LSE-AI-S	LSE-AU-S
LS-XOR	LSE-11-OR	LSE-02-OR	LSE-AI-OR	LSE-AU-OR

### Notes

- <sup>①</sup> A compatible Cage Clamp tool is available as an accessory on **Page 13**.
- <sup>②</sup> For operating head dimensions, see **Page 20**.
- <sup>③</sup> Not to be used as a safety position switch. Use only in conjunction with snap-action contact.

# 2.3

## Limit Switches

### LS-Titan Miniature DIN Switches

#### LS-Titan Metal Safety Switches

2

#### Metal Safety Switch Bodies



Assembled Switch



#### Metal Safety Switches

Switch Body Catalog Number

Output Function

Terminal Connection

Contact Sequence

Contact Travel

■ = contact closed

□ = contact open

Operating Head Type ①

Catalog Numbers  
Heads Only

**LSM-02**

2NC with Positive  
Opening Contacts

Cage Clamp

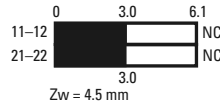

**LSM-20A**

2NO with Slow  
Make/Break

Cage Clamp

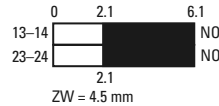

**LSM-11S**

1NO and 1NC with  
Positive Opening Contact

Cage Clamp



Snap-Action Contact

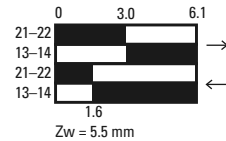

Top Push Roller  
Plunger



**LSM-XP**

**LSM-02-P**

**LSM-20A-P**

**LSM-11S-P**

Long Roller Lever



**LSM-XL**

**LSM-02-L**

**LSM-20A-L**

**LSM-11S-L**

Angled Roller



**LSM-XLA**

**LSM-02-LA**

**LSM-20A-LA**

**LSM-11S-LA**

Rotary Lever



**LSM-XRL**

**LSM-02-RL**

**LSM-20A-RL**

**LSM-11S-RL**

Adjustable Roller Lever



**LSM-XRLA**

**LSM-02-RLA**

**LSM-20A-RLA**

**LSM-11S-RLA**

#### Note

① For operating head dimensions, see **Page 20**.

**Metal Safety Switches, continued**

**Metal Safety Switch Bodies**



Assembled Switch



Plastic Rod Lever



Metal Rod Lever



Spring Rod (Wobble)



**Switch Body Catalog Number**

**Output Function**

**Terminal Connection**

**Contact Sequence**

**Contact Travel**

■ = contact closed  
□ = contact open

**Operating Head Type** ①

**Catalog Numbers  
Heads Only**

**LSM-02**

2NC with Positive Opening Contacts

Cage Clamp

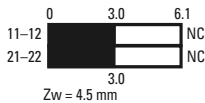

**LSM-20A**

2NO with Slow Make/Break

Cage Clamp

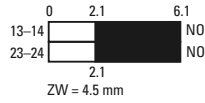

**LSM-11S**

1NO and 1NC with Positive Opening Contact

Cage Clamp



**Snap-Action Contact**

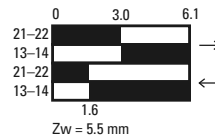

**Catalog Numbers  
Assembled Switches**

<b>LSM-XRR</b>	<b>LSM-02-RR</b>	<b>LSM-20A-RR</b>	<b>LSM-11S-RR</b>
----------------	------------------	-------------------	-------------------

<b>LSM-XRRM</b>	<b>LSM-02-RRM</b>	<b>LSM-20A-RRM</b>	<b>LSM-11S-RRM</b>
-----------------	-------------------	--------------------	--------------------

<b>LSM-XS</b>	<b>LSM-02-S</b>	<b>LSM-20A-S</b>	<b>LSM-11S-S</b>
---------------	-----------------	------------------	------------------

**Note**

① For operating head dimensions, see Page 20.

# 2.3

## Limit Switches

### LS-Titan Miniature DIN Switches

2

#### Understanding LS-Titan Electronic Safety Position Switches

All four LS-Titan LSE switch bodies are safety-rated products. The LSE-11 and LSE-02 switch bodies both have a freely programmable operating point and can be individually adjusted to suit the application, and can be changed as often as required. These devices feature an LED on the body, providing simple indication during programming and operation.

The LSE-AI (4–20 mA) and LSE-AU (0–10V) analog position switches take position data and convert to an analog current or voltage value that can then be continuously fed into an automation system. These two switches also feature a diagnostic output for additional data processing.

This ensures that a safe operating state can be monitored and evaluated at any time. A self-test function is also present on these models. Outputs Q1 and Q2 are continuously tested for overloads, short circuits to 0V and short circuits to +U<sub>e</sub>.

Like the electromechanical position switches, LS-Titan electronic position switches meet Category 3 or 4 of the EN 954-1 standard for machine safety when configured as a redundant system. All devices are thus suitable for safety applications that are used for the protection of persons or processes.

#### Operating Point Adjustment

##### LSE-11

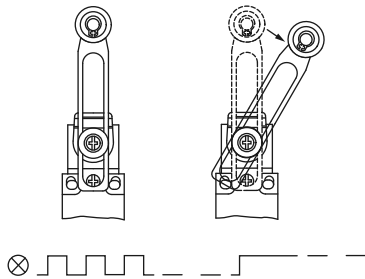

##### LSE-02

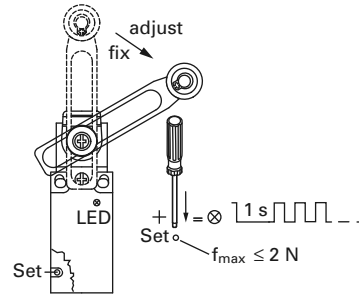

**Note:** LSE-11 and LSE-02—individual operating point adjustment.

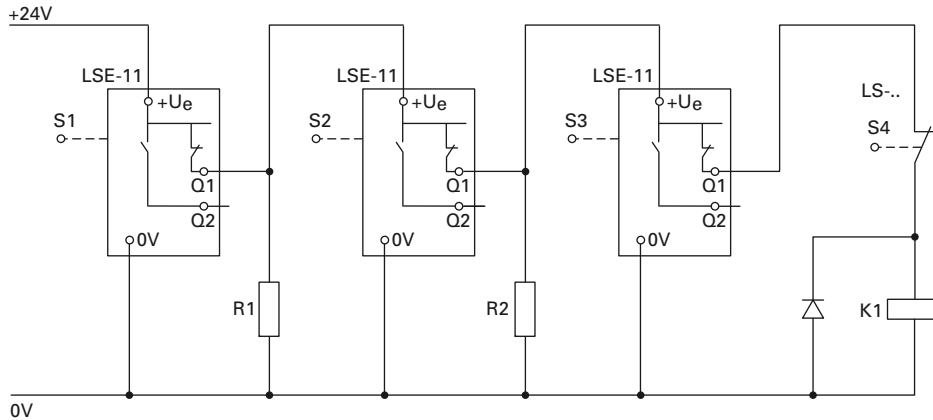

#### Example of LS-Titan LSE Models in a Safety-Oriented Circuit



**Note:** LSE-11 and LSE-02 can be used in safety circuits.  
 S1 is connected to 24 Vdc  
 S2, S3 each switch with a delay of 0.7s  
 R1, R2, e.g., series element M22-XLED60 (2820 ohms/0.5W)

Accessories

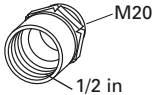
LS-Titan Safety Switches

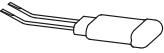
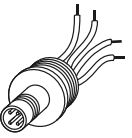
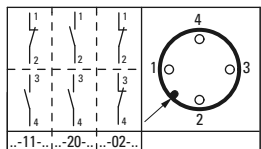
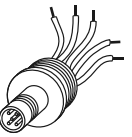
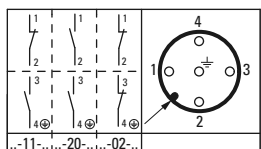
	For Use With	Description	Notes	Catalog Number
<b>V1-2-M20</b> 	Any	M20 screw terminal in 1/2". For use with American pipe thread, metal.	The screw connection must be earthed. Not total insulation.	<b>V1-2-M20-NA</b>
	Any	M20 screw terminal in 1/2". For use with American pipe thread, molded material.	—	<b>V1-2-M20</b>
<b>EMS20</b> 	Any	M20 diaphragm bolt. With internal push-through membrane. Will fit cable with an external diameter of up to 13 mm. Rated IP65 with cable inserted.	—	<b>EMS20</b>
<b>LS-XTW</b> 	Any	Cage Clamp tool.	—	<b>LS-XTW</b>
<b>MS12A</b> 	LS-Titan plastic bodies (LS-)	Plug connector, 12 mm, 4-pin male connector M12x1 (M12x1). Rated IP65. Molded material. Color coded to IEC/EN 60947-5-2.		<b>MS12A</b>
<b>MS12A5</b> 	LS-Titan metal bodies (LSM-)	Plug connector, 12 mm, 5-pin male connector (M12x1). Rated IP65. Molded material. Color coded to IEC/EN 60947-5-2.		<b>MS12A5</b>

# 2.3

## Limit Switches

### LS-Titan Miniature DIN Switches

#### Technical Data and Specifications

#### LS-Titan Miniature DIN Switches—IP66, IP67 Complete Units

2

Units			LS, LSM	LSE-11/LSE-02	LSE-AI ①	LSE-AU ①
<b>General</b>						
Standards			IEC/EN 60947	IEC/EN 60947 EN 61000-4	IEC/EN 60947 EN 61000-4	IEC/EN 60947 EN 61000-4
Climatic proofing			Damp heat, constant, to IEC 60068-2-78; damp heat, cyclical, to IEC 60068-2-30	Damp heat, constant, to IEC 60068-2-78; damp heat, cyclical, to IEC 60068-2-30	Damp heat, constant, to IEC 60068-2-78; damp heat, cyclical, to IEC 60068-2-30	Damp heat, constant, to IEC 60068-2-78; damp heat, cyclical, to IEC 60068-2-30
Ambient temperature		°C	–25 to +70	–25 to +70	–25 to +70	–25 to +70
Mounting position			As required	As required	As required	As required
Protection type			IP66, IP67	IP66, IP67	IP66, IP67	IP66, IP67
Terminal capacity of screw terminal and Cage Clamp						
Solid		mm <sup>2</sup>	1 x (0.5–2.5)	1 x (0.5–2.5)	1 x (0.5–2.5)	1 x (0.5–2.5)
Flexible with ferrules to DIN 46228		mm <sup>2</sup>	1 x (0.5–1.5)	1 x (0.5–1.5)	1 x (0.5–1.5)	1 x (0.5–1.5)
<b>Power Supply</b>						
Rated voltage		U <sub>e</sub> Vdc	N/A	12–30	24 (–15%/+20%)	24 (–15%/+20%)
Burden current						
12V		I <sub>e</sub> mA	N/A	15	N/A	N/A
24V		I <sub>e</sub> mA	N/A	18	28–45	24
30V		I mA	N/A	19	N/A	N/A
<b>Contacts/Switching Capacity</b>						
Rated impulse withstand voltage		U <sub>imp</sub> Vac	4000	N/A	N/A	N/A
Rated insulation voltage		U <sub>i</sub> V	400	N/A	N/A	N/A
Overvoltage category/ pollution degree			III/3	III/3	N/A	N/A
<b>Rated Operational Current</b>						
AC-15						
24V		I <sub>e</sub> A	6	N/A	N/A	N/A
230V/240V		I <sub>e</sub> A	6	N/A	N/A	N/A
400V/415V		I <sub>e</sub> A	4	N/A	N/A	N/A
DC-13						
24V		I <sub>e</sub> A	3	0.2	N/A	N/A
110V		I <sub>e</sub> A	0.8	N/A	N/A	N/A
220V		I <sub>e</sub> A	0.3	N/A	N/A	N/A

**Note**

① The following applies for LSE-11 and LSE-02: ensure that the power supply operates correctly when setting the operating point.

## LS-Titan Miniature DIN Switches—IP66, IP67 Complete Units. continued

	Units	LS, LSM	LSE-11/LSE-02	LSE-AI ①	LSE-AU ①
<b>Burden Current, continued</b>					
Analog output Q1					
Output voltage (max. 10 mA)	Vdc	N/A	N/A		0–10
Output current	mA	N/A	N/A	4–20	
Fault scenario	V	N/A	N/A	0	0
Resolution	Steps	N/A	N/A	100	100
Step tolerance	Steps	N/A	N/A	1	1
Shunt resistor, resistive load	ohms	N/A	N/A	<400	>1000
Digital diagnostics output Q2 (switching to + pole PNP)					
Response threshold	V	N/A	N/A	Approx. $U_e$	Approx. $U_e$
	mA	N/A	N/A	<200	<200
Control circuit reliability					
At 24 Vdc/5 mA	$H_F$	Fault probability	$<10^{-7}$ , <1 fault in $10^7$ operations	N/A	N/A
At 5 Vdc/1 mA	$H_F$	Fault probability	$<10^{-6}$ , <1 failure at $5 \times 10^6$ operations	N/A	N/A
Supply frequency	Hz	Max. 400	N/A	N/A	N/A
Short-circuit rating to IEC/EN 60947-5-1					
Maximum fuse	A gG/gL	6	N/A	N/A	N/A
Repetition accuracy	mm	$\pm 0.02$	$\pm 0.02$	$\pm 0.02$	$\pm 0.02$

**Note**

① The following applies for LSE-11 and LSE-02: ensure that the power supply operates correctly when setting the operating point.

# 2.3

## Limit Switches

### LS-Titan Miniature DIN Switches

#### LS-Titan Miniature DIN Switches—IP66, IP67 Complete Units

2

	Units	LS, LSM	LSE-11/LSE-02	LSE-AI/LSE-AU	LSE-AI/LSE-AU
<b>Mechanical Variables</b>					
Lifespan					
Standard-action contact	Operations	X 10 <sup>6</sup> 8	N/A	N/A	N/A
Snap-action contact	Operations	X 10 <sup>6</sup> 8	3 (electronic)	N/A	N/A
Contact temperature of roller head	°C	≤100	≤100	≤100	≤100
Mechanical shock resistance (half-sinusoidal shock, 20 ms)					
Standard-action contact	g	25	N/A	N/A	N/A
Snap-action contact	g	N/A	N/A	N/A	N/A
Basic unit	g	N/A	30	30	30
Operating frequency	Operations/h	≤6000	≤3000	≤3000	≤3000
Switching point		N/A	0.5–5.5 mm freely adjustable	N/A	N/A
Hysteresis	mm	N/A	0.4	0.4	0.4
Contact sequence (contact closed open Zw = positive opening clearance)	mm	N/A	0.04	0.06	0.06
<b>Actuation</b>					
Mechanical					
Actuating force at beginning/end of stroke					
Basic units	N	1.0/8.0	3.5/8.0	3.5/8.0	3.5/8.0
LS(M)-XP	N	1.0/8.0	1.0/8.0	1.0/8.0	1.0/8.0
LS(M)-XL	N	1.0/8.0	1.0/8.0	1.0/8.0	1.0/8.0
LS(M)-XLA	N	1.0/8.0	1.0/8.0	1.0/8.0	1.0/8.0
Actuating torque of rotary drives	Nm	0.2	0.2	0.2	0.2
Maximum operating speed with DIN cam					
Basic units for angle of actuation	$\alpha = 0^\circ/30^\circ$	m/s 1/0.5	1/0.5	1/0.5	1/0.5
LS(M)-XRL for angle of actuation	$\alpha = 0^\circ$	m/s 1.5	1.5	1.5	1.5
LS(M)-XRLA for angle of actuation	$\alpha = 30^\circ, L = 125 \text{ mm}$	m/s 1.5	1.5	1.5	1.5
LS(M)-XRR for angle of actuation	$L = 130 \text{ mm}$	m/s 1.5	1.5	1.5	1.5
LS(M)-XL for angle of actuation	$\alpha = 30^\circ/45^\circ$	m/s 1	1	1	1
LS(M)-XLA for angle of actuation	$\alpha = 30^\circ/45^\circ$	m/s 1	1	1	1
LS(M)-XP for angle of actuation	$\alpha = 0^\circ/30^\circ$	m/s 1/1	1/1	1/1	1/1
<b>Electromagnetic Compatibility (EMC)</b>					
Electrostatic discharge (IEC/EN 61000-4-2, Level 3 ESD)					
Air discharge	kV		8	8	8
Contact discharge	kV		4	4	4
Electromagnetic fields (IEC/EN 61000-403, RFI)	V/m		10	10	10
Burst pulses (IEC/EN 61000-4-4, Level 3)					
Supply cables	kV		2	2	2
Signal lines	kV		2	2	2
High-energy pulses (surge) (IEC/EN 61000-4-5)	kV		0.5	0.5	0.5
Immunity to line-conducted interference to (IEC/EN 61000-4-6)	V		10	10	10



Contact Travel Diagrams

LSE

Contact Travel

■ = contact closed  
□ = contact open

LSE-11

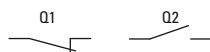

LSE-02

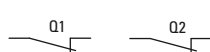

Description

Basic Units

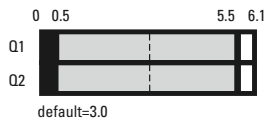
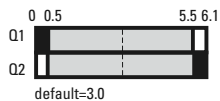

Operating Heads

Roller plunger

LS-XP  
LSM-XP

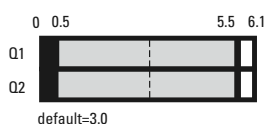
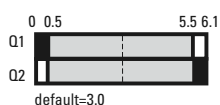

Roller lever

LS-XL  
LSM-XL  
LS-XL  
LS-XLB

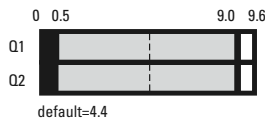
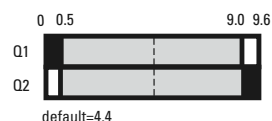

Angled roller lever

LS-XLA  
LSM-XLA

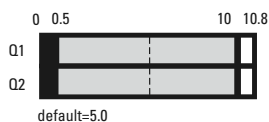
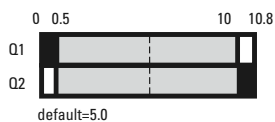

Rotary lever

LS-XRL  
LSM-XRL

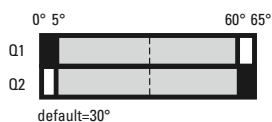

Adjustable roller lever

LS-XRLA  
LSM-XRLA  
LS-XRLA30  
LS-XRLA40  
LS-XRLA40R

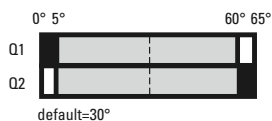

Actuating rod

LS-XRR  
LSM-XRR  
LS-XRRM  
LSM-XRRM

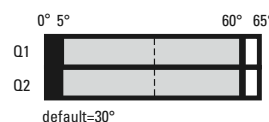
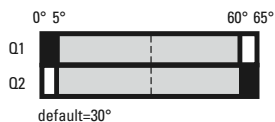

Spring rod

LS-XS  
LSM-XS



# 2.3

## Limit Switches

### LS-Titan Miniature DIN Switches

#### LS and LSM

2

#### Contact Travel

■ = contact closed  
□ = contact open

#### LS-02, LS-S02, LSM-02

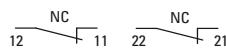

#### LS-11S, LS-S11S, LSM-11S

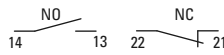

#### LS-20A, LS-S20A, LSM-20A

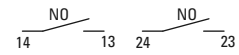

#### Description

#### Basic Units

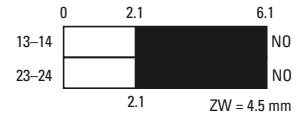
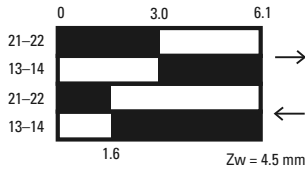
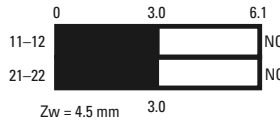

#### Operating Heads

##### Roller plunger

LS-XP, LSM-XP

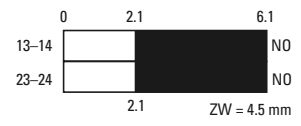
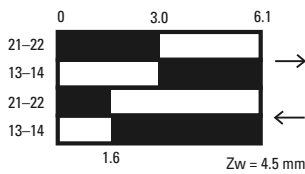
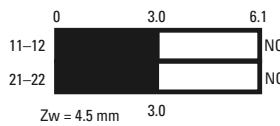

##### Roller lever

LS-XL, LSM-XL

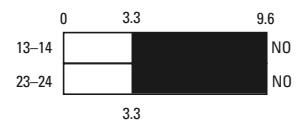
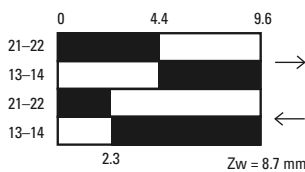
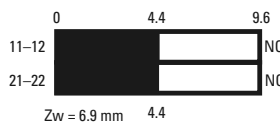

##### Roller lever, short

LS-XLS

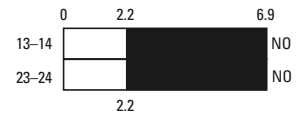
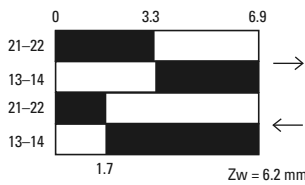
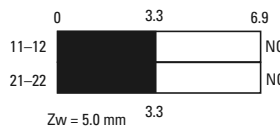

##### Roller lever, large

LS-XLB

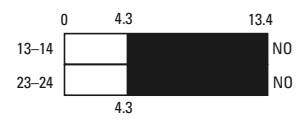
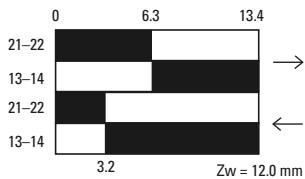
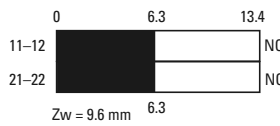

LS and LSM, continued

Contact Travel
= contact closed
= contact open

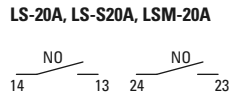
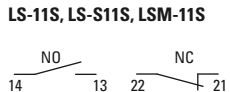
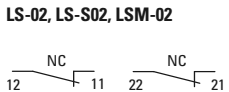

Description

Operating Heads

Angled roller lever

LS-XLA, LSM-XLA

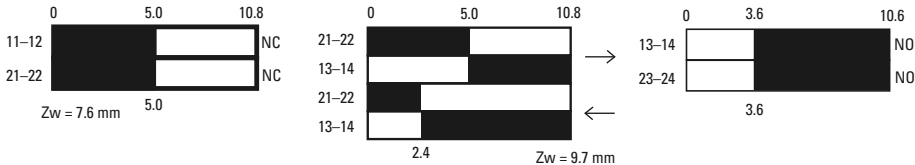

Rotary lever

LS-XRL, LSM-XRL

Adjustable roller lever

LS-XRLA, LSM-XRLA
LS-XRLA30, LS-XRLA40
LS-XRLA40R

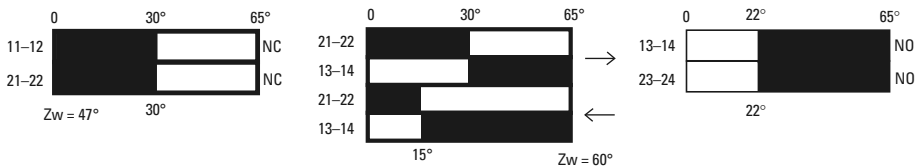

Actuating rod

LS-XRR, LSM-XRR
LS-XRRM, LSM-XRRM

Spring rod

LS-XS, LSM-XS

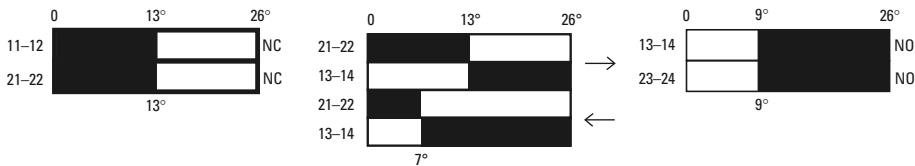

# 2.3

## Limit Switches

### LS-Titan Miniature DIN Switches

#### Dimensions

Approximate Dimensions in Inches (mm)

2

#### Position Switches

##### LS-..., LSM-..., LSE-...

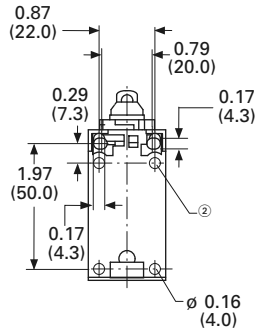
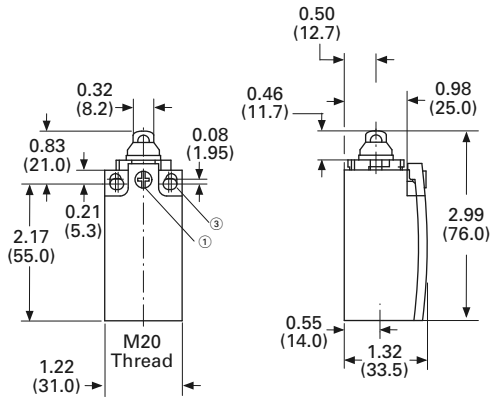

##### LS-..., LSM-..., LSE-...

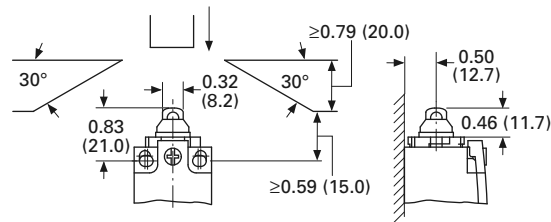

##### LS(M)-.../S

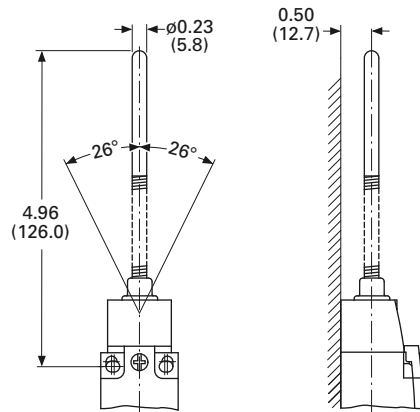

##### LS(M)-.../P

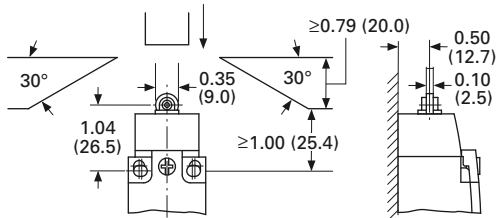

#### Notes

- ① Tightening torque of cover screws: 0.8 Nm ±0.2 Nm.
- ② Only with LS (insulated version).
- ③ Fixing screws 2 x M4 ≥30  
M<sub>A</sub> = 1.5 Nm

Approximate Dimensions in Inches (mm)

### Rotary Lever

LS(M)-.../RL

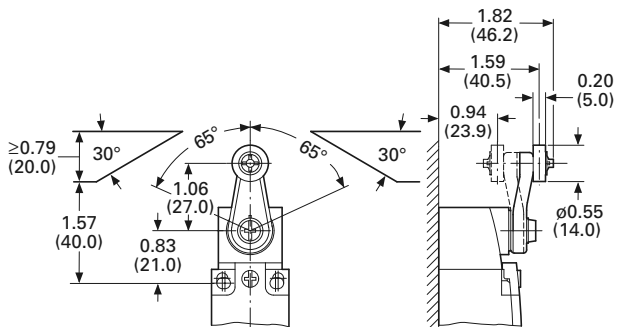

### Roller Lever, Short

LS(M)-.../LS

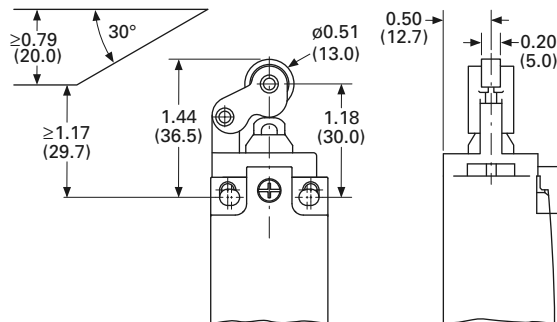

### Roller Lever

LS(M)-.../L

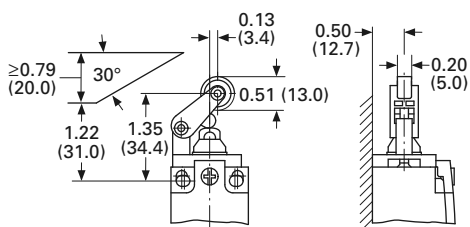

### Adjustable Roller Lever

LS(M)-.../RLA

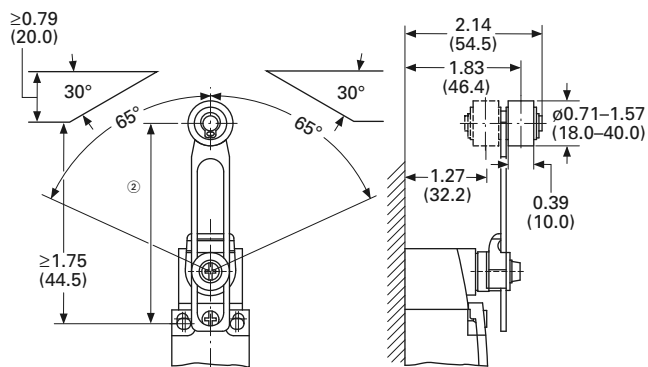

### Roller Lever, Large

LS(M)-.../LB ①

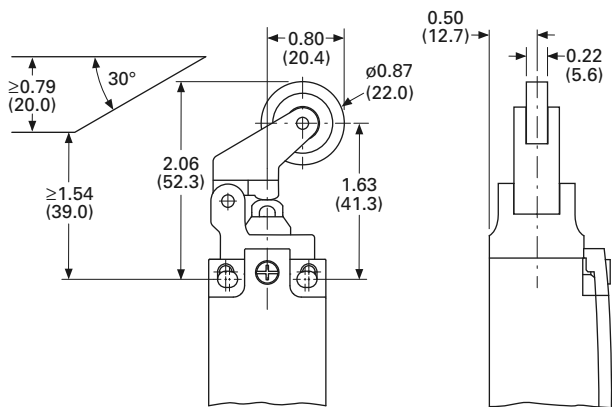

### Angled Roller Lever

LS(M)-.../XLA

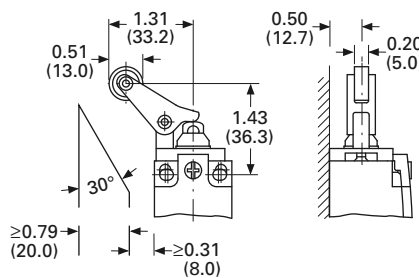

#### Notes

- ① Tightening torque of cover screws: 0.8 Nm ±0.2 Nm.
- ② Setting range of 54.5 to 97.

# 2.3

## Limit Switches

### LS-Titan Miniature DIN Switches

Approximate Dimensions in Inches (mm)

2

#### Actuating Rod

LS(M)-.../RR

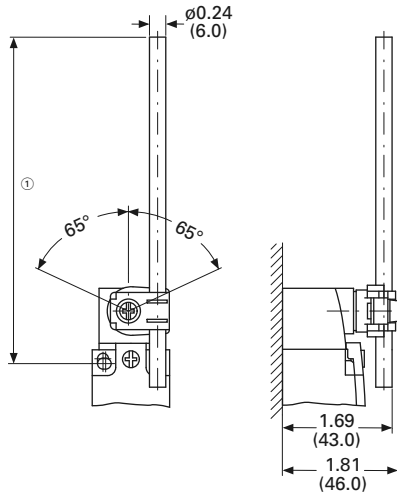

LS(M)-.../OR

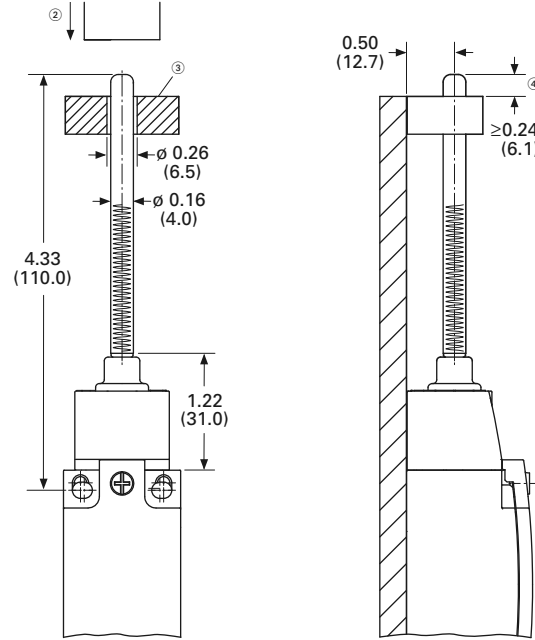

#### Notes

- ① LS.../RR ≤ 150  
LS.../RRM ≤ 210
- ② Approach direction, vertical.
- ③ Guide is done by customer, not included.
- ④ Maximum push-through.