

## Micro PLCs MicroSmart



### Overview

IDEC MicroSmart series PLC is the next generation of programmable logic controller. These flexible, adaptable PLCs are as compact as they are powerful, so you can create the system you need without increasing your space requirements or your budget.

MicroSmart CPUs are available with built-in 10, 16, and 24 I/O All-In-One units, and 20 and 40 I/O slim style models.

Each MicroSmart CPU is designed in a compact and rugged housing. Every MicroSmart module meets IDEC strict quality standards and complies with all major international standards; cULus, CE, TUV, and Lloyds.

Each CPU is equipped with a standard power supply circuit, four high-speed counters, analog potentiometer, and password protection.

The Slim type and the 24 I/O All-in-one CPU can be expanded with the many choices of expansion

modules. There are 20 modules available including four analog I/O modules, an AS-interface master communication module, and our most recent addition to the MicroSmart family, the 8-pt AC input module. In addition, 24V DC All-in-one CPUs are now available. Depending upon the CPU, you can create a system with as many as 264 I/Os.

Each MicroSmart module can be enhanced with a memory cartridge for easy maintenance, a real-time clock and calendar cartridge for real time applications, and an RS-485/RS-232 communications adapter. These adapters allow the MicroSmart CPU to data link to the MicroSmart or other IDEC PLCs, connect to operator interfaces, printers, barcode readers, or other RS-232 devices such as modems for remote communication.

MicroSmart PLCs are programmable with WindLDR, IDEC's intuitive ladder logic software. The current WindLDR version 5.03 has improved features such as a split ladder window for easy navigation, improved tag name editor and rung comment search. Download your free demo now or upgrade to WindLDR 5.03 if you have version 4.0 or later.

## Key Features

- Available in Slim or All-In-One styles
- CPU units are equipped with 10, 16, 20, 24, or 40 I/Os.
- Maximum of 264 I/Os can be configured on a single MicroSmart CPU
- Your choice of many expansion modules: AC/DC inputs, relay/transistor outputs, RTD/ Thermocouple and Analog I/Os, and AS-interface Master communication module
- Standard RS232 port, optional plug-in RS485/RS232 port for data link or modem communications
- Optional plug-in HMI module for monitoring, memory cartridge, and real-time clock and calendar cartridge
- Built in Modbus-CRC, PID and Ramp functions
- 4 built-in high speed counters, interrupt and catch inputs, and password protection
- Data link for up to 32 MicroSmart or other IDEC PLCs
- cULus, CE, TUV and Lloyds approved
- Approved for Class 1 Div 2 Hazardous Locations
- Easy programming using IDEC exclusive WindLDR software
- New web server module for faster, easier ethernet connectivity

## MicroSmart Series

### FC4A-C24R2C

[The MicroSmart is available in either Slim type or the All-In-One type with expandability up to 264 I/O.]





## Product Specifications

<b>PLC Product Category</b>	CPU Unit
<b>Operating Voltage</b>	24V DC
<b>Maximum PID Loops</b>	8
<b>High Speed Counter(s)</b>	20kHz, 5kHz

**High Speed Counter Input Type** Sink, Source

**RS485 Ports** 1, Separate Module Required

**On Board Communication Port** 1 RS-232

**Memory Card Slot** Yes

**On Board Input Type** Transistor Sink, Transistor Source

**On Board Output Type** Relay

**I/O Expandable** Yes

**Maximum I/O** 88

**On Board I/O** 14/10

**Real Time Clock** Yes, Separate Module Required

**Connector Type** Screw Terminal

### Notes

MicroSmart All-in-One Brick Style PLC. Expandable I/O cards purchased separately. See catalog pages for further information.

**I/O Range Requirement** 24 or less, 25-88

**Floating Point Math** No

**Data Processing** 16 Bit

**Max. Communication Ports** 1, 2

**Maximum Analog Points** 8 Input / 4 Output

### MicroSmart Performance

**Features:**

- Available in 10, 16, 20, 24, and 40 I/O CPUs.
- PID Controls
  - Program up to 14 PID loops
- High Speed I/O
  - Built-in 4 high speed inputs
  - Single or Dual Phase
  - Max. 20KHz frequency
- Built-in 2 High speed outputs (Slim model only)
- Configure up to 264 I/O Points
- Data link up to 32 MicroSmart and Pentra CPUs
- Using RS485 communication module/port, you can create a network of up to 32 CPUs.
- Worldwide Approvals
  - cULus listed, CE marked
  - Class 1 Div. 2 for hazardous locations
  - Lloyds Registered and ABS approved for shipping industry



PLCs

Operator Interfaces

Automation Software

Power Supplies

Sensors

Communication & Networking

### MicroSmart CPU Part Numbers

**All-in-One**

Appearance	Part Number	Power	I/O Points	Input	Output	Expandability	
	FC4A-C10R2C	24V DC	10 (6 in/ 4 out)			N/A	
	FC4A-C10R2	100-240V AC					
	FC4A-C16R2C	24V DC	16 (9 in/ 7 out)	24V DC (Sink/Source)	Relay		
	FC4A-C16R2	100-240V AC					
	FC4A-C24R2C	24V DC	24 (14 in/ 10 out)				88 Maximum I/O (up to 4 expansion modules)
	FC4A-C24R2	100-240V AC					

## Specifications

**All-in-One**

Part Number	AC Power	FC5A-C10R2	FC5A-C16R2	FC5A-C24R2	FC4A-C10R2	FC4A-C16R2	FC4A-C24R2
	DC Power	FC5A-C10R2C	FC5A-C16R2C	FC5A-C24R2C	FC4A-C10R2C	FC4A-C16R2C	FC4A-C24R2C
Rated Voltage	AC power model: 100 to 240V AC, DC power model: 24V DC						
Allowable Voltage Range	AC power model: 85 to 264V AC, DC power model: 20.4 to 28.8V DC (including ripple)						
Rated Power Frequency	AC power model: 50/60 Hz (47 to 63 Hz)						
Maximum Input Current	250mA (85V AC) 160mA (24V DC)	300mA (85V AC) 190mA (24V DC)	450mA (85V AC) <sup>1</sup> 360mA (24V DC) <sup>2</sup>	250mA (85V AC) 160mA (24V DC)	300mA (85V AC) 190mA (24V DC)	450mA (85V AC) <sup>2</sup> 360mA (24V DC) <sup>3</sup>	
Maximum Power Consumption	AC Power	FC5A-C10R2/FC4A-C10R2: 30VA (264V AC) / 20VA (100V AC) <sup>3</sup> FC5A-C16R2/FC4A-C16R2: 31VA (264V AC) / 22VA (100V AC) <sup>3</sup> FC5A-C24R2/FC4A-C24R2: 40VA (264V AC) / 33VA (100V AC) <sup>1</sup>					
	DC Power	FC5A-C10R2C/FC4A-C10R2C: 3.9W (24V DC) <sup>4</sup> FC5A-C16R2C/FC4A-C16R2C: 4.6W (24V DC) <sup>4</sup> FC5A-C24R2C/FC4A-C24R2C: 8.7W (24V DC) <sup>2</sup>					
Allowable Momentary Power Interruption	10ms (rated power voltage)						
Dielectric Strength	Between power and ⊕ or ⊖ terminals: 1500V AC, 1 minute Between I/O and ⊕ or ⊖ terminals: 1500V AC, 1 minute						
Insulation Resistance	Between power and ⊕ or ⊖ terminals: 10 MΩ minimum (500V DC megger) Between I/O and ⊕ or ⊖ terminals: 10 MΩ minimum (500V DC megger)						
Noise Resistance	AC power terminals: 1.5 kV, 50 ns to 1μs DC power terminals: 1.0 kV, 50 ns to 1μs I/O terminals (coupling clamp): 1.5 kV, 50 ns to 1μs						
Inrush Current		35A	40A	35A	40A		
Power Supply Wire	UL1015 AWG22, UL1007 AWG18						
Operating Temperature	0 to 55°C						
Storage Temperature	-25 to +70°C (no freezing)						
Relative Humidity	Level RH1 (IEC61131-2), 1 to 95% RH (no condensation)						
Altitude	Operation: 0 to 2,000m, Transport: 0 to 3,000m						
Pollution Degree	2 (IEC60664-1)						
Corrosion Immunity	Free from corrosive gases						
Degree of Protection	IP20 (IEC60529)						
Grounding Wire	UL1007, AWG16						
Vibration Resistance	When mounted on a DIN rail or panel surface: 5 to 9 Hz amplitude 3.5 mm, 9 to 150 Hz acceleration 9.8 m/s <sup>2</sup> (1G), 2 hours per axis on each of three mutually perpendicular axes (IEC61131-2)						
Shock Resistance	147 m/s <sup>2</sup> (15G), 11ms duration, 3 shocks per axis, on three mutually perpendicular axes (IEC61131)						
Weight	AC: 230g DC: 240g	AC: 250g DC: 260g	AC: 305g DC: 310g	AC: 230g DC: 240g	AC: 250g DC: 260g	AC: 305g DC: 310g	

1. CPU module (including 250mA sensor power) + 4 I/O modules  
2. CPU module + 4 I/O modules  
3. CPU module (including 250mA sensor power)  
4. CPU module (24V DC)

**PLCs**
**Operator Interfaces**
**Automation Software**
**Power Supplies**
**Sensors**
**Communication & Networking**

**All-in-One**

Part Number		FC5A-C10R2 FC5A-C10R2C	FC5A-C16R2 FC5A-C16R2C	FC5A-C24R2 FC5A-C24R2C	FC4A-C10R2 FC4A-C10R2C	FC4A-C16R2 FC4A-C16R2C	FC4A-C24R2 FC4A-C24R2C		
Control System		Stored program system							
Instruction Words		35 basic							
Program Capacity <sup>1</sup>		13.8 KB (2,300 steps)	27 KB (4,500 steps)	54 KB (9,000 steps)	4.8 KB (800 steps)	15 KB (2,500 steps)	27 KB (4,500 steps)		
User Program Storage		EEPROM (10,000 times rewritable)							
Processing Time	Basic Instruction	1.16ms (1,000 steps)			1.65ms (1,000 steps)				
	END Processing <sup>2</sup>	0.64ms			0.64ms				
Expandable I/O Module		—		4 modules	—		4 modules		
I/O Points	Input	6	9	14	Expansion: 64	6	9	14	Expansion: 64
	Output	4	7	10		4	7	10	
Internal Relay		2,048 points			256 points	1,024 points			
Shift Register		128 points			64 points	128 points			
Data Register		2,000 points			400 points	1,300 points			
Extra Data Register		—			—				
Counter		256 points			32 points	100 points			
Timer (1-sec, 100-ms, 10-ms, 1-ms)		256 points			32 points	100 points			
RAM Backup	Backup Data	Internal relay, shift register, counter, data register							
	Backup Duration	Approx. 30 days (typical) at 25°C after backup battery fully charged							
	Battery	Lithium secondary battery							
	Charging Time	Approx. 15 hours for charging from 0% to 90% of full charge							
	Battery Life	5 years							
	Replaceability	N/A							
Self-diagnostic Function		Power failure, watchdog timer, data link connection, user program EEPROM sum check, timer/counter preset value sum check, user program RAM sum check, keep data, user program syntax, user program writing, CPU module, clock IC, I/O bus initialize, user program execution							
Input Filter		Without filter or 3 to 15ms filter (selectable in increments of 1ms)							
Catch Input/Interrupt Input		Four inputs (I2 through I5) Minimum turn on pulse width: 40µs minimum Minimum turn off pulse width: 150µs minimum							
High-speed Counter	Maximum Counting Frequency and High-speed Counter Points	Total 4 points Single/two-phase selectable: 50KHz (1 point) Single-phase: 5KHz (3 points)			Total 4 points Single/two-phase selectable: 20KHz (1 point) Single-phase: 5KHz (3 points)				
	Counting Range	0 to 65535 (16 bits)							
	Operation Mode	Rotary encoder mode and adding counter mode							
Analog Potentiometer	Number	1 point		2 points	1 point		2 points		
	Data Range	0 to 255							
Analog Voltage Input	Number	—							
	Input Voltage Range	—							
	Input Impedance	—							
Pulse Output	Data Range	—							
	Number	—							
Sensor Power Supply (AC Power Only)	Max. Frequency	—							
	Output Voltage Current	24V DC (+10% to -15%), 250mA							
	Overload Detection	N/A							
Isolation		Isolated from the internal circuit							
Port 1		RS232C (maintenance communication, user communication)							
Port 2 Communication Adapter (option) <sup>3</sup>		Possible	Possible	Possible	—	Possible	Possible		
Clock Cartridge (option)		Possible	Possible	Possible	Possible	Possible	Possible		
Memory Cartridge (option)		Possible	Possible	Possible	Possible	Possible	Possible		
HMI Module (option)		Possible	Possible	Possible	Possible	Possible	Possible		



- 1 step equals 6 bytes.
  - Not including expansion I/O service time, clock function processing time, data link processing time, and interrupt processing time.
  - Maintenance communication, user communication, Modem communication, datalink, Modbus master/slave communication (FC5A only).
- Note: The maximum number of relay outputs that can be turned on simultaneously is 33 including those on the CPU module.

Communication Port (RS232C Port 1)

Model	Slim CPU	All-in-One CPU
Standards	EIA RS232C	
Maximum Baud Rate	FC5A: 57,600 bps (maintenance communication) FC4A: 19,200 bps (maintenance communication)	
Maintenance Communication	Possible	
User Communication	Possible	
Modem Communication	N/A	
Data Link	N/A	
Cable	Special cable (FC2A-KC4C, FC2A-KP1C, FC4A-KC1C, FC4A-KC2C)	
Isolation between Internal Circuit and Communication Port	Not isolated	

Input Specifications

Part Number	—	FC5A-D16RK1 FC5A-D16RS1	—	FC5A-D32K3 FC5A-D32S3	—	FC5A-C10R2 FC5A-C10R2C	FC5A-C16R2 FC5A-C16R2C	FC5A-C24R2 FC5A-C24R2C
	FC4A-D20K3 FC4A-D20S3	—	FC4A-D20RK1 FC4A-D20RS1	—	FC4A-D40K3 FC4A-D40S3	FC4A-C10R2 FC4A-C10R2C	FC4A-C16R2 FC4A-C16R2C	FC4A-C24R2 FC4A-C24R2C
Input Points	12 (12/1 common)	8 (8/1 common)	12 (12/1 common)	16 (8/1 common)	24 (12/1 common)	6 (6/1 common)	9 (9/1 common)	14 (14/1 common)
Input Voltage	24V DC sink/source input signal							
Input Voltage Range	20.4 to 26.4V DC					20.4 to 28.8V DC		
Input Current	FC5A I0, I1, I3, I4, I6, I7: 4.5mA/point (24V DC) I2, I5, I10 to I17: 7mA/point (24V DC) FC4A I0, I1, I6, I7: 5mA/point (24V DC) I2 to I5, I10 to I27: 7mA/point (24V DC)					FC5A I0 and I1: 6.4mA/point I2 to I7, I10 to I15: 7mA/point (24V DC) FC4A I0 and I1: 11mA I2 to I7, I10 to I15: 7mA/point (24V DC)		
Input Impedance	FC5A I0, I1, I3, I4, I6, I7: 4.9kΩ I2 to I5, I10 to I17: 3.4kΩ FC4A I0, I1, I6, I7: 5.7kΩ I2 to I5, I10 to I17: 3.4kΩ					FC5A I0 and I1: 3.7kΩ I2 to I7, I10 to I15: 3.4kΩ FC4A I0 and I1: 2.1kΩ I2 to I7, I10 to I15: 3.4kΩ		
Turn ON Time	FC5A I0, I1, I3, I4, I6, I7: 5μs + filter value I2 and I5: 35μs + filter value I10 to I17: 40μs + filter value FC4A I0, I1, I6, I7: 35μs + filter value I2 to I5: 35μs + filter value I10 to I27: 40μs + filter value					FC5A I0 and I1: 2μs + filter value I2 to I7: 35μs + filter value I6, I7, I10 to I15: 40μs + filter value FC4A I0 and I1: 35μs + filter value I2 to I5: 35μs + filter value I6, I7, I10 to I15: 40μs + filter value		
Turn OFF Time	FC5A I0, I1, I3, I4, I6, I7: 5μs + filter value I2 and I5: 150μs + filter value I10 to I17: 150μs + filter value FC4A I0, I1, I6, I7: 45μs + filter value I2 to I5: 150μs + filter value I10 to I27: 150μs + filter value					FC5A I0 and I1: 16μs + filter value I2 to I7: 150μs + filter value I6, I7, I10 to I15: 150μs + filter value FC4A I0 and I1: 45μs + filter value I2 to I5: 150μs + filter value I6, I7, I10 to I15: 150μs + filter value		
Connector	On Mother Board	FL26A2MA (Oki Electric Cable)	MC1.5/18-G-3.81BK (Phoenix Contact)	FL26A2MA (Oki Electric Cable)	—			
	Insertion Durability	100 times minimum					—	
Isolation	Between input terminals: Photocoupler isolated Internal circuit: Not isolated							
Input	Type 1 (IEC61131-2)							
External Load for I/O Interconnection	Not needed							
Single Determination Method	Static							
Effect of Improper Input Connection	Both sinking and sourcing input signals can be connected. If any input exceeding the rated value is applied, permanent damage may be caused.							
Cable Length	3 m in compliance with electromagnetic immunity							



**PLCs**
**Operator Interfaces**
**Automation Software**
**Power Supplies**
**Sensors**
**Communication & Networking**
**Transistor Sink and Source Output**

Part Number	—	FC5A-D16RK1 FC5A-D16RS1	FC5A-D32K3 FC5A-D32S3
	FC4A-D20RK1 FC4A-D20RS1	—	FC4A-D40K3 FC4A-D40S3
Output Points	2 (2/1 common)	2 (2/1 common)	16 (8/1 common)
Output	Transistor Sink	FC5A-D16K1/D32K3 FC4A-D20K3/D20RK1/D40K3	
	Transistor Source	FC5A-D16RS1/D32S3 FC4A-D20S3/D20RS1/D40S3	
Load Voltage	24V DC		
Operating Load Voltage Range	20.4 to 28.8V DC		
Load Current	0.3A per output point		
Maximum Load Current	1A per common		
Voltage Drop (ON Voltage)	1V maximum (voltage between COM and output terminals when output is on)		
Inrush Current	1A		
Leakage Current	0.1mA maximum		
Clamping Voltage	39V±1V		
Maximum Lamp Load	8W		
Inductive Load	L/R = 10ms (28.8V DC, 1 Hz)		
External Current Draw	Sink output: 100mA maximum, 24V DC (power voltage at the +V terminal) Source output: 100mA maximum, 24V DC (power voltage at the -V terminal)		
Isolation	Between output terminal and internal circuit: Photocoupler isolated Between output terminals: Not isolated		
Connector on Mother Board	FL26A2MA (Oki Electric Cable)	MC1.5/16-G-3.81BK (Phoenix Contact)	FL26A2MA (Oki Electric Cable)
Connector Insertion/Removal Durability	100 times minimum		
Output Delay	Turn ON Time	FC5A Q0 to Q2: 5µs max. Q3 to Q7, Q10 to Q17: 300µs max. FC4A Q0, Q1: 5µs max. Q2 to Q7, Q10 to Q17: 300µs max.	
	Turn OFF Time	FC5A Q0 to Q2: 5µs max. Q3 to Q7, Q10 to Q17: 300µs max. FC4A Q0, Q1: 5µs max. Q2 to Q7, Q10 to Q17: 300µs max.	

**Relay Output**

Part Number	FC5A-C10R2 FC5A-C10R2C	FC5A-C16R2 FC5A-C16R2C	FC5A-C24R2 FC5A-C24R2C	FC5A-D16RK1 FC5A-D16RS1	
	FC4A-C10R2 FC4A-C10R2C	FC4A-C16R2 FC4A-C16R2C	FC4A-C24R2 FC4A-C24R2C	FC4A-D20RK1 FC4A-D20RS1	
No. of Outputs	4	7	10	8	
Output Points per Common Line	COM0	3	4	4	2 (Transistor output)
	COM1	1	2	4	3
	COM2	—	1	1	2
	COM3	—	—	1	1
Output	1 NO form A				
Maximum Load Current	2A per point 8A per common line				
Minimum Switching Load	0.1mA/0.1V DC (reference value)				
Initial Contact Resistance	30 mΩ maximum				
Electrical Life	100,000 operations minimum (rated load 1,800 operations/hour)				
Mechanical Life	20,000,000 operations minimum (no load 18,000 operations/hour)				
Rated Load	240V AC/2A (resistive load, inductive load cos φ = 0.4) 30V DC/2A (resistive load, inductive load L/R = 7ms)				
Dielectric Strength	Between output and terminals: 1,500V AC, 1 minute Between output terminal and internal circuit: 1,500V AC, 1 minute Between output terminals (COMs): 1,500V AC, 1 minute				
Connector on Mother Board	—			*	
Connector Insertion/Removal Durability	—			100 times minimum	



\*MC1.5/16-G-3.81BK (Phoenix Contact)

PLCs

Operator Interfaces

Automation Software

Power Supplies

Sensors

Communication & Networking

Dimensions (mm)

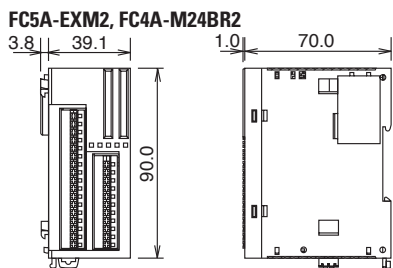
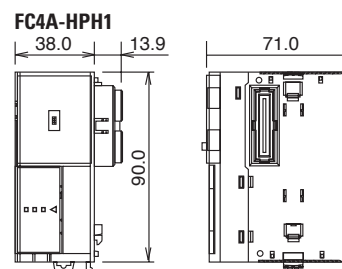
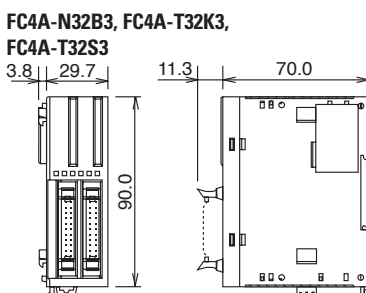
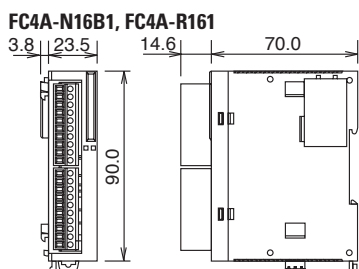
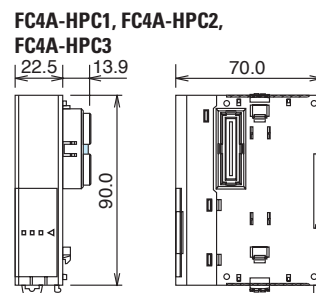
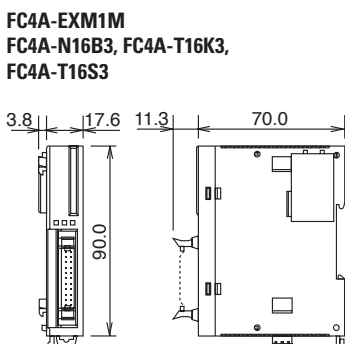
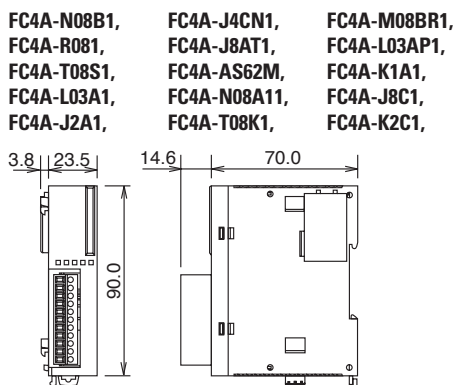
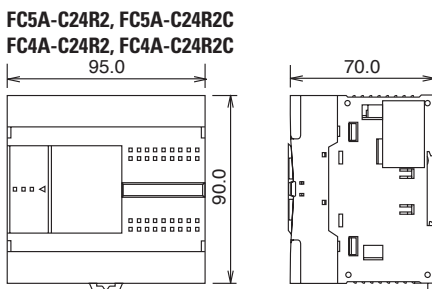
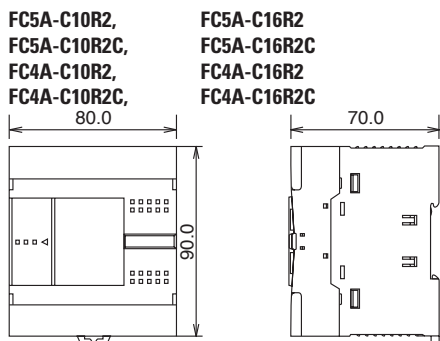
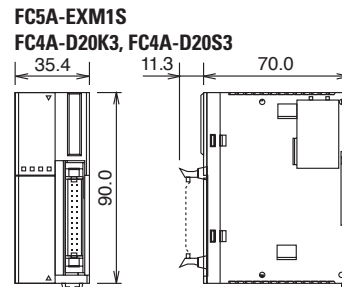
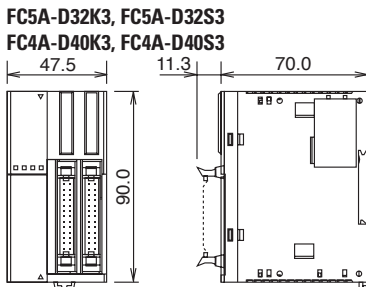
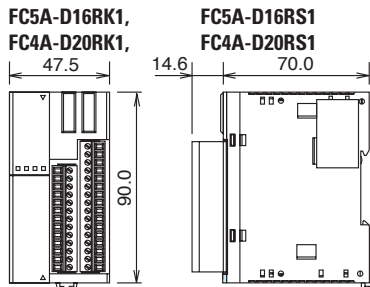

Example

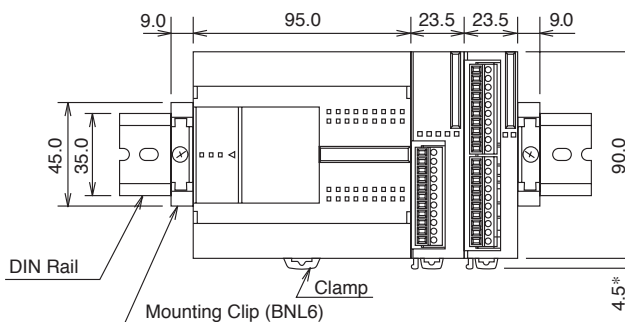

The figure illustrates a system setup consisting of the all-in-one 24-I/O CPU module, an 8-point relay output module, and a 16-point DC input module mounted on a 35-mm-wide-DIN rail using BNL6 mounting clips.

Mounting Hole Layout (mm)

FC5A-C10R2, FC5A-C16R2  
 FC5A-C10R2C, FC5A-C16R2C  
 FC4A-C10R2, FC4A-C16R2  
 FC4A-C10R2C, FC4A-C16R2C

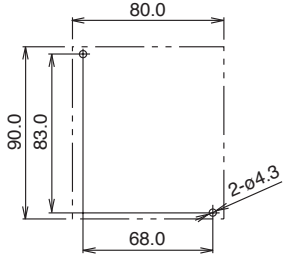

FC4A-N08A11, FC4A-R081  
 FC4A-R161, FC4A-T08K1  
 FC4A-T08S1, FC4A-M08BR1  
 FC4A-L03A1, FC4A-L03AP1  
 FC4A-J2A1, FC4A-K1A1  
 FC4A-J4CN1, FC4A-T8C1  
 FC4A-J8AT1, FC4A-K2C1

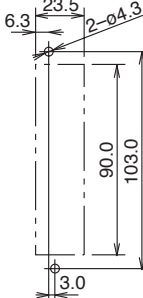

FC5A-EXM2  
 FC4A-M24BR2

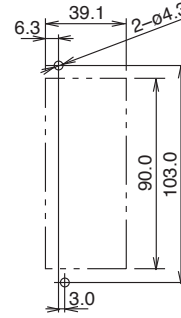

FC5A-EXM1S, FC4A-D20K3  
 FC4A-D20S3

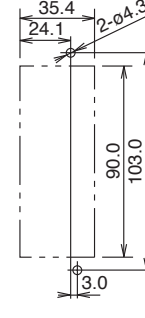

FC5A-C24R2, FC4A-C24R2C  
 FC4A-C24R2, FC4A-C24R2C

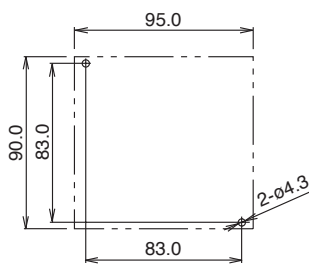

FC5A-EXM1M  
 FC4A-N16B3, FC4A-T16K3,  
 FC4A-T16S3

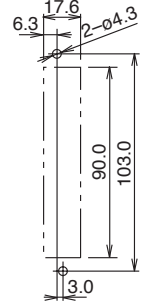

FC4A-HPC1 FC4A-HPC2  
 FC4A-HPC3

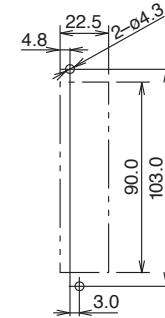

FC4A-N32B3, FC4A-T32K3,  
 FC4A-T32S3

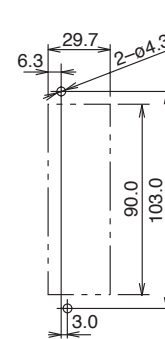

FC5A-D16RK1  
 FC5A-D16RS1  
 FC5A-D32K3  
 FC5A-D32S3  
 FC4A-D20RK1  
 FC4A-D20RS1  
 FC4A-D40K3  
 FC4A-D40S3

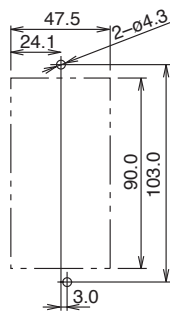

FC4A-HPH1

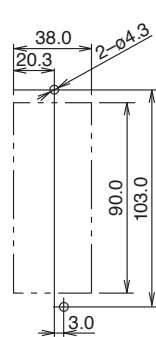

FC4A-HPH1

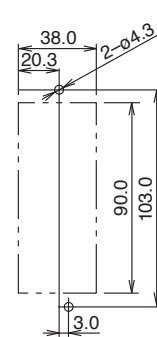

Examples

Mounting hole layout for FC5A-C24R2 or FC4A-C24R2 and four 23.5mm-wide I/O modules

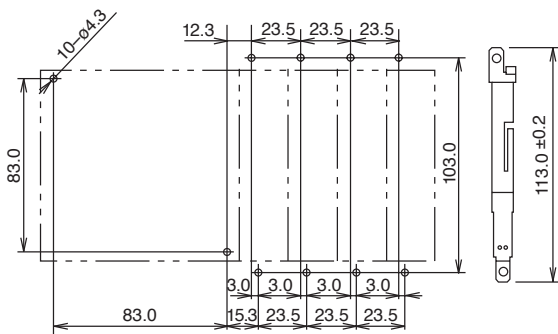

Mounting hole layout from left, FC4A-HPH1, FC4A-D20K3, FC4A-N16B3, FC4A-N32B3, and FC4A-M24BR2 modules

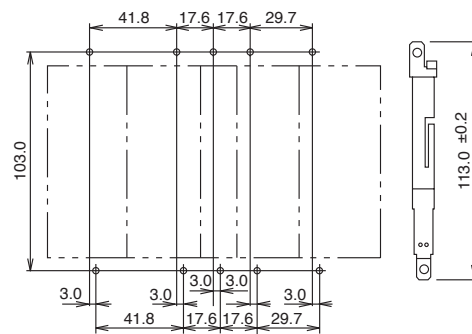

## Web Server

### General Specifications

<b>Rated Power Voltage</b>	24V DC
<b>Allowable Voltage Range</b>	20.4 to 26.4V DC
<b>Current Draw</b>	70 mA
<b>Allowable Momentary Power Interruption</b>	10 ms maximum
<b>Dielectric Strength</b>	500V AC, 1 minute
<b>Insulation Resistance</b>	10 MΩ minimum (500V DC megger)
<b>Noise Resistance</b>	DC power terminal: 1.0 kV, 50 ns to 1 μs Ethernet cable: 0.5 kV, 50 ns to 1 μs (coupling clamp)
<b>Inrush Current</b>	4A maximum
<b>Operating Temperature</b>	0 to 55°C
<b>Storage Temperature</b>	-40 to +70°C (no freezing)
<b>Relative Humidity</b>	10 to 95% (no condensation)
<b>Pollution Degree</b>	2 (IEC 60664-1)
<b>Corrosion Immunity</b>	Free from corrosive gases
<b>Degree of Protection</b>	IP20 (IEC60529)
<b>Vibration Resistance</b>	When mounted on a DIN rail: 5 to 9 Hz amplitude 3.5 mm 9 to 150 Hz acceleration 9.8 m/s <sup>2</sup> (1G) 2 hours in each of 3 axes
<b>Shock Resistance</b>	147 m/s <sup>2</sup> (15G), 11 ms duration 3 shocks each in 3 axes
<b>Weight (approx.)</b>	150g

### Interface Specifications

<b>Communication</b>	RS232C <=> Ethernet conversion function
<b>Ethernet Specifications</b>	Electrical characteristics: Complies with IEEE802.3 Transmission speed: 10BASE-T/100BASE-TX (Not CE compliant) Communication protocol: IP/ICMP/ARP Ethernet protocol: TCP/SMTP/HTTP/Telnet No. of TCP connections: 1
<b>Serial Interface Specifications</b>	Electrical characteristics: EIA RS232C Transmission speed: 9600 to 115200 bps Synchronization: Asynchronous Communication protocol: Full duplex Transmission control: RTS/CTS, XON/OFF, None
<b>Connection Method</b>	Ethernet interface: RJ45 Serial interface: Mini DIN 8-pin connector Cable Part No.: FC4A-KC3C
<b>Major Functions</b>	Remote maintenance: Uploading, downloading and monitoring using WindLDR via Ethernet  Web server: Configure the web server unit using Internet Explorer etc. Reading and writing PLC operands using Java applet. Web file area: 512 KB Compliant browser: Internet Explorer 6.0 or higher, Netscape Navigator 7.2  Ethernet user communication: User communication using Ethernet Message transmission: Registered outgoing message 32 message types, 63 characters maximum per message, 2 email addresses, 64 address characters maximum
<b>Optional</b>	Utility CD: Configuration file, PLC operand monitor sample programs, sample program configuration instructions, instruction manual (English/German/Spanish/Japanese/Chinese)

### Connectable Devices

#### Programmable Controllers

IDEC FC5A MicroSmart  
IDEC FC4A MicroSmart  
IDEC FC3A OpenNet Controller

#### Operator Interface

(RS232C communication with PLC through Ethernet)  
IDEC HG2F

### Dimensions

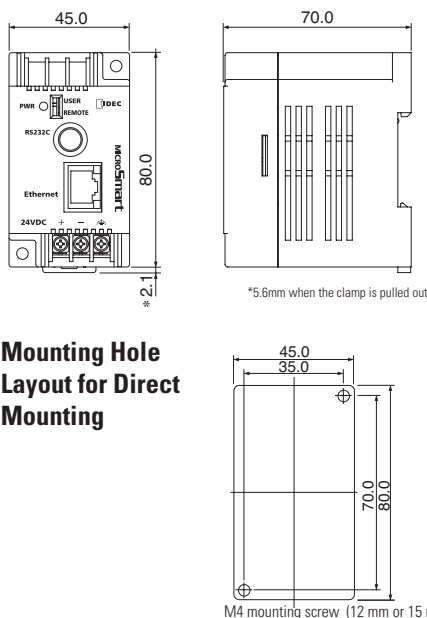

### Web Server Cable (FC4A-KC3C, Cable Length: 100 mm)

#### Cable Dimensions



#### Connector Pinout

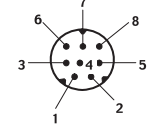

#### Cable Connection Diagram

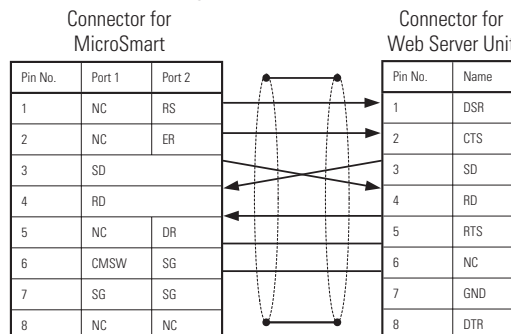

Ethernet is a registered trademark of Xerox Corporation.