

**Features**

- Fit automatic placement equipment.
- Fit Compatible with infrared and vapor phase reflow solder process.
- Pb-free.
- RoHS compliant.

**Descriptions**

- For higher packing density .
- For minature applications .
- Water clear lens .
- Chip material : AlGaInP .
- Emitting color : Red .

**Package Outline Dimensions**

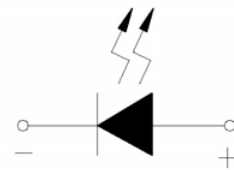
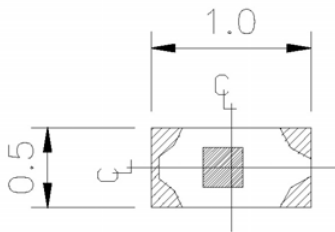

POLARITY

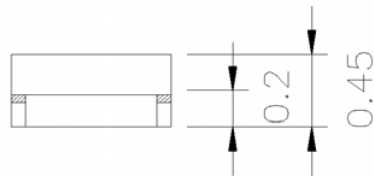

For Reflow Soldering

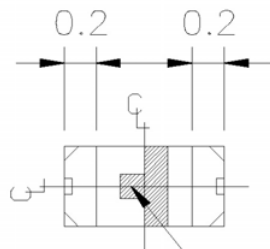

Cathode Mark

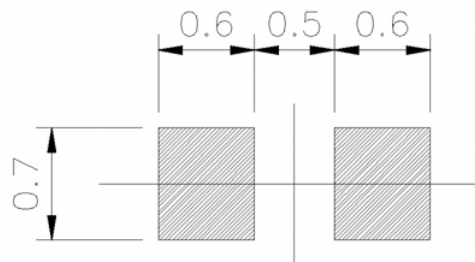

**Note:** The tolerances unless mentioned is  $\pm 0.1\text{mm}$  ,Unit = mm



**Absolute Maximum Ratings (Ta=25°C)**

Parameter	Symbol	Rating	Unit
Reverse Voltage	V <sub>R</sub>	5	V
Forward Current	I <sub>F</sub>	25	mA
Operating Temperature	T <sub>opr</sub>	-40 ~ +85	°C
Storage Temperature	T <sub>stg</sub>	-40 ~ +90	°C
Soldering Temperature	T <sub>sol</sub>	260 (for 5 second)	°C
Electrostatic Discharge (HBM)	ESD	2000	V
Power Dissipation	P <sub>d</sub>	60	mW
Peak Forward Current (Duty 1/10 @1KHz)	I <sub>FP</sub>	60	mA
Soldering Temperature	T <sub>sol</sub>	Reflow Soldering : 260 °C for 10 sec. Hand Soldering : 350 °C for 3 sec.	

**Electro-Optical Characteristics (Ta=25°C)**

Parameter	Symbol	Chip Rank	Min.	Typ.	Max.	Unit	Condition
Luminous Intensity	Iv	A2	15	36	-----	mcd	If=20mA
		A3	25	40	-----		
		A4	36	50	-----		
		A5	48	70	-----		
		A6	58	89	-----		
Viewing Angle $\theta$	2 1/2	-----	-----	120	-----	deg	
Peak Wavelength	$\lambda p$	-----	-----	632	-----	nm	
Dominant Wavelength	$\lambda d$	-----	-----	624	-----	nm	
Spectrum Radiation Bandwidth	$\Delta \lambda$	-----	-----	20	-----	nm	
Forward Voltage	V <sub>F</sub>	-----	1.7	2.0	2.4	V	
Reverse Current	I <sub>R</sub>	-----	-----	-----	10	$\mu A$	V <sub>R</sub> =5V

Specific binning requirements- please contact our home office

## Typical Electro-Optical Characteristics Curves

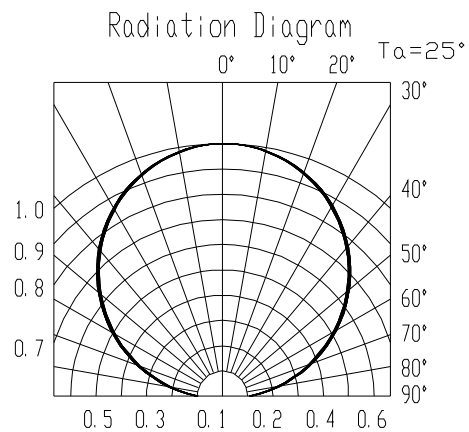
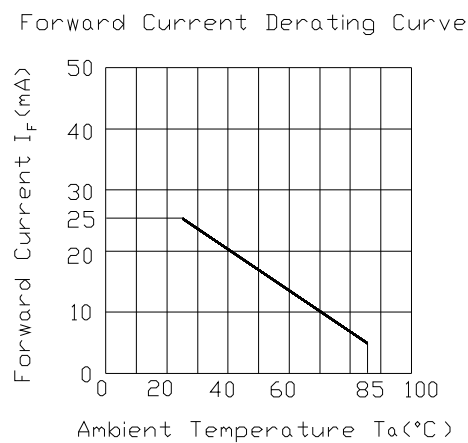
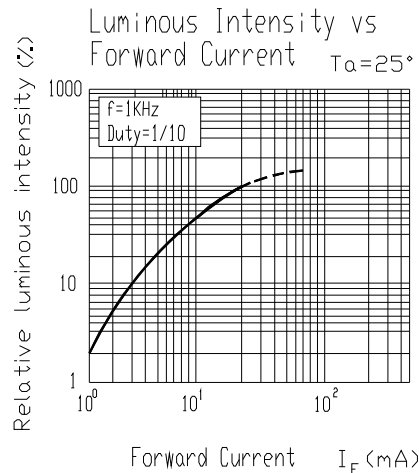
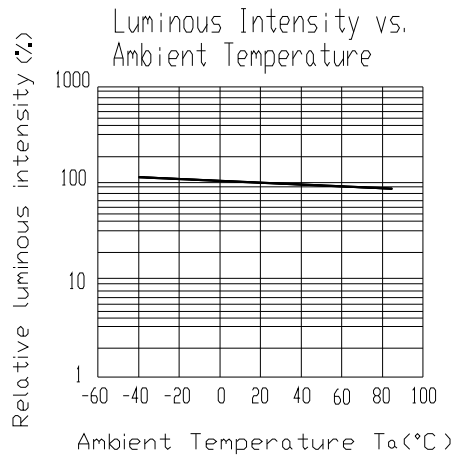
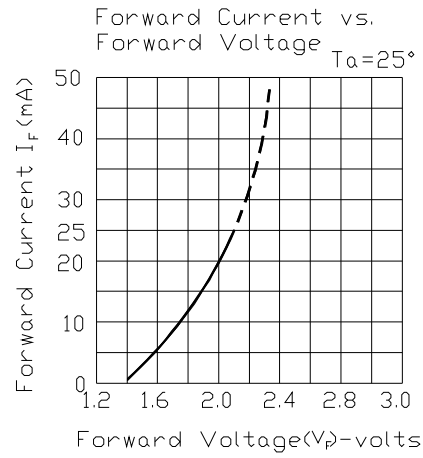
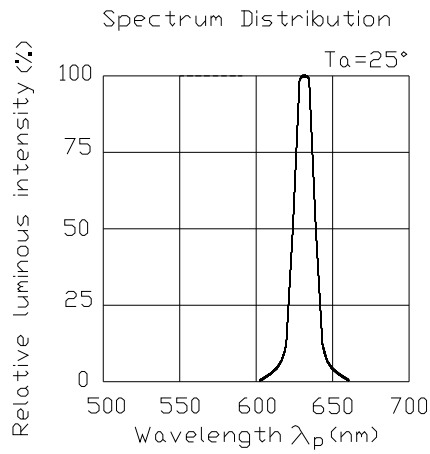

## Reel Dimensions

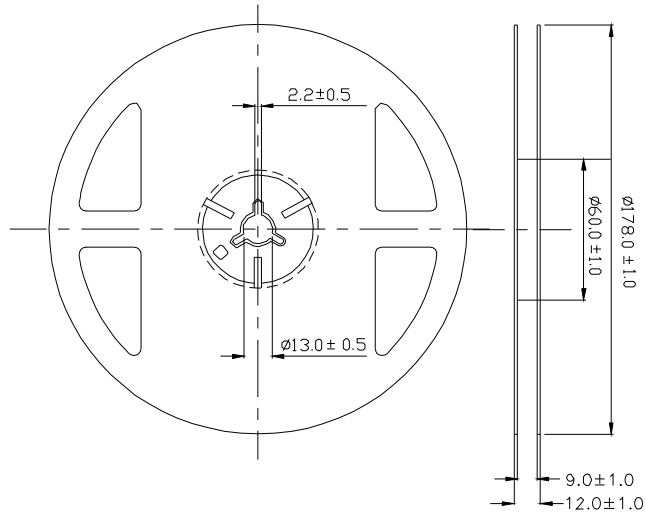

**Note:** The tolerances unless mentioned is  $\pm 0.1$ mm ,Unit = mm



## Soldering Condition

### 1. Pb-free solder temperature profile

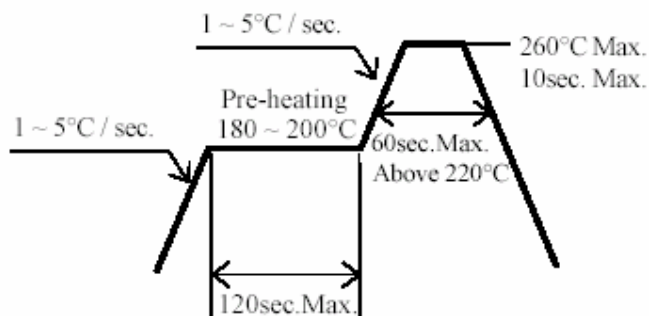

2. Reflow soldering should not be done more than two times.

3 When soldering, do not put stress on the LEDs during heating.

4 After soldering, do not warp the circuit board.

### Soldering Iron

Each terminal is to go to the tip of soldering iron temperature less than 350°C for 3 seconds within once in less than the soldering iron capacity 25W. Leave two seconds and more intervals, and do soldering of each terminal. Be careful because the damage of the product is often started at the time of the hand solder.