

CBS20048

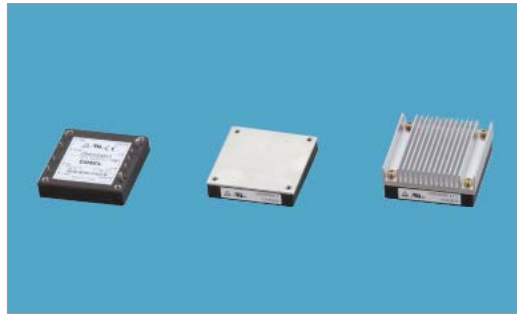

Features

- Compact DC-DC Converter, "HALF BRICK" which has been standard size for Telecommunication Market
- High efficiency
- High density
- High reliability : not built-in aluminum and tantalum electrolytic capacitor
- Built-in Remote ON/OFF
- Mounting hole (M3 tapped)
- Built-in Over Current Protection
- Built-in Over Voltage Protection
- Built-in Thermal Protection
- RoHS Compliant

Safety Agency Approvals

UL60950, C-UL (CSA60950) recognized, TUV approved

CE Markings

Low Voltage Directive

5 year warranty(refer to Instruction Manual)

Model	Input Voltage [V]	Output Wattage [W]	DC Output [V/A]
CBS200481R8	DC 36 - 76	63	1.8V 35A
CBS200482R5	DC 36 - 76	87.5	2.5V 35A
CBS2004803	DC 36 - 76	115.5	3.3V 35A
CBS2004805	DC 36 - 76	150	5V 30A
CBS2004812	DC 36 - 76	200.4	12V 16.7A
CBS2004815	DC 36 - 76	201	15V 13.4A
CBS2004824	DC 36 - 76	201.6	24V 8.4A
CBS2004828	DC 36 - 76	201.6	28V 7.2A
CBS2004848	DC 36 - 76	201.6	48V 4.2A

- ① Series name
- ② Single output
- ③ Output wattage
- ④ Input voltage
24:DC18 - 36V
48:DC36 - 76V
- ⑤ Output voltage
- ⑥ Optional
R :with Remote ON/OFF
Positive logic control
T :with Mounting hole
φ3.4 thru
:with Addition of a
Heat sink

RoHS

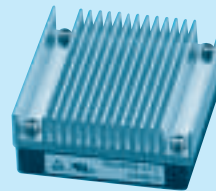
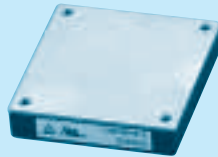
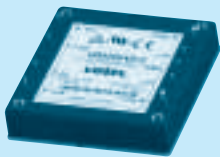

MODEL	CBS200241R8	CBS200242R5	CBS2002403	CBS2002405	CBS2002412	CBS2002415	CBS2002424	CBS2002428
MAX OUTPUT WATTAGE[W]	63.00	87.50	115.5	150.0	200.4	201.0	201.6	201.6
DC OUTPUT	1.8V 35A	2.5V 35A	3.3V 35A	5V 30A	12V 16.7A	15V 13.4A	24V 8.4A	28V 7.2A

SPECIFICATIONS

	MODEL	CBS200241R8	CBS200242R5	CBS2002403	CBS2002405	CBS2002412	CBS2002415	CBS2002424	CBS2002428	
INPUT	VOLTAGE[V]	DC18 - 36								
	CURRENT[A]	3.75typ	4.80typ	6.09typ	7.62typ	9.60typ	9.63typ	9.66typ	9.66typ	
	EFFICIENCY[%]	70typ	76typ	79typ	82typ	87typ	87typ	87typ	87typ	
OUTPUT	VOLTAGE[V]	1.8	2.5	3.3	5	12	15	24	28	
	CURRENT[A]	35	35	35	30	16.7	13.4	8.4	7.2	
	LINE REGULATION[mV]	10max	10max	10max	10max	24max	30max	48max	56max	
	LOAD REGULATION[mV]	10max	10max	10max	10max	24max	30max	48max	56max	
	RIPPLE[mVp-p]	-20 to +100°C	80max	80max	80max	80max	120max	120max	120max	120max
		-40 to -20°C	120max	120max	120max	120max	150max	150max	150max	150max
	RIPPLE NOISE[mVp-p]	-20 to +100°C	120max	120max	120max	120max	150max	150max	150max	150max
		-40 to -20°C	200max	200max	200max	200max	200max	200max	250max	250max
	TEMPERATURE REGULATION[mV]	0 to +65°C	35max	35max	35max	50max	120max	150max	240max	280max
		-40 to +100°C	66max	66max	66max	100max	240max	300max	480max	560max
DRIFT[mV]	16max	16max	16max	20max	40max	60max	90max	90max		
START-UP TIME[ms]	200max (DCIN 24V, Io=100%)									
OUTPUT VOLTAGE ADJUSTMENT RANGE[V]	Fixed (TRM pin open), adjustable by external resistor									
OUTPUT VOLTAGE SETTING[V]	1.70 - 1.98	1.98 - 2.75	1.98 - 3.63	3.0 - 5.5	7.2 - 13.2	9.0 - 16.5	14.4 - 26.4	16.8 - 30.8		
OVERCURRENT PROTECTION	Works over 105% of rating and recovers automatically									
OVERVOLTAGE PROTECTION[V]	2.16 - 2.88	3.00 - 4.00	4.00 - 5.50	5.75 - 7.00	13.80 - 16.80	17.25 - 21.00	27.60 - 33.60	32.20 - 39.20		
REMOTE SENSING	Provided									
REMOTE ON/OFF	Provided (Negative logic L : ON, H : OFF)									

MODEL	CBS200481R8	CBS200482R5	CBS2004803	CBS2004805	CBS2004812	CBS2004815	CBS2004824	CBS2004828	CBS2004848
MAX OUTPUT WATTAGE[W]	63.00	87.50	115.5	150.0	200.4	201.0	201.6	201.6	201.6
DC OUTPUT	1.8V 35A	2.5V 35A	3.3V 35A	5V 30A	12V 16.7A	15V 13.4A	24V 8.4A	28V 7.2A	48V 4.2A

SPECIFICATIONS

	MODEL	CBS200481R8	CBS200482R5	CBS2004803	CBS2004805	CBS2004812	CBS2004815	CBS2004824	CBS2004828	CBS2004848	
INPUT	VOLTAGE[V]	DC36 - 76									
	CURRENT[A]	1.88typ	2.40typ	3.01typ	3.77typ	4.74typ	4.76typ	4.77typ	4.77typ	4.77typ	
	EFFICIENCY[%]	70typ	76typ	80typ	83typ	88typ	88typ	88typ	88typ	88typ	
OUTPUT	VOLTAGE[V]	1.8	2.5	3.3	5	12	15	24	28	48	
	CURRENT[A]	35	35	35	30	16.7	13.4	8.4	7.2	4.2	
	LINE REGULATION[mV]	10max	10max	10max	10max	24max	30max	48max	56max	96max	
	LOAD REGULATION[mV]	10max	10max	10max	10max	24max	30max	48max	56max	96max	
	RIPPLE[mVp-p]	-20 to +100°C	80max	80max	80max	80max	120max	120max	120max	120max	200max
		-40 to -20°C	120max	120max	120max	120max	150max	150max	150max	150max	250max
	RIPPLE NOISE[mVp-p]	-20 to +100°C	120max	120max	120max	120max	150max	150max	150max	150max	250max
		-40 to -20°C	200max	200max	200max	200max	200max	200max	250max	250max	400max
	TEMPERATURE REGULATION[mV]	0 to +65°C	35max	35max	35max	50max	120max	150max	240max	280max	480max
		-40 to +100°C	66max	66max	66max	100max	240max	300max	480max	560max	960max
DRIFT[mV]	16max	16max	16max	20max	40max	60max	90max	90max	180max		
START-UP TIME[ms]	200max (DCIN 48V, Io=100%)										
OUTPUT VOLTAGE ADJUSTMENT RANGE[V]	Fixed (TRM pin open), adjustable by external resistor										
OUTPUT VOLTAGE SETTING[V]	1.70 - 1.98	1.98 - 2.75	1.98 - 3.63	3.0 - 5.5	7.2 - 13.2	9.0 - 16.5	14.4 - 26.4	16.8 - 30.8	43.2 - 52.8		
OVERCURRENT PROTECTION	Works over 105% of rating and recovers automatically										
OVERVOLTAGE PROTECTION[V]	2.16 - 2.88	3.00 - 4.00	4.00 - 5.50	5.75 - 7.00	13.80 - 16.80	17.25 - 21.00	27.60 - 33.60	32.20 - 39.20	55.20 - 67.20		
REMOTE SENSING	Provided										
REMOTE ON/OFF	Provided (Negative logic L : ON, H : OFF)										

GENERAL SPECIFICATIONS

ISOLATION	INPUT-OUTPUT	DC1,500V or AC1,000V 1minute, Cutoff current = 10mA, DC500V 50MΩ min(20±15°C)
	INPUT-CASE PIN, BASE PLATE	DC1,500V or AC1,000V 1minute, Cutoff current = 10mA, DC500V 50MΩ min(20±15°C)
	OUTPUT-CASE PIN, BASE PLATE	AC500V 1minute, Cutoff current = 100mA, DC500V 50MΩ min (20±15°C)
ENVIRONMENT	OPERATING TEMP.HUMID.AND ALTITUDE	-40 to +100°C (On aluminum base plate), 20 - 95%RH (Non condensing) (Refer to DERATING CURVE), 3,000m (10,000feet) max
	STORAGE TEMP.HUMID.AND ALTITUDE	-40 to +100°C, 20 - 95%RH (Non condensing), 9,000m (30,000feet) max
	VIBRATION	10 - 55Hz, 49.0m/s ² (5G), 3minutes period, 60minutes each along X, Y and Z axis
	IMPACT	196.1m/s ² (20G), 11ms, once each along X, Y and Z axis
SAFETY	AGENCY APPROVALS	UL60950-1, C-UL, EN60950-1
OTHERS	CASE SIZE/WEIGHT	57.9×12.7×61.0mm (W×H×D) / 83g max
	COOLING METHOD	Conduction cooling (e.g. heat radiation from the aluminum base plate to the attached heat sink)

- *1 At rated input(DC24V,DC48V) and rated load.
- *2 Ripple and ripple noise is measured by using measuring board with recommended capacitor Co & the film capacitor 0.1 μF.
Measured by 20MHz oscilloscope or Ripple-Noise meter (Equivalent to KEISOKU-GIKEN:RM101).
- *3 Drift is the change in DC output for an eight hour period after a half-hour warm-up at 25°C, with the input voltage held constant at the rated input/output.
- *4 When the input voltage is in the range of DC18 - 20V, DC36 - 40V, output voltage adjustment range is 60 - 105% (except for 1R8/2R5/4R).

External view

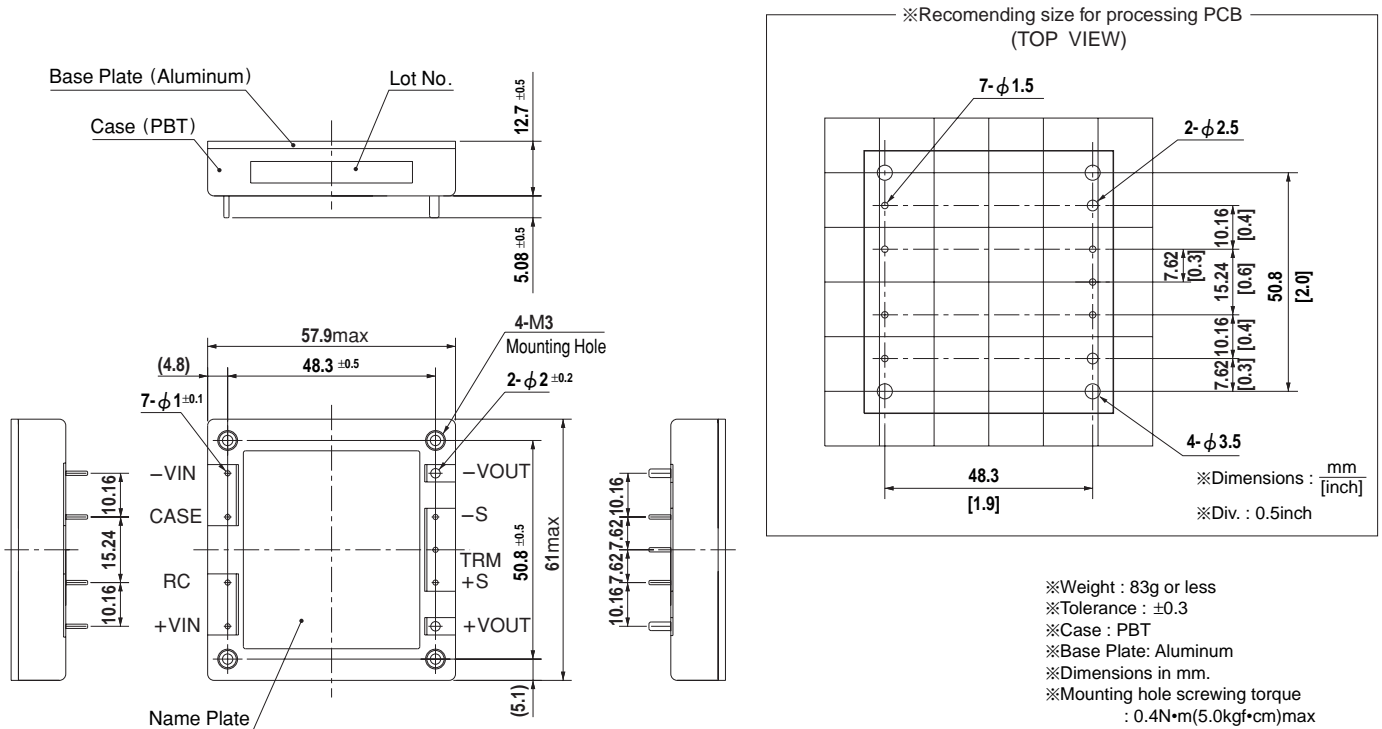

Performance data

■INPUT CURRENT CHARACTERISTICS (CBS2002428)

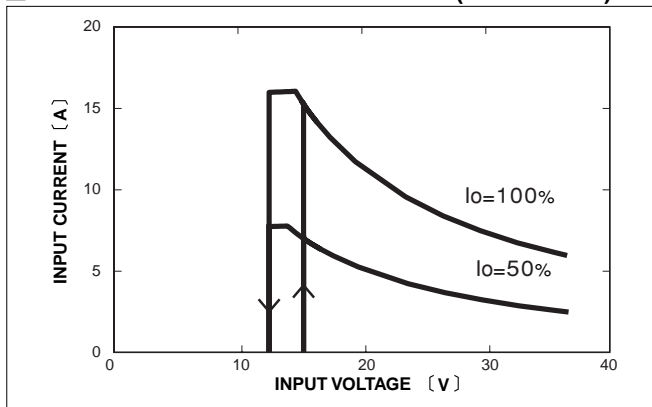

■INPUT CURRENT CHARACTERISTICS (CBS2004828)

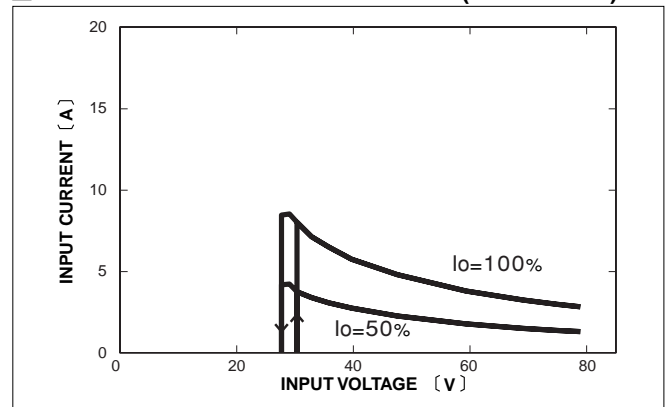

CBS