

Solid State Relays G3NE

Compact, Low-cost, SSR Switching 5 to 20 A

- Wide load voltage range: 75 to 264 VAC.
- Dedicated, compact aluminum PCB and power elements used.
- Built-in varistor effectively absorbs external surges.
- Quick-connect #110 input terminals and #250 output connections. (#187 input terminals and #250 output connections are available.)
- “-US” models certified by UL, CSA, and IEC/EN (TÜV).

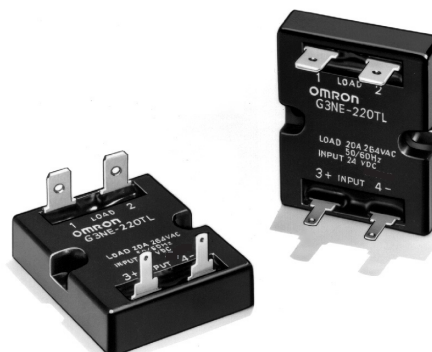

Ordering Information

To order: Select the part number and add the desired coil voltage rating. (e.g., G3NE-205T-US DC24)

Isolation	Zero cross function	Indicator	Rated output load	Rated input voltage	Model
Phototriac	Yes	No	5 A at 100 to 240 VAC (5 A at 75 to 264 VAC)	5, 12, 24 VDC	G3NE-205T-US
			10 A at 100 to 240 VAC (10 A at 75 to 264 VAC)		G3NE-210T-US
			20 A at 100 to 240 VAC (20 A at 75 to 264 VAC)		G3NE-220T-US
	No		5 A at 100 to 240 VAC (5A at 75 to 264 VAC)		G3NE-205TL-US
			10 A at 100 to 240 VAC (10 A at 75 to 264 VAC)		G3NE-210TL-US
			20 A at 100 to 240 VAC (20 A at 75 to 264 VAC)		G3NE-220TL-US

Note: When ordering #187 input terminal versions, place “-2” before “-US in the part number. (e.g., G3NE-210TL-2-US DC12)

■ Accessories (Order Separately)

Heat Sinks

The following heat sinks are thin and can be DIN-track mounted. See *Dimensions* for details.

Model	Applicable SSR
Y92B-N50	G3NE-205T(L)(-2)-US/-210T(L)(-2)-US
Y92B-N100	G3NE-220T(L)(-2)-US

Specifications

■ Ratings (at an Ambient Temperature of 25°C)

Input

Rated voltage	Operating voltage	Voltage level		Input impedance	
		Must operate	Must release	With zero cross function	Without zero cross function
5 VDC	4 to 6 VDC	4 VDC max.	1 VDC min.	250 Ω ±20%	300 Ω ±20%
12 VDC	9.6 to 14.4 VDC	9.6 VDC max.		600 Ω ±20%	800 Ω ±20%
24 VDC	19.2 to 28.8 VDC	19.2 VDC max.		1.6 k Ω ±20%	

Note: Each model has 5-VDC, 12-VDC, and 24-VDC input versions.

Output

Model	Applicable load				
	Rated load voltage	Load voltage range	Load current (See note 1)		Inrush current
			With heat sink	Without heat sink	
G3NE-205T(L)(-2)-US	100 to 240 VAC	75 to 264 VAC	0.1 to 5 A	0.1 to 5 A	60 A (60 Hz, 1 cycle)
G3NE-210T(L)(-2)-US			0.1 to 10 A (See note 2)	0.1 to 5 A	150 A (60 Hz, 1 cycle)
G3NE-220T(L)(-2)-US			0.1 to 20 A (See note 2)	0.1 to 5 A	220 A (60 Hz, 1 cycle)

Note: 1. The load current varies depending on the ambient temperature. Refer to *Load Current vs. Ambient Temperature* under *Engineering Data* for details.

2. These values apply when using a dedicated heat sink or a radiation plate of specified size.

■ Characteristics

Item	G3NE-2□□T(-2)-US	G3NE-2□□TL(-2)-US
Operate time	1/2 of load power source cycle + 1 ms max.	1 ms max.
Release time	1/2 of load power source cycle + 1 ms max.	
Output ON voltage drop	1.6 V (RMS) max.	
Leakage current	2 mA max. (at 100 VAC) 5 mA max. (at 200 VAC)	
Insulation resistance	100 M Ω min. (at 500 VDC)	
Dielectric strength	2,000 VAC, 50/60 Hz for 1 min	
Vibration resistance	Malfunction: 10 to 55, 1.5-mm double amplitude	
Shock resistance	Malfunction: 1,000 m/s ² (approx. 100G)	
Ambient temperature	Operating: -30°C to 80°C (with no icing or condensation) Storage: -30°C to 100°C (with no icing or condensation)	
Ambient humidity	Operating: 45% to 85%	
Certified standards	UL File No. E64562/CSA File No. LR35535 TÜV R9051064 (VDE0435) (EN60950)	
Weight	Approx. 37 g	

Engineering Data

Load Current vs. Ambient Temperature

G3NE-205T(L)(-2)-US

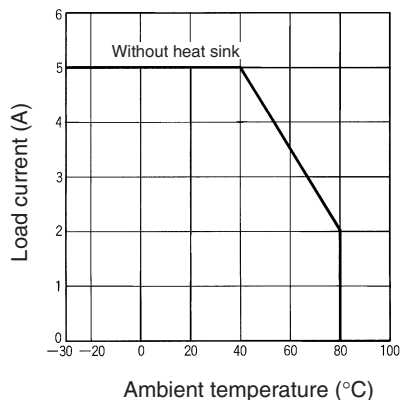

G3NE-210T(L)(-2)-US

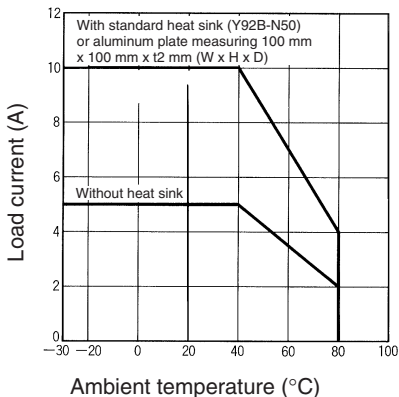

G3NE-220T(L)(-2)-US

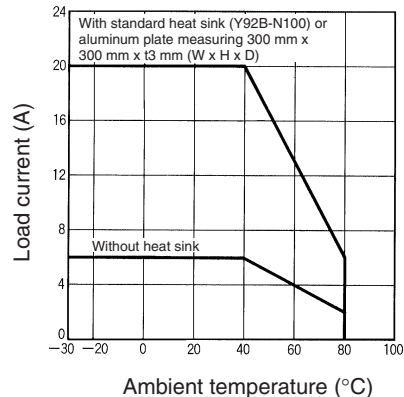

Inrush Current Resistivity

One cycle, non-repetitive (Keep the inrush current to half the rated value if it occurs repetitively.)

G3NE-205T(L)(-2)-US

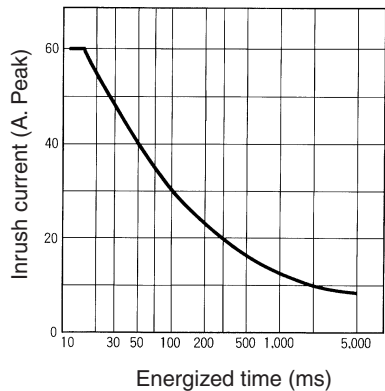

G3NE-210T(L)(-2)-US

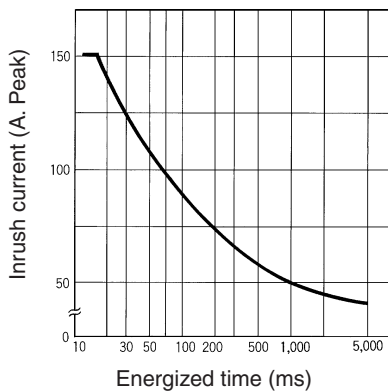

G3NE-220T(L)(-2)-US

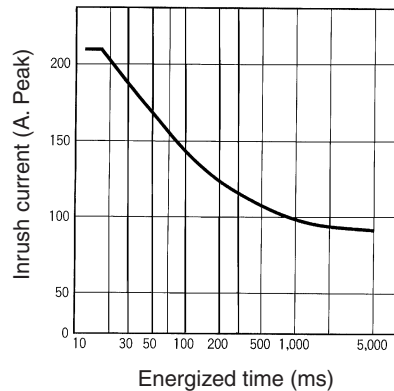

Dimensions

Note: All units are in millimeters unless otherwise indicated.

G3NE-205T(L)/210T(L)/220T(L)(-2)-US

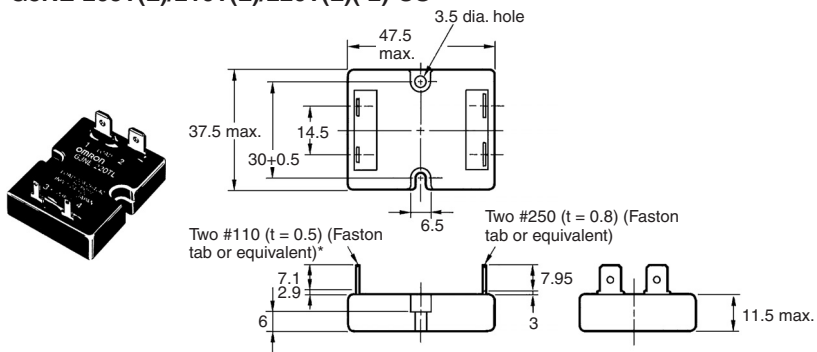

* G3NE-2□□□(L)-2-US: Two, #187 (t=0.5) (Faston tab or equivalent)

Terminal Arrangement/ Internal Connections (Top View)

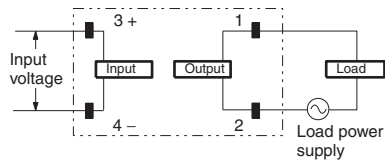

Mounting Holes

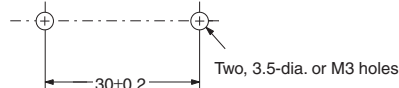

Heat Sink Y92B-N50

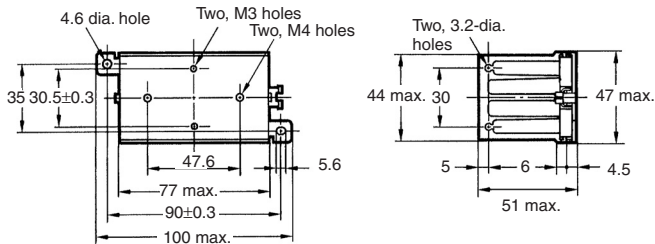

Mounting Holes

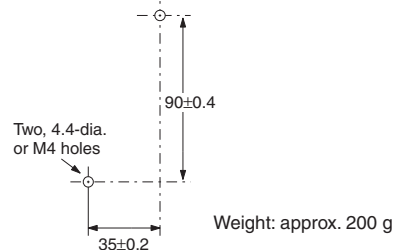

Y92B-N100

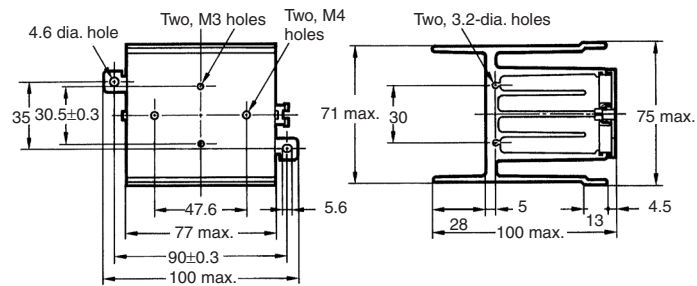

Mounting Holes

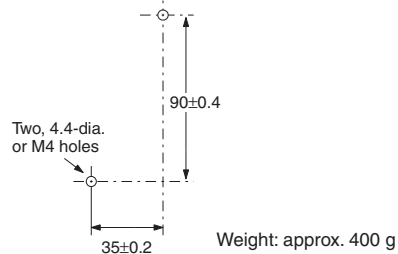

■ Approvals

UL Recognized (File No. E64562) / CSA Certified (File No. LR35535) - - Ambient Temp. = 40°C

Input voltage	SSR type	Output ratings
5, 12, 24 VDC	G3NE-205	5A resistive, 240 VAC 3A Tungsten, 240 VAC 3.2A FLA/ 19.2A LRA, 240 VAC 50/60 Hz
	G3NE-210	10A resistive, 240 VAC 7.5A Tungsten, 240 VAC 4.8A FLA/ 28.8A LRA, 240 VAC 50/60 Hz
	G3NE-210	5A resistive, 240 VAC 5A Tungsten, 240 VAC 3A FLA/ 18A LRA, 240 VAC 50/60 Hz
	G3NE-220	20A resistive, 240 VAC 11A Tungsten, 240 VAC 11.1A FLA/ 66.6A LRA, 240 VAC 50/60 Hz
	G3NE-220	6A resistive, 240 VAC 6A Tungsten, 240 VAC 3.3A FLA/ 19.8A LRA, 240 VAC 50/60 Hz

Precautions

Do not apply excessive force to the terminals. Exercise care when pulling or inserting the terminal clips.

When attaching a heat sink to the G3NE, apply heat-conductive grease on the heat sink. Tighten the mounting screws of the heat sink with a torque of 0.59 to 0.98 N•m

Thermal Resistance Rth (Back of Junction SSR)

Model	Thermal resistance (°C/W)
G3NE-205T (L)	2.72
G3NE-210T (L)	2.12
G3NE-220T (L)	2.22

EMC Directive Compliance

The G3NE complies with EMC Directives under the following conditions ("US" models only).

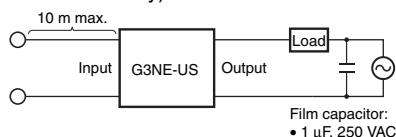

- Connect a film capacitor to the load power supply.
- The input cable must be less than 10 m.

ALL DIMENSIONS SHOWN ARE IN MILLIMETERS.

To convert millimeters into inches, multiply by 0.03937. To convert grams into ounces, multiply by 0.03527.

MEMO

A large grid of dashed lines for taking notes, consisting of 20 columns and 30 rows of small squares.

Read and Understand This Catalog

Please read and understand this catalog before purchasing the products. Please consult your OMRON representative if you have any questions or comments.

Warranty and Limitations of Liability

WARRANTY

OMRON's exclusive warranty is that the products are free from defects in materials and workmanship for a period of one year (or other period if specified) from date of sale by OMRON.

OMRON MAKES NO WARRANTY OR REPRESENTATION, EXPRESS OR IMPLIED, REGARDING NON-INFRINGEMENT, MERCHANTABILITY, OR FITNESS FOR PARTICULAR PURPOSE OF THE PRODUCTS. ANY BUYER OR USER ACKNOWLEDGES THAT THE BUYER OR USER ALONE HAS DETERMINED THAT THE PRODUCTS WILL SUITABLY MEET THE REQUIREMENTS OF THEIR INTENDED USE. OMRON DISCLAIMS ALL OTHER WARRANTIES, EXPRESS OR IMPLIED.

LIMITATIONS OF LIABILITY

OMRON SHALL NOT BE RESPONSIBLE FOR SPECIAL, INDIRECT, OR CONSEQUENTIAL DAMAGES, LOSS OF PROFITS OR COMMERCIAL LOSS IN ANY WAY CONNECTED WITH THE PRODUCTS, WHETHER SUCH CLAIM IS BASED ON CONTRACT, WARRANTY, NEGLIGENCE, OR STRICT LIABILITY.

In no event shall the responsibility of OMRON for any act exceed the individual price of the product on which liability is asserted.

IN NO EVENT SHALL OMRON BE RESPONSIBLE FOR WARRANTY, REPAIR, OR OTHER CLAIMS REGARDING THE PRODUCTS UNLESS OMRON'S ANALYSIS CONFIRMS THAT THE PRODUCTS WERE PROPERLY HANDLED, STORED, INSTALLED, AND MAINTAINED AND NOT SUBJECT TO CONTAMINATION, ABUSE, MISUSE, OR INAPPROPRIATE MODIFICATION OR REPAIR.

Application Considerations

SUITABILITY FOR USE

OMRON shall not be responsible for conformity with any standards, codes, or regulations that apply to the combination of products in the customer's application or use of the products.

At the customer's request, OMRON will provide applicable third party certification documents identifying ratings and limitations of use that apply to the products. This information by itself is not sufficient for a complete determination of the suitability of the products in combination with the end product, machine, system, or other application or use.

The following are some examples of applications for which particular attention must be given. This is not intended to be an exhaustive list of all possible uses of the products, nor is it intended to imply that the uses listed may be suitable for the products:

- Outdoor use, uses involving potential chemical contamination or electrical interference, or conditions or uses not described in this catalog.
- Nuclear energy control systems, combustion systems, railroad systems, aviation systems, medical equipment, amusement machines, vehicles, safety equipment, and installations subject to separate industry or government regulations.
- Systems, machines, and equipment that could present a risk to life or property.

Please know and observe all prohibitions of use applicable to the products.

NEVER USE THE PRODUCTS FOR AN APPLICATION INVOLVING SERIOUS RISK TO LIFE OR PROPERTY WITHOUT ENSURING THAT THE SYSTEM AS A WHOLE HAS BEEN DESIGNED TO ADDRESS THE RISKS, AND THAT THE OMRON PRODUCTS ARE PROPERLY RATED AND INSTALLED FOR THE INTENDED USE WITHIN THE OVERALL EQUIPMENT OR SYSTEM.

PROGRAMMABLE PRODUCTS

OMRON shall not be responsible for the user's programming of a programmable product, or any consequence thereof.

Disclaimers

CHANGE IN SPECIFICATIONS

Product specifications and accessories may be changed at any time based on improvements and other reasons.

It is our practice to change model numbers when published ratings or features are changed, or when significant construction changes are made. However, some specifications of the products may be changed without any notice. When in doubt, special model numbers may be assigned to fix or establish key specifications for your application on your request. Please consult with your OMRON representative at any time to confirm actual specifications of purchased products.

DIMENSIONS AND WEIGHTS

Dimensions and weights are nominal and are not to be used for manufacturing purposes, even when tolerances are shown.

PERFORMANCE DATA

Performance data given in this catalog is provided as a guide for the user in determining suitability and does not constitute a warranty. It may represent the result of OMRON's test conditions, and the users must correlate it to actual application requirements. Actual performance is subject to the OMRON Warranty and Limitations of Liability.

ERRORS AND OMISSIONS

The information in this document has been carefully checked and is believed to be accurate; however, no responsibility is assumed for clerical, typographical, or proofreading errors, or omissions.



OMRON ELECTRONICS LLC • THE AMERICAS HEADQUARTERS • Schaumburg, IL USA • 847.843.7900 • 800.556.6766 • www.omron247.com

OMRON CANADA, INC. • HEAD OFFICE

Toronto, ON, Canada • 416.286.6465 • 866.986.6766
www.omron247.com

OMRON ELETRÔNICA DO BRASIL LTDA • HEAD OFFICE

São Paulo, SP, Brasil • 55.11.2101.6300 • www.omron.com.br

OMRON ELECTRONICS MEXICO SA DE CV • HEAD OFFICE

Apodaca, N.L. • 52.811.156.99.10 • 001.800.556.6766 • mela@omron.com

OMRON ARGENTINA • SALES OFFICE

Cono Sur • 54.11.4783.5300

OMRON CHILE • SALES OFFICE

Santiago • 56.9.9917.3920

OTHER OMRON LATIN AMERICA SALES

54.11.4783.5300

OMRON EUROPE B.V. Wegalaan 67-69, NL-2132 JD, Hoofddorp, The Netherlands. Tel: +31 (0) 23 568 13 00 Fax: +31 (0) 23 568 13 88 www.industrial.omron.eu