

## High Efficiency Blue LED, $\varnothing$ 5 mm Tinted Diffused Package

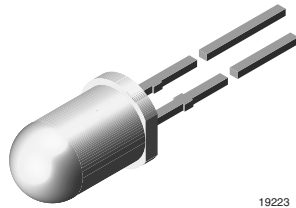

19223

### DESCRIPTION

This device has been redesigned in 1998 replacing SiC by GaN technology to meet the increasing demand for high efficiency blue LEDs.

It is housed in a 5 mm tinted diffused plastic package. All packing units are categorized in luminous intensity groups. That allows users to assemble LEDs with uniform appearance.

### FEATURES

- GaN on SiC technology
- Standard  $\varnothing$  5 mm T-1 $\frac{3}{4}$  package
- Small mechanical tolerances
- Wide viewing angle
- Very high intensity
- Luminous intensity categorized
- ESD class 1
- Lead (Pb)-free device

### APPLICATIONS

- Status lights
- OFF/ON indicator
- Background illumination
- Readout lights
- Maintenance lights
- Legend light

### PRODUCT GROUP AND PACKAGE DATA

- Product group: LED
- Package: 5 mm
- Product series: standard
- Angle of half intensity:  $\pm 30^\circ$

PARTS TABLE		
PART	COLOR, LUMINOUS INTENSITY	TECHNOLOGY
TLHB5400	Blue, $I_V > 6.3$ mcd	GaN on SiC
TLHB5401	Blue, $I_V = (10 \text{ to } 32)$ mcd	GaN on SiC

ABSOLUTE MAXIMUM RATINGS <sup>1)</sup> TLHB540.				
PARAMETER	TEST CONDITION	SYMBOL	VALUE	UNIT
Reverse voltage		$V_R$	5	V
DC Forward current	$T_{amb} \leq 65^\circ\text{C}$	$I_F$	20	mA
Surge forward current	$t_p \leq 10 \mu\text{s}$	$I_{FSM}$	0.1	A
Power dissipation	$T_{amb} \leq 65^\circ\text{C}$	$P_V$	100	mW
Junction temperature		$T_j$	100	$^\circ\text{C}$
Operating temperature range		$T_{amb}$	- 40 to + 100	$^\circ\text{C}$
Storage temperature range		$T_{stg}$	- 40 to + 100	$^\circ\text{C}$
Soldering temperature	$t \leq 5$ s, 2 mm from body	$T_{sd}$	260	$^\circ\text{C}$
Thermal resistance junction/ambient		$R_{thJA}$	350	K/W

Note:

<sup>1)</sup>  $T_{amb} = 25^\circ\text{C}$ , unless otherwise specified

OPTICAL AND ELECTRICAL CHARACTERISTICS <sup>1)</sup> TLHB540., BLUE							
PARAMETER	TEST CONDITION	PART	SYMBOL	MIN	TYP.	MAX	UNIT
Luminous intensity <sup>2)</sup>	$I_F = 20 \text{ mA}$	TLHB5400	$I_V$	6.3	15		mcd
		TLHB5401	$I_V$	10		32	mcd
Dominant wavelength	$I_F = 10 \text{ mA}$		$\lambda_d$		466		nm
Peak wavelength	$I_F = 10 \text{ mA}$		$\lambda_p$		428		nm
Angle of half intensity	$I_F = 10 \text{ mA}$		$\phi$		$\pm 30$		deg
Forward voltage	$I_F = 20 \text{ mA}$		$V_F$		3.9	4.5	V
Reverse voltage	$I_R = 10 \mu\text{A}$		$V_R$	5			V

Note:

1)  $T_{amb} = 25 \text{ }^\circ\text{C}$  unless otherwise specified

2) in one packing unit  $I_{Vmin}/I_{Vmax} \leq 0.5$

## TYPICAL CHARACTERISTICS

$T_{amb} = 25 \text{ }^\circ\text{C}$ , unless otherwise specified

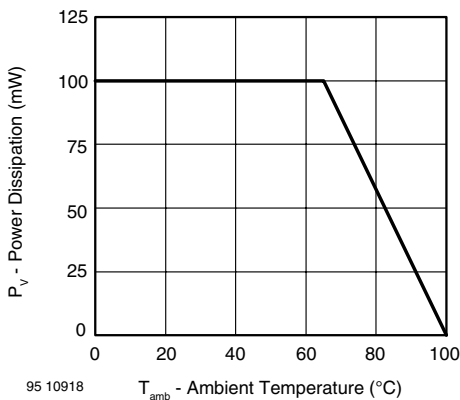

Figure 1. Power Dissipation vs. Ambient Temperature

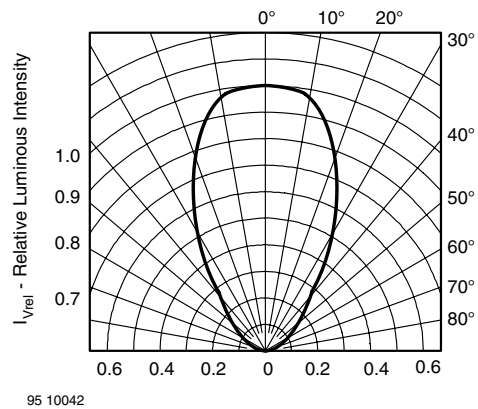

Figure 3. Rel. Luminous Intensity vs. Angular Displacement

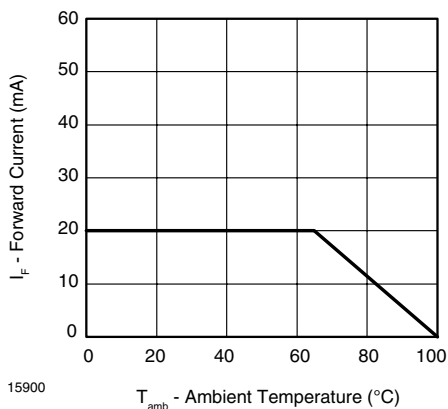

Figure 2. Forward Current vs. Ambient Temperature

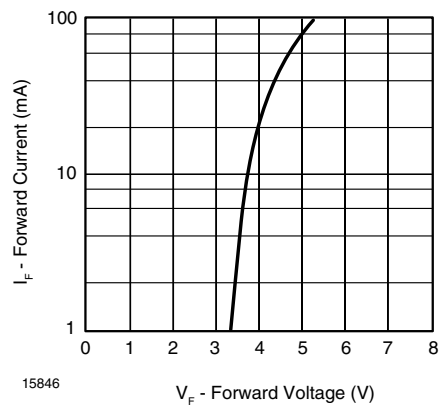

Figure 4. Forward Current vs. Forward Voltage

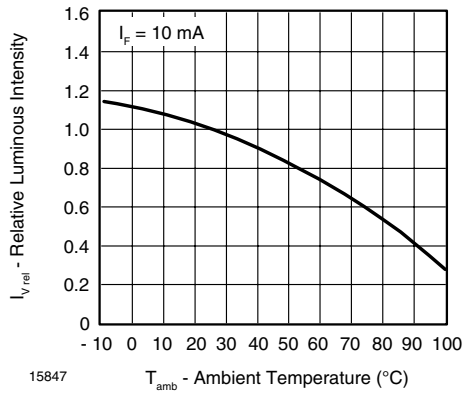

Figure 5. Rel. Luminous Flux vs. Ambient Temperature

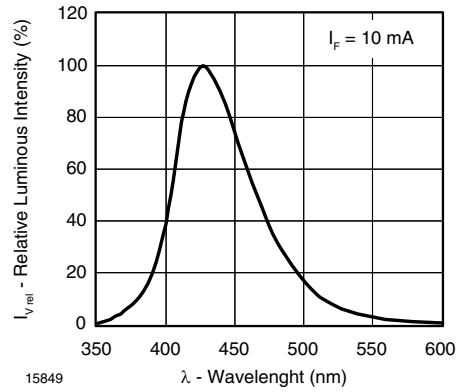

Figure 7. Relative Intensity vs. Wavelength

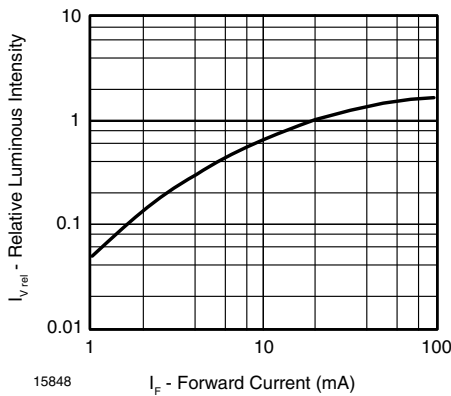
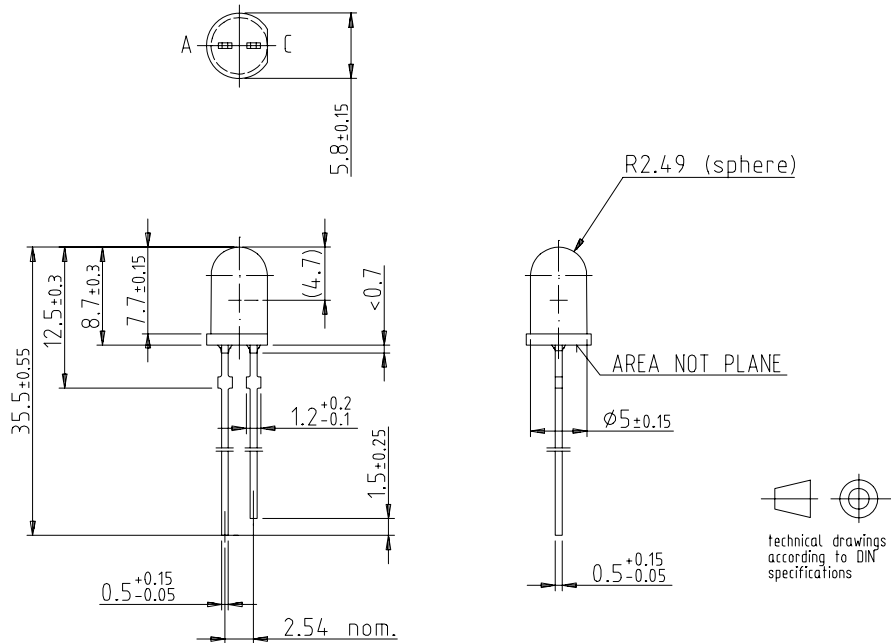

Figure 6. Relative Luminous Flux vs. Forward Current

**PACKAGE DIMENSIONS** in millimeters



95 10916