

INTERNATIONAL RECTIFIER 

2N681 & 2N5204 SERIES

25 and 35 Amp RMS SCRs

Major Ratings and Characteristics

	2N681-92	2N5204-07	Units
$I_T(\text{RMS})$	25	35	A
$I_T(\text{AV})$	16*	22*	A
@ T_C	-65 to 65*	-40 to 40	°C
I_{TSM}			
@ 50 Hz	145	285	A
@ 60 Hz	150*	300*	
i_2t			A ² s
@ 50 Hz	103	410	
@ 60 Hz	94	375	
I_{GT}	40	40	mA
dv/dt	—	100*	V/ μ s
di/dt	75–100	100	A/ μ s
T_J	-65 to 125*	-40 to 125*	°C
V_{RRM}, V_{DRM} range	25–800	600–1200	V

*JEDEC registered value.

Description/Features

- General purpose stud mounted
- Broad forward and reverse voltage range – through 1200 volts
- Can be supplied to meet stringent military, aerospace and other high-reliability requirements

CASE STYLE AND DIMENSIONS

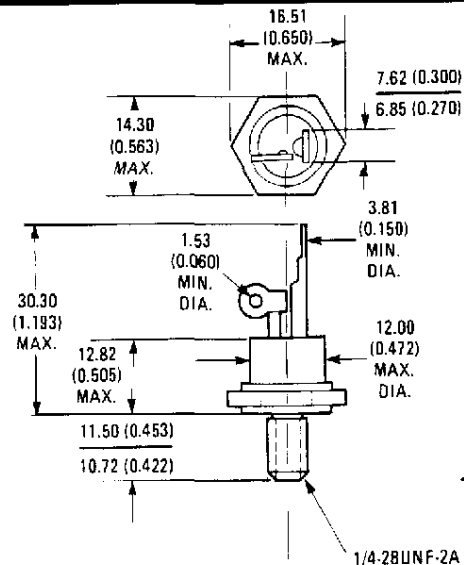
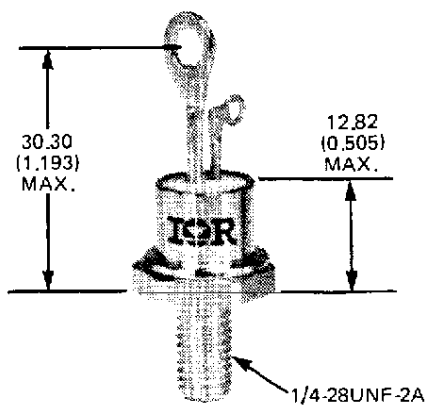

Conforms to JEDEC Outline TO-208AA (TO-48)
Dimensions in Millimeters and (Inches)

VOLTAGE RATINGS (Applied gate voltage zero or negative)

Part Numbers	V_{RRM}, V_{DRM} - Max. Repetitive Peak Reverse and Off-State Voltage (V)	V_{RSM} Max. Non Repetitive Peak Reverse Voltage $t_p < 5$ ms (V)
	$T_J = -65^{\circ}\text{C}$ to 125°C	$T_J = -65^{\circ}\text{C}$ to 125°C
2N681	25*	35*
2N682	50*	75*
2N683	100*	150*
2N685	200*	300*
2N687	300*	400*
2N688	400*	500*
2N689	500*	600*
2N690	600*	720*
2N691	700*	840*
2N692	800*	960*
	$T_J = -40^{\circ}\text{C}$ to 125°C	$T_J = -40^{\circ}\text{C}$ to 125°C
2N5204	600	720
2N5205	800	960
2N5206	1000	1200
2N5207	1200	1440

ELECTRICAL SPECIFICATIONS

	2N681-92	2N5204-07	Units	Conditions
ON-STATE				
$I_T(\text{RMS})$ Max. RMS on-state current	25	35	A	
$I_T(\text{AV})$ Max. average on-state current	16*	22*	A	180° half sine wave conduction
@ $T_C =$	-65 to 65*	-40 to 40*	°C	
I_{TSM} Max. peak one cycle, non-repetitive surge current	145	285	A	50 Hz half cycle sine wave or 6 ms rectangular pulse
	150*	300*		60 Hz half cycle sine wave or 5 ms rectangular pulse
	170	340		50 Hz half cycle sine wave or 6 ms rectangular pulse
	180	355		60 Hz half cycle sine wave or 5 ms rectangular pulse
I^2t Max. I^2t capability, for fusing	103	410	A^2s	$t = 10$ ms Rated V_{RRM} applied following surge,
	94	375		$t = 8.3$ ms initial $T_J = 125^{\circ}\text{C}$
I^2t Max. I^2t capability, for individual device fusing	145	580	A^2s	$t = 10$ ms $V_{RRM} = 0$ following surge,
	135	530		$t = 8.3$ ms initial $T_J = 125^{\circ}\text{C}$.
$I^2\sqrt{t}$ Max. $I^2\sqrt{t}$ capability, for individual device fusing (1)	1450	5800	$A^2\sqrt{s}$	$t = 0.1$ to 10 ms initial $T_J \leq 125^{\circ}\text{C}$ V_{RRM} following surge = 0.
V_{TM} Max. peak on-state voltage	2*	2.3*	V	$T_J = 25^{\circ}\text{C}$, $I_T(\text{AV}) = 16\text{A}$ (50A peak) 2N681, $I_T(\text{AV}) = 22\text{A}$ (70A peak) 2N5204
I_H Max. holding current	20 @ 25°C †	200* @ -40°C	mA	Anode supply = 24V, initial $I_T = 1.0\text{A}$.
BLOCKING				
dv/dt Min. critical rate-of-rise of off-state voltage	100†	100*	V/ μs	$T_J = 125^{\circ}\text{C}$. Exponential to 100% rated V_{DRM}
	250†	250		$T_J = 125^{\circ}\text{C}$. Exponential to 67% rated V_{DRM}

*JEDEC Registered value.

(1) I^2t for time $t_x = I^2\sqrt{t} \cdot \sqrt{t_x}$.

† Typical

ELECTRICAL SPECIFICATIONS (Continued)

		2N681-92	2N5204-07	Units	Conditions		
BLOCKING (Continued)							
$I_{R(-)}$ & $I_{D(-)}$ Max. reverse and off-state current V_{RRM} & $V_{DRM} = 5V$	$I_{R(AV)}$ & $I_{D(AV)}$ (Average Values)	I_{RM} & I_{DM} (Peak Values)	mA	$T_J = 125^{\circ}C$, gate open circuited.	25 to 150V	6.5*	—
					200 & 250V	6.0*	—
					300V	5.0*	—
					400V	4.0*	—
					500V	3.0*	—
					600V	2.5*	3.3*
					700V	2.25*	—
					800V	2.0*	2.5*
					1000V	—	2.0*
					1200V	—	1.7*
SWITCHING							
t_d	Typical delay time	1	1	μs	$T_C = 25^{\circ}C$, $V_{DM} =$ rated V_{DRM} , $I_{TM} = 10A$ dc resistive circuit. Gate pulse: 10V, 40 Ω source, $t_p = 6 \mu s$, $t_r = 0.1 \mu s$.		
di/dt	Max. non-repetitive rate of rise of turned-on current $V_{DM} = 25$ to 600V	100	—	A/ μs	$T_C = 125^{\circ}C$, $V_{DM} =$ rated V_{DRM} , $I_{TM} = 2 \times di/dt$. Gate pulse: 20V, 15 Ω , $t_p = 6 \mu s$, $t_r = 0.1 \mu s$ max. Per JEDEC standard RS-397, 5.2.2.6.		
		= 700 to 800V	75			—	
		—	100		$T_C = 125^{\circ}C$, $V_{DM} = 600V$, $I_{TM} = 200A$ @ 400 Hz, max., Gate pulse: 20V, 15 Ω , $t_p = 6 \mu s$, $t_r = 0.1 \mu s$ max. Per JEDEC standard RS-397, 5.2.2.6.		
TRIGGERING							
P_{GM}	Max. peak gate power	5*	60*	W	$t_p \leq 5$ ms for 2N681 series; $t_p \leq 500 \mu s$ for 2N5204 series..		
$P_{G(AV)}$	Max. average gate power	0.5*	0.5*	W			
$+I_{GM}$	Max. peak positive gate current	2*	2	A			
$+V_{GM}$	Max. peak positive gate voltage	10*	—	V			
$-V_{GM}$	Max. peak negative gate voltage	5*	5*	V			
I_{GT}	Max. required DC gate current to trigger	80*	80*	mA	$T_C =$ min. rated value. Max. required gate trigger current is the lowest value which will trigger all units with +6V anode-to-cathode.		
		40	40		$T_C = 25^{\circ}C$		
		18.5	20		$T_C = 125^{\circ}C$		
	Typical DC gate current to trigger	30	30	$T_C = 25^{\circ}C$ +6V anode-to-cathode			
V_{GT}	Max. required DC gate voltage to trigger	3*	3*	V	$T_C = -65^{\circ}C$. Max. required gate trigger voltage is the lowest value which will trigger all units with +6V anode-to-cathode.		
		2	2		$T_C = 25^{\circ}C$		
	Typical DC gate voltage to trigger	1.5	1.5	$T_C = 25^{\circ}C$ +6V anode-to-cathode			
V_{GD}	Max. DC gate voltage not to trigger	0.25*	0.25*	V	$T_C = 125^{\circ}C$. Max. gate voltage not to trigger is the maximum value which will not trigger any unit with rated V_{DRM} anode-to-cathode.		

THERMAL-MECHANICAL SPECIFICATIONS

		2N681-92	2N5204-07	Units	Conditions		
T_J	Operating junction temperature range	-65° to 125°	-40° to 125°	°C			
T_{stg}	Storage temperature range	-65° to 125°	-40° to 125°	°C			
R_{thJC}	Max. internal thermal resistance, junction to case	1.5	1.5*	deg. C/W	DC operation		
R_{thCS}	Thermal resistance, case to sink	0.35	0.35	deg. C/W	Mounting surface smooth, flat and greased.		
Mounting torque to nut $\pm 10\%$		20.(27.5)		lbf · in.	Lubricated threads (non-lubricated threads).		
		0.23(.32)		kgf · m			
		2.3(3.1)		N·m			
		to device		25		lbf · in.	Lubricated threads.
				0.29		kgf · m	
				2.8		N·m	
wt	Approximate weight	14(0.49)	14 (0.5)	g (oz.)			
Case Style		TO-208AA (TO-48)					

*JEDEC Registered value.

2N681 Series

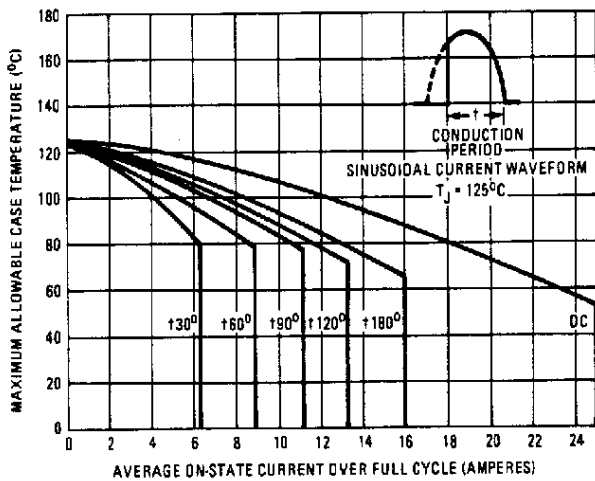

Fig. 1 – Maximum Allowable Case Temperature Vs. Average On-State Current, 2N681 Series

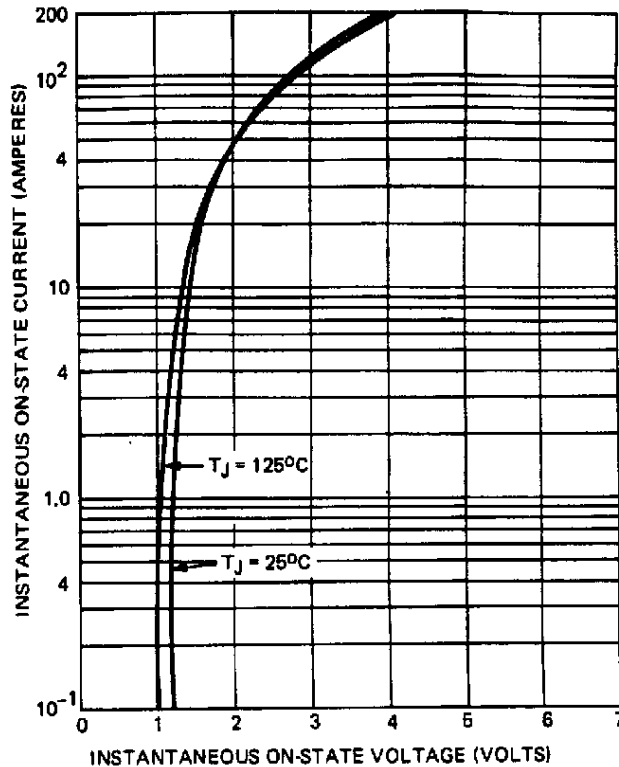

Fig. 2 – Maximum On-State Voltage Vs. Current, 2N681 Series

2N681 Series

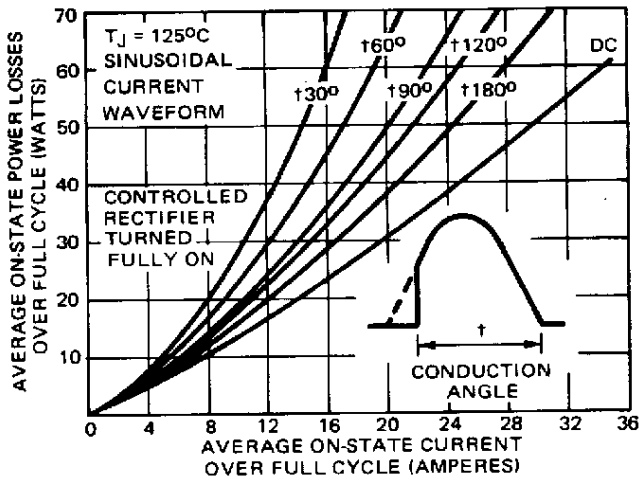

Fig. 3 – Maximum Low Level On-State Power Loss Vs. Current (Sinusoidal Current Waveform), 2N681 Series

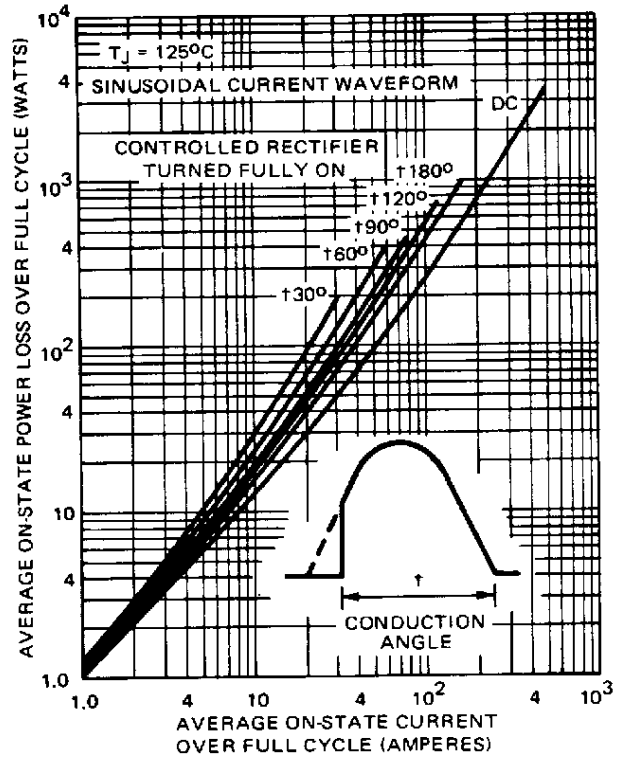

Fig. 4 – Maximum High Level On-State Power Loss Vs. Current (Sinusoidal Current Waveform), 2N681 Series

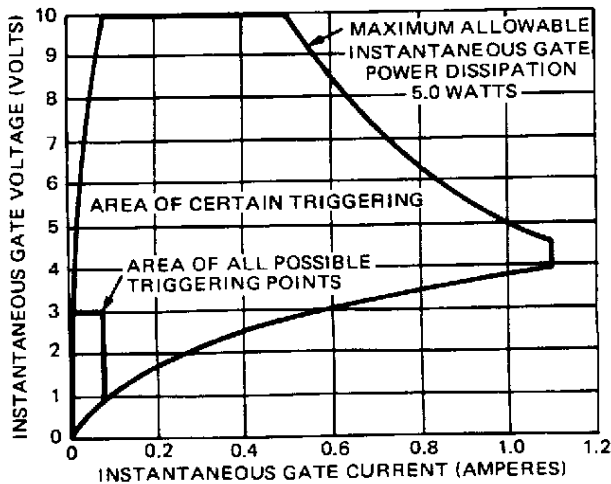

Fig. 5 – Gate Characteristics, 2N681 Series

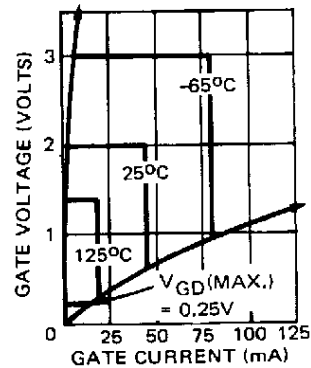

Fig. 5A – Area of All Possible Triggering Points Vs. Temperature 2N681 Series

2N681 Series

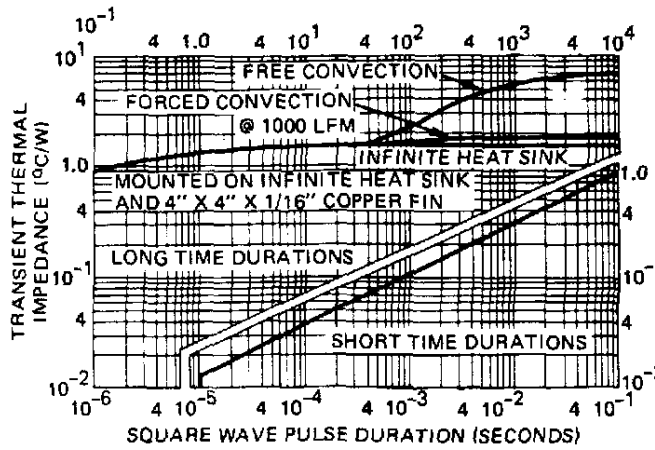

Fig. 6 - Maximum Transient Thermal Impedance, Junction to Case, Vs. Pulse Duration, 2N681 Series

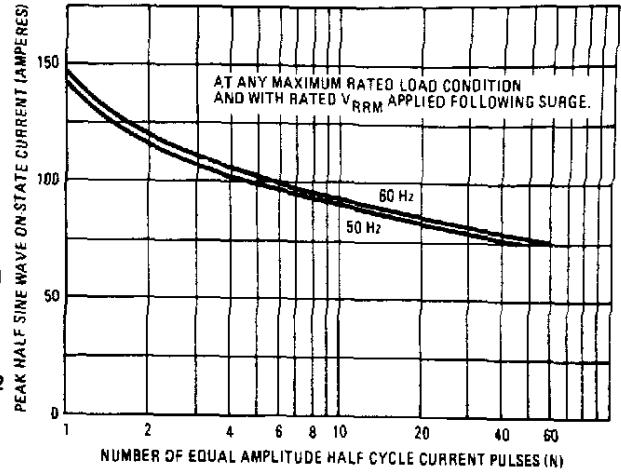

Fig. 7 - Maximum Non-Repetitive Surge Current, Vs. Number of Current Pulses, 2N681 Series

2N5204 Series

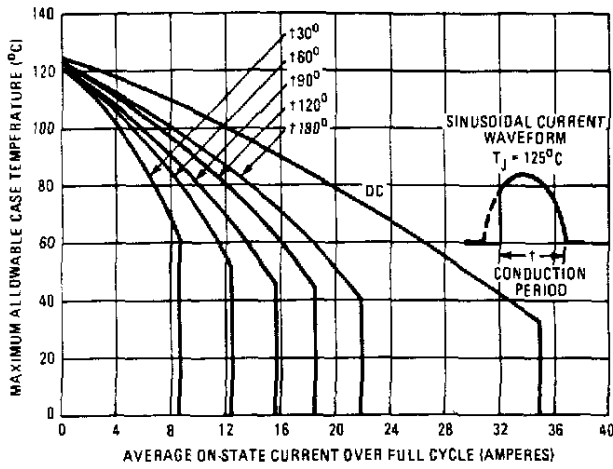

Fig. 8 - Maximum Allowable Case Temperature Vs. Average On-State Current (Sinusoidal Current Waveform), 2N5204 Series

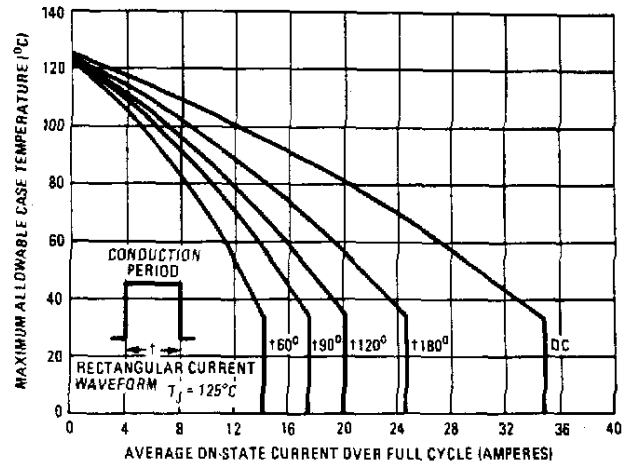

Fig. 9 - Maximum Allowable Case Temperature Vs. Average On-State Current (Rectangular Current Waveform), 2N5204 Series

2N5204 Series

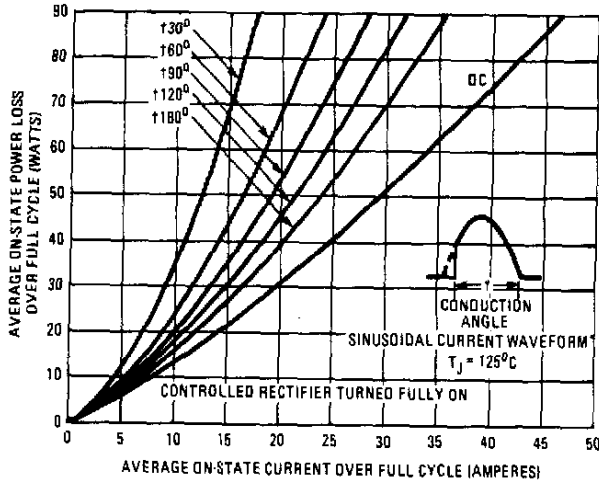

Fig. 10 – Maximum Low-Level On-State Power Loss Vs. Average On-State Current (Sinusoidal Current Waveform), 2N5204 Series

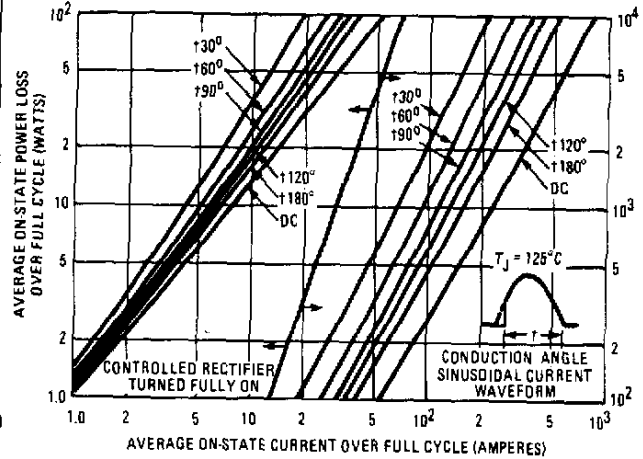

Fig. 11 – Maximum High-Level On-State Power Loss Vs. Average On-State Current (Sinusoidal Current Waveform), 2N5204 Series

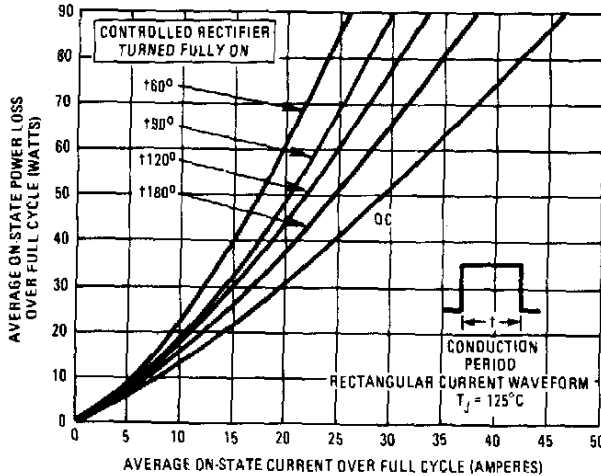

Fig. 12 – Maximum Low-Level On-State Power Loss Vs. Average On-State Current (Rectangular Current Waveform), 2N5204 Series

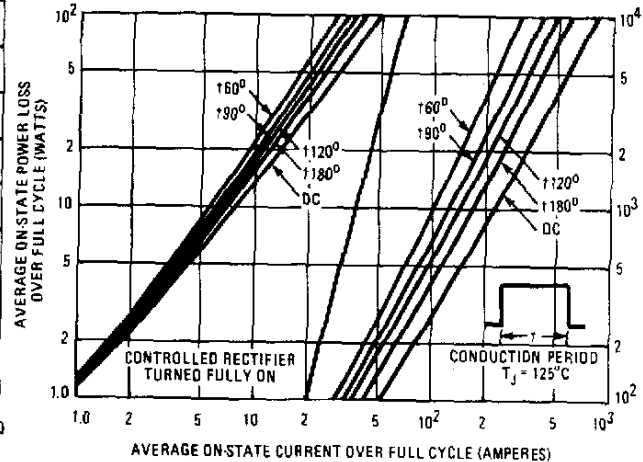

Fig. 13 – Maximum High-Level On-State Power Loss Vs. Average On-State Current (Rectangular Current Waveform), 2N5204 Series

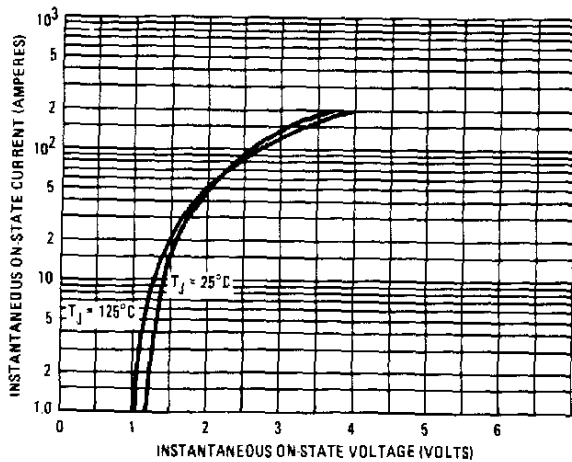

Fig. 14 – Maximum Instantaneous On-State Voltage Vs. Instantaneous On-State Current, 2N5204 Series

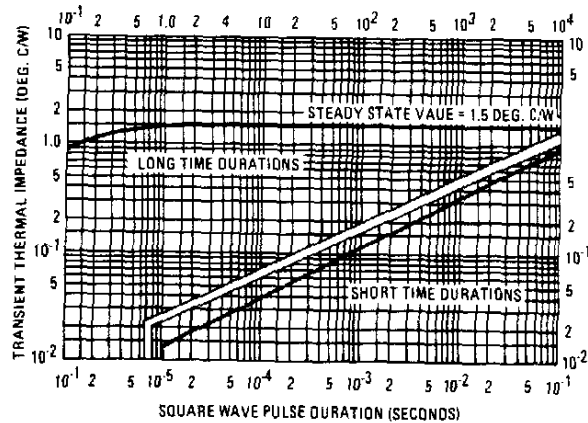

Fig. 15 – Maximum Transient Thermal Resistance, Junction to Case, Vs. Pulse Duration, 2N5204 Series

This datasheet has been download from:

www.datasheetcatalog.com

Datasheets for electronics components.