

INTRODUCTION

Wamco **F-LED 225S** is an LED illumination system for front-lit or back-lit channel letter signage as well as indoor and outdoor decorative applications. **F-LED 225S** is typically utilized in slim size channel letters (70mm~90mm depth) illumination. **F-LED 225S** provides many advantages including brilliant white light output, significant energy savings and reduced maintenance costs.

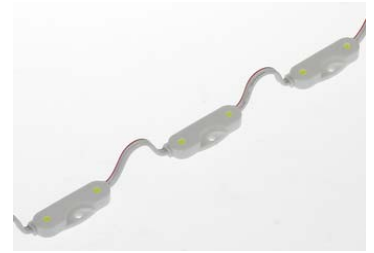

FEATURES

- Energy efficient (up to 80% energy efficiency over neon)
- Long service life (up to 30,000 hours)
- Easy installation and maintenance
- 100% waterproof (IP67)
- Safety due to low voltage operation (12VDC)
- 3 year warranty

APPLICATIONS

- Signage (slim channel letters)
- Indoor & outdoor lighting decorations

CERTIFICATIONS

- UL (E258512), CE, RoHS



MATERIALS

- CASE : PBT (UL Recognized), WIRE : SPT-1 (105°C)

SPECIFICATIONS

• Operating Temp. : -20°C~+70°C

Color	White
Model	WL-BFL225S-DW12
Input Voltage	12VDC
Operating Current	0.06A (Max.)
Power Consumption	0.72W (Max.)
Dimensions	57mm(L) x 19mm(W) x 8mm(H)
Viewing angle	120°
Luminous Flux (Typ.)	26lm
Wavelength Color Temp.	8,200K~15,000K 6,000K~8,200K



PHYSICAL SPECIFICATION (Unit : mm)

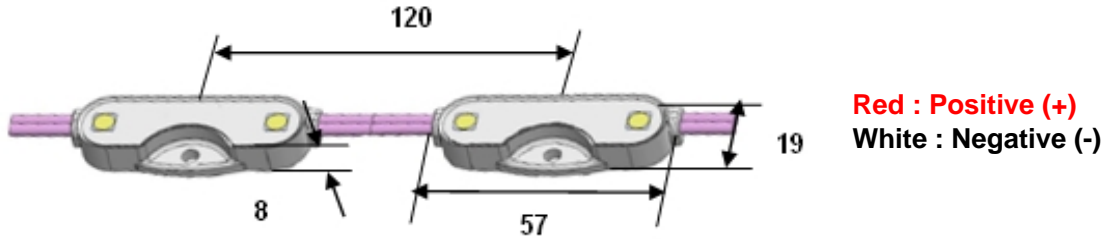

LUMINOUS INTENSITY DISTRIBUTION (WHITE, Unit : cd)

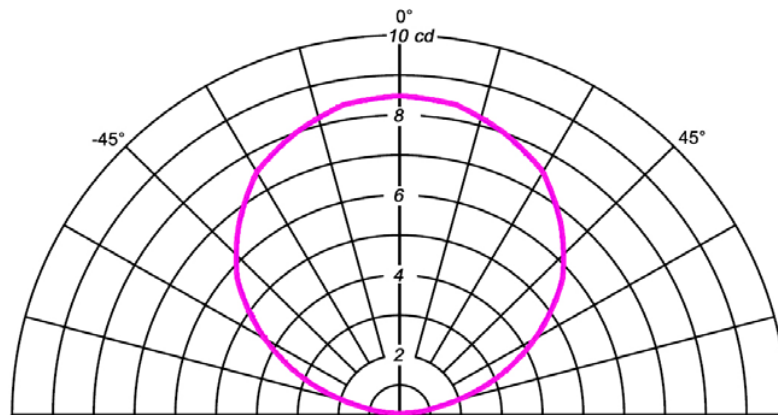

ILLUMINATION DISTRIBUTION (WHITE, Unit : lx)

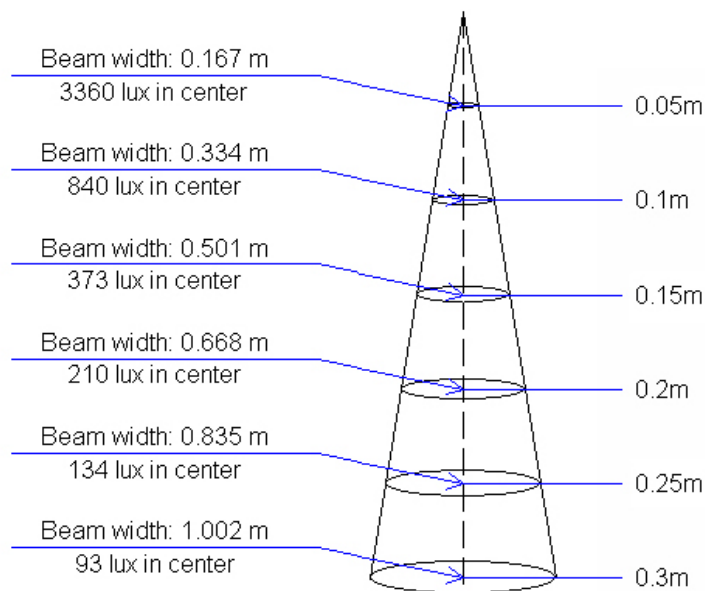

LUMINOUS FLUX RANK

Ta=25°C

Rank		White
O	22~28(lm)	●

* Measurement allowance is $\pm 10\%$

COLOR RANK

Ta=25°C

Rank		Color Coordinates				CCT	
A	x	0.2805	0.2896	0.2833	0.2725	10,200K~ 15,000K	
	y	0.2465	0.2648	0.2763	0.2564		
C	x	0.2725	0.2833	0.2783	0.2655		
	y	0.2564	0.2763	0.2854	0.2650		
B	x	0.2896	0.2995	0.2951	0.2833		8,200K~ 10,200K
	y	0.2648	0.2849	0.2981	0.2763		
D	x	0.2833	0.2951	0.2919	0.2783		
	y	0.2763	0.2981	0.3077	0.2854		
G	x	0.2951	0.3065	0.3046	0.2919	7,000K~ 8,200K	
	y	0.2981	0.3192	0.3285	0.3077		
E	x	0.2976	0.3081	0.3065	0.2951		
	y	0.2906	0.3110	0.3192	0.2981		
H	x	0.3065	0.3178	0.3165	0.3046	6,000K~ 7,000K	
	y	0.3192	0.3401	0.3480	0.3285		
F	x	0.3081	0.3190	0.3178	0.3065		
	y	0.3110	0.3322	0.3401	0.3192		

* Measurement allowance is ± 0.01

<Serial No.>

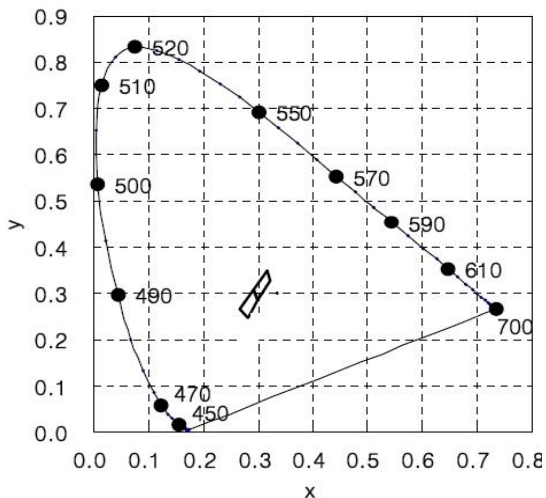

H 7 OG W	
H	Manufacturing year - 2001 : A,2008 : H.....
7	Month - 1~9 : 1~9 Ex) July. - "7" - 10 : "X" - 11 : "Y" - 12 : "Z"
OG	Rank (O : Luminous flux rank , G : Color rank)
W	LED Color

PACKAGE

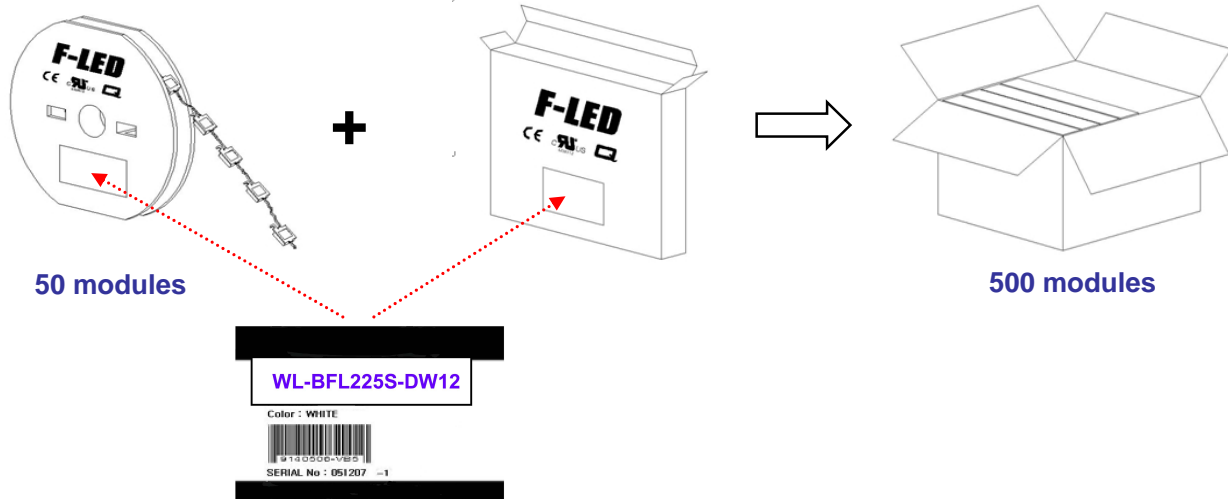

APPLICATION EXAMPLES



INSTALLATION

- Determine number of modules, pitch and power supplies needed based on channel depth, stroke, cover materials, total power consumption of the modules, etc.

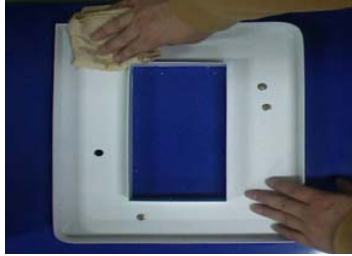

1) Clean inside the channel letters.

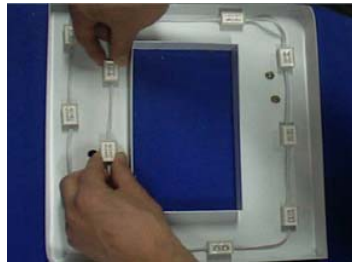

2) Remove VHB tape on the backside of the modules and attach modules according to the layout determined. For secure mounting, use screws or silicone.



3) Connect modules in series or parallel with wire nuts or electric tape after considering the maximum number of the module in series. Cap all unused wires. Place silicone into the wire nuts for secure outdoor protection.

⚠ Caution :

Check polarity. All connections must be Red (+ : Positive) to Red and White (- : Negative) to White.



4) Drill holes at the bottom or side of the letters for the wire connection to DC power supplies, put the bushings into the holes and thread wires out of the letters.



5) Connect DC wires from the letters to DC power supplies and AC wires from input power source to DC power supplies. Check DC polarity (+ : Positive, - : Negative) and AC connection (L, N, FG : 1 phase, 100~240VAC, 50/60Hz).

⚠ Caution :

Electric power should be off when DC and AC wires are connected to DC power supplies.

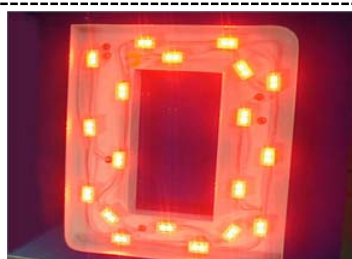

6) Turn on electric power and check all modules for illumination. Review all installation steps above if F-LED 125 fails to light.

INSTALLATION

- Recommended channel depth : **70mm~90mm** (less than 70mm depth, some dots may be seen through the cover)
- Recommended installation pitch between centers of the modules : **100mm at 70mm~90mm depth**
- Maximum number of modules connected in series : **50 modules**
- Installation layout (example) : Channel height-500mm, Channel depth-80mm, Stroke width-100mm

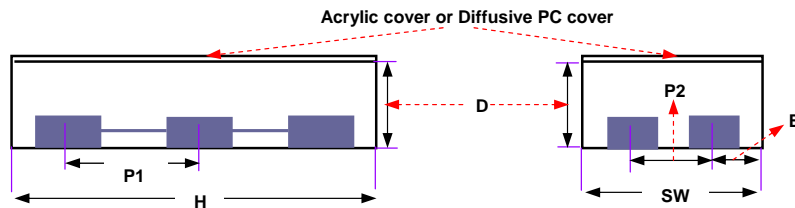
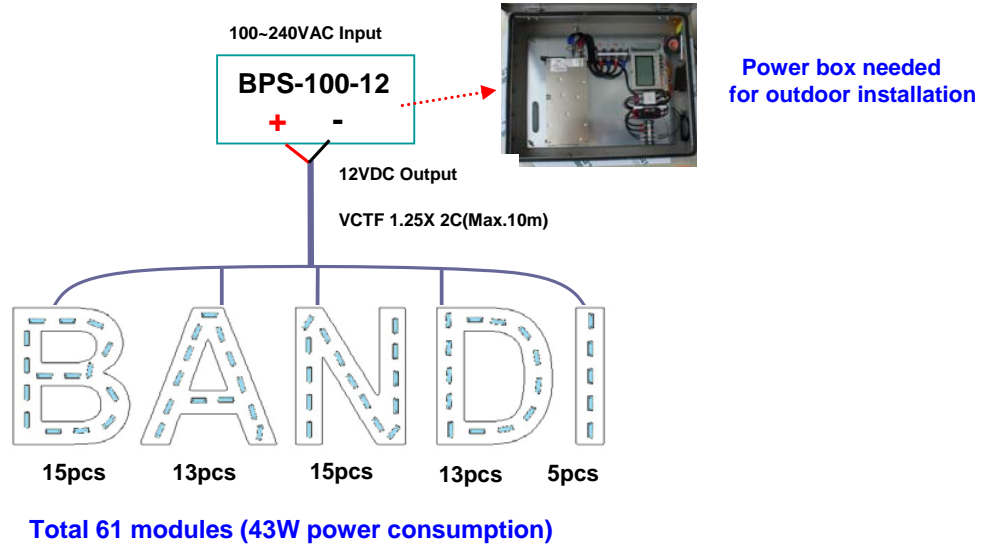

H	Channel Letter Height	
D	Channel Letter Depth	70mm~90mm
SW	Channel Letter Stroke Width	
E	Distance between the center of the LED module to the edge of the Channel Letter	30mm~50mm
P1	Installation pitch in a row	100mm
P2	Installation pitch in a column	70mm

■ Primary DC Cable Specification Table

Module Number connected	Cable Specification
~200 modules	VCTF 1.25X2C
~300 modules	VCTF 2.0X2C
~500 modules	VCTF 3.5X2C
~700 modules	VCTF 5.5X2C

■ Power Supply Capacity Table

Power Supply	Max. Module Number connected
BPS-020-12 (20W,Outdoor)	20 modules
BPS-040-12 (40W Outdoor)	40 modules
BPS-060-12 (60W Outdoor)	60 modules
BPS-100-12 (100W,Indoor)	100 modules
BPS-300-12 (300W,Indoor)	300 modules
BPS-600-12 (600W,Indoor)	600 modules