

Optocoupler, Photodarlington Output, Dual Channel, SOIC-8 package

Features

- Two Channel Optocoupler
- High Current Transfer Ratio at $I_F = 1.0 \text{ mA}$, 500 % Min.
- Isolation Test Voltage, 3000 V_{RMS}
- Electrical Specifications Similar to Standard 6-pin Coupler
- Compatible with Dual Wave, Vapor Phase and IR Reflow Soldering
- SOIC-8 Surface Mountable Package
- Standard Lead Spacing, .05 "
- Available only on Tape and Reel (Conforms to EIA Standard 481-2)
- Lead-free component
- Component in accordance to RoHS 2002/95/EC and WEEE 2002/96/EC

Agency Approvals

- UL1577, File No. E52744 System Code Y

Description

The ILD223T is a high current transfer ratio (CTR) optocoupler. It has a Gallium Arsenide infrared LED emitter and silicon NPN photodarlington transistor detector.

Absolute Maximum Ratings

$T_{amb} = 25 \text{ }^\circ\text{C}$, unless otherwise specified

Stresses in excess of the absolute Maximum Ratings can cause permanent damage to the device. Functional operation of the device is not implied at these or any other conditions in excess of those given in the operational sections of this document. Exposure to absolute Maximum Rating for extended periods of the time can adversely affect reliability.

Input

Parameter	Test condition	Symbol	Value	Unit
Peak reverse voltage		V_R	6.0	V
Peak pulsed current	1.0 μs , 300 pps		3.0	A
Continuous forward current per channel			30	mA
Power dissipation		P_{diss}	45	mW
Derate linearly from 25 $^\circ\text{C}$			0.4	mW/ $^\circ\text{C}$

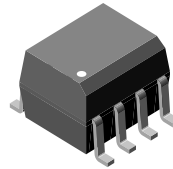

1179042

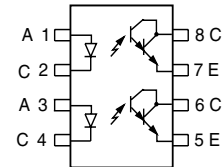

This device has CTRs tested at an LED current of 1.0 mA. This low drive current permits easy interfacing from CMOS to LSTTL or TTL.

The ILD223T is constructed in a standard SOIC - 8 A foot print which makes it ideally suited for high density applications. In addition to eliminating through hole requirements, this package conforms to standards for surface mounted devices.

Order Information

Part	Remarks
ILD223T	CTR > 500 %, SOIC-8

For additional information on the available options refer to Option Information.

Output

Parameter	Test condition	Symbol	Value	Unit
Collector-emitter breakdown voltage		BV_{CEO}	30	V
Emitter-collector breakdown voltage		BV_{ECO}	5.0	V
Power dissipation per channel		P_{diss}	75	mW
Derate linearly from 25°C			3.1	mW/°C

Coupler

Parameter	Test condition	Symbol	Value	Unit
Total package dissipation (2 LEDs + 2 detectors, 2 channels)		P_{tot}	240	mW
Derate linearly from 25°C			2.0	mW/°C
Storage temperature		T_{stg}	- 55 to + 150	°C
Operating temperature		T_{amb}	- 55 to + 100	°C
Soldering time at 260°C		T_{sld}		

Electrical Characteristics

$T_{amb} = 25\text{ °C}$, unless otherwise specified

Minimum and maximum values are testing requirements. Typical values are characteristics of the device and are the result of engineering evaluation. Typical values are for information only and are not part of the testing requirements.

Input

Parameter	Test condition	Symbol	Min	Typ.	Max	Unit
Forward voltage	$I_F = 1.0\text{ mA}$	V_F			1.3	V
Reverse current	$V_R = 6.0$	I_R		0.1	100	μA
Capacitance	$V_F = 0\text{ V}$, $F = 1.0\text{ MHz}$	C_O		25		pF

Output

Parameter	Test condition	Symbol	Min	Typ.	Max	Unit
Collector-emitter breakdown voltage	$I_C = 10\text{ μA}$	BV_{CEO}	30			V
Emitter-collector breakdown voltage	$I_C = 10\text{ μA}$	BV_{ECO}	5.0			V
Collector-emitter leakage current	$V_{CE} = 5.0\text{ V}$, $I_F = 0$	I_{CEO}			50	nA
Collector-emitter capacitance	$V_{CE} = 5.0\text{ V}$	C_{CE}		3.4		pF

Coupler

Parameter	Test condition	Part	Symbol	Min	Typ.	Max	Unit
Saturation voltage, collector-emitter	$I_F = 1.0\text{ mA}$, $I_{CE} = 0.5\text{ mA}$	ILD223T	V_{CEsat}			1.0	V
Capacitance (input-output)		ILD223T	C_{IO}	0.5			pF
Resistance, input to output		ILD223T	R_{IO}	100			GΩ
Isolation test voltage	$t = 1.0\text{ sec.}$	ILD223T	V_{IO}	3000			V_{RMS}

Current Transfer Ratio

Parameter	Test condition	Symbol	Min	Typ.	Max	Unit
DC Current Transfer Ratio	$I_F = 1.0 \text{ mA}$, $V_{CE} = 5.0 \text{ V}$	CTR_{DC}	500			%

Switching Characteristics

Parameter	Test condition	Part	Symbol	Min	Typ.	Max	Unit
Turn-on time	$V_{CC} = 10 \text{ V}$, $R_L = 100 \Omega$, $I_F = 5.0 \text{ mA}$	ILD223T	t_{on}	15			μs
Turn-off time	$V_{CC} = 10 \text{ V}$, $R_L = 100 \Omega$, $I_F = 5.0 \text{ mA}$	ILD223T	t_{off}	30			μs

Typical Characteristics (Tamb = 25 °C unless otherwise specified)

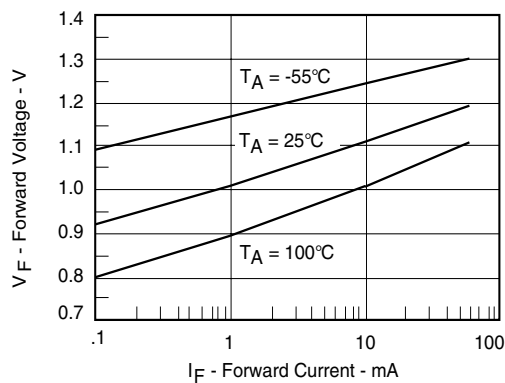

ild223t_01

Figure 1. Forward Voltage vs. Forward Current

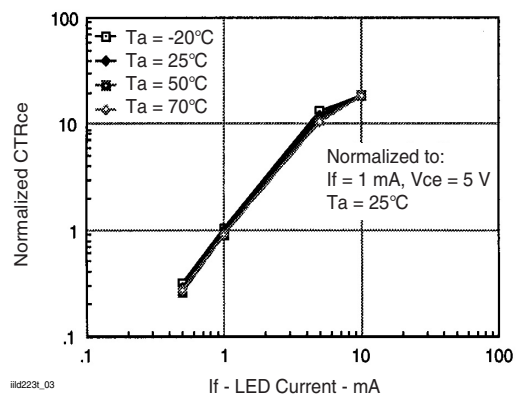

ild223t_03

Figure 3. Normalized CTR_{CE} vs. LED Current

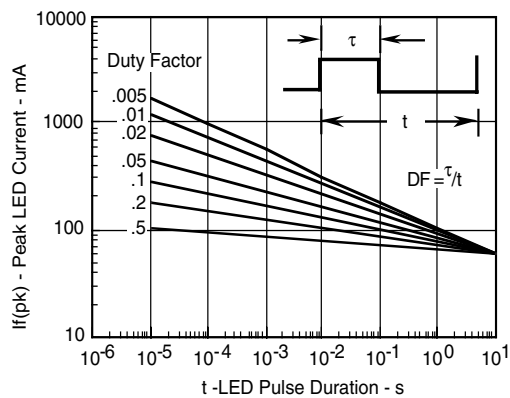

ild223t_02

Figure 2. Peak LED Current vs. Duty Factor, Tau

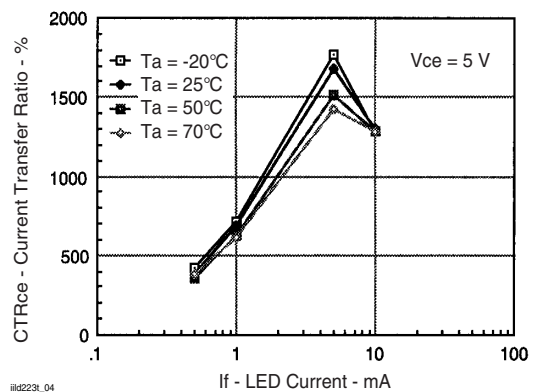

ild223t_04

Figure 4. CTR vs. LED Current

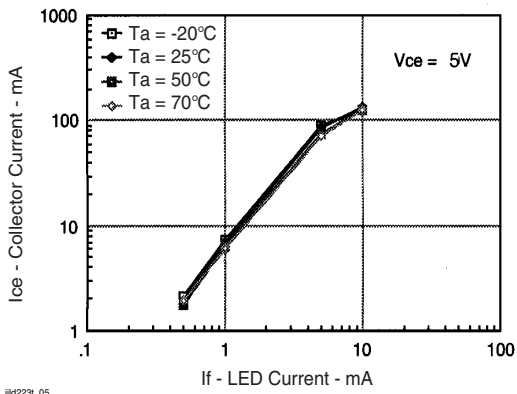

ild223t_05

Figure 5. Collector Current vs. LED Current

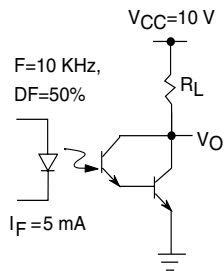

ild223t_06

Figure 6. Switching Schematic

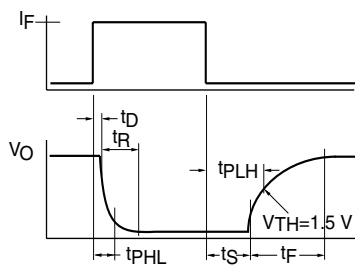

ild223t_07

Figure 7. Switching Timing

Package Dimensions in Inches (mm)

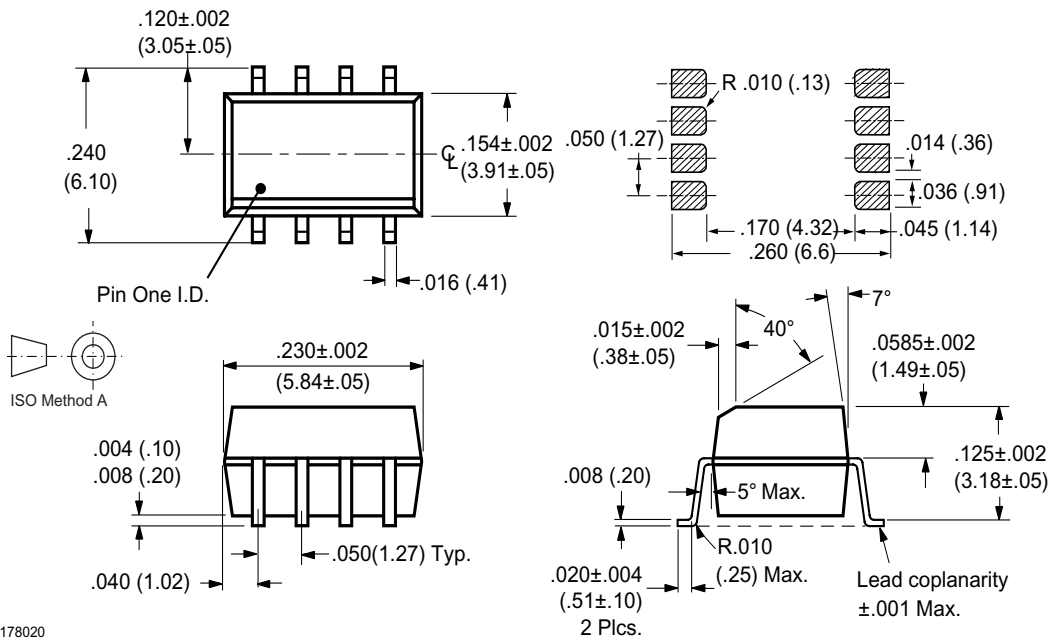

Ozone Depleting Substances Policy Statement

It is the policy of Vishay Semiconductor GmbH to

1. Meet all present and future national and international statutory requirements.
2. Regularly and continuously improve the performance of our products, processes, distribution and operating systems with respect to their impact on the health and safety of our employees and the public, as well as their impact on the environment.

It is particular concern to control or eliminate releases of those substances into the atmosphere which are known as ozone depleting substances (ODSs).

The Montreal Protocol (1987) and its London Amendments (1990) intend to severely restrict the use of ODSs and forbid their use within the next ten years. Various national and international initiatives are pressing for an earlier ban on these substances.

Vishay Semiconductor GmbH has been able to use its policy of continuous improvements to eliminate the use of ODSs listed in the following documents.

1. Annex A, B and list of transitional substances of the Montreal Protocol and the London Amendments respectively
2. Class I and II ozone depleting substances in the Clean Air Act Amendments of 1990 by the Environmental Protection Agency (EPA) in the USA
3. Council Decision 88/540/EEC and 91/690/EEC Annex A, B and C (transitional substances) respectively.

Vishay Semiconductor GmbH can certify that our semiconductors are not manufactured with ozone depleting substances and do not contain such substances.

We reserve the right to make changes to improve technical design
and may do so without further notice.

Parameters can vary in different applications. All operating parameters must be validated for each customer application by the customer. Should the buyer use Vishay Semiconductors products for any unintended or unauthorized application, the buyer shall indemnify Vishay Semiconductors against all claims, costs, damages, and expenses, arising out of, directly or indirectly, any claim of personal damage, injury or death associated with such unintended or unauthorized use.

Vishay Semiconductor GmbH, P.O.B. 3535, D-74025 Heilbronn, Germany
Telephone: 49 (0)7131 67 2831, Fax number: 49 (0)7131 67 2423