

750H Hermetic Octal Relays, 8-Pin/DPDT, 12 Amp Rating (DC & AC)

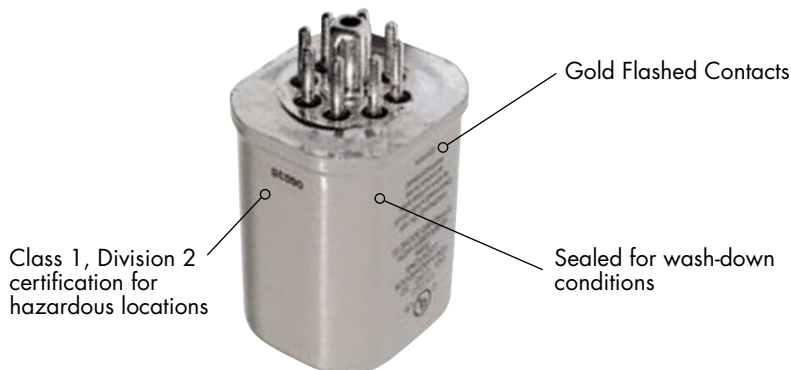

General Specifications

(UL 508)

750XBXH

Contact Characteristics		Units	Standard
Number and type of Contacts			DPDT
Contact materials			Silver Alloy
Thermal (Carrying) Current		A	12
Maximum Switching Voltage		V	300
Switching Current @ Voltage	~	General Purpose	12A @ 240V 50/60Hz
	~	General Purpose	12A @ 120V 50/60Hz
	∴	Resistive	12A @ 28V
		HP	1/3 @ 120VAC
		HP	1/2 @ 240 VAC
Minimum Switching Requirement		Pilot Duty mA	B300 100 @ 5VDC (.5W)
Coil Characteristics			
Voltage Range	~	V	6...240
	∴	V	6...125
Operating Range	% of Nominal	~	85% to 110%
		∴	80% to 110%
Average consumption	~	VA	1.2
	∴	W	0.9
Drop-out voltage threshold	~		15%
	∴		10%
Performance Characteristics			
Electrical Life (UL508)	Operations @ Rated Current		100,000
Mechanical Life	Unpowered		10,000,000
Operating time (response time)		ms	20
Dielectric strength	Between coil and contact	~	Vrms 1500
	Between poles	~	Vrms 1500
	Between contacts	~	Vrms 1500
Environment			
Product certifications	Standard version		UL
Ambient air temperature around the device	Storage	°C	-40...+85
	Operation	°C	-40...+55
Vibration resistance	Operational	g-n	3, 10 - 55 Hz
Shock resistance		g-n	10
Degree of protection			IP 67
Weight		grams	130

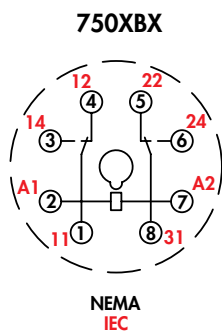

**Wiring Diagram
Bottom View**

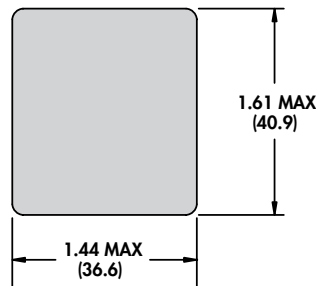
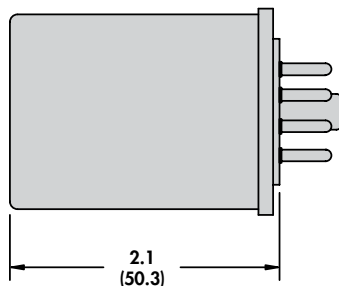



750H 8-pin

Standard Part Numbers

BOLD-FACED PART NUMBERS ARE NORMALLY STOCKED

Nominal Voltage	Coil Resistance	DPDT Part Number 12 Amp
AC Operated		
6 VAC 50/60 Hz	4.2 Ohms	750XBXH-6A
12 VAC 50/60 Hz	18 Ohms	750XBXH-12A
24 VAC 50/60 Hz	72 Ohms	750XBXH-24A
120 VAC 50/60 Hz	1700 Ohms	750XBXH-120A
220-240 VAC 50/60 Hz	7200 Ohms	750XBXH-220/240A
DC Operated		
6 VDC	32 Ohms	750XBXH-6D
12 VDC	120 Ohms	750XBXH-12D
24 VDC	470 Ohms	750XBXH-24D
48 VDC	1800 Ohms	750XBXH-48D
110-125 VDC	10000 Ohms	750XBXH-110/125D

Custom Relay Part Number Builder

Series	Contact Configuration	Hermetic	Contact Code	Coil Voltage
750	XBH	H		240A
750	XBH = DPDT		12 Amp Silver Alloy = No Code	VAC = 6 - 240A VDC = 6 - 125D

For other mating sockets, see Section 2: 70-750E8-1, 70-464-1, 70-169-1

16-1332
Metal Hold-Down Clip
Section 3, p.8-11

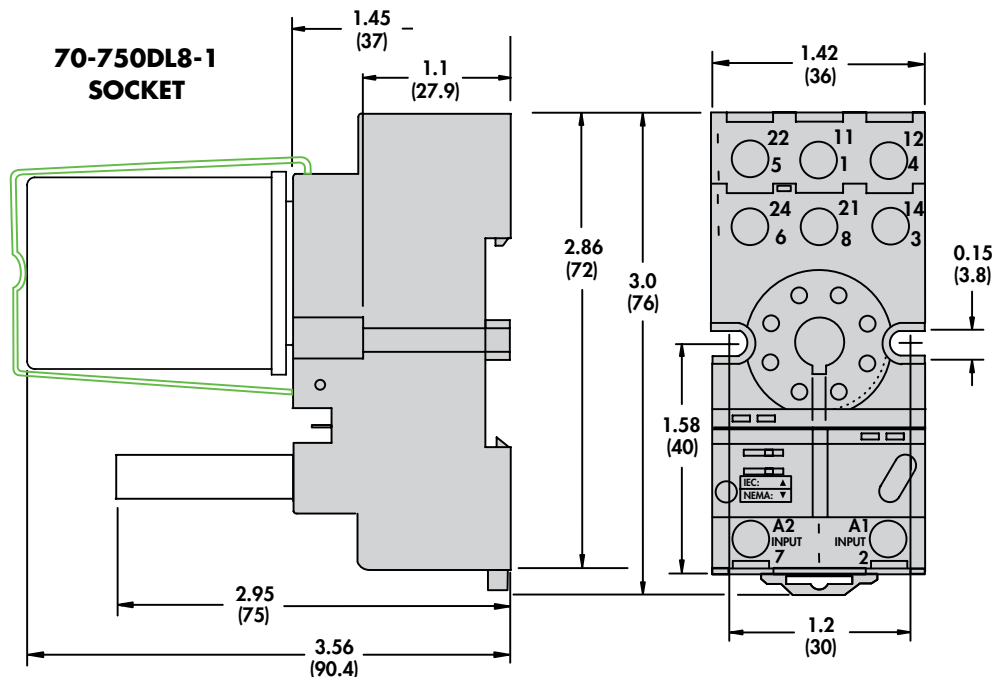

750H Hermetic Octal Relays, 11-Pin/3PDT, 12 Amp Rating (DC & AC)

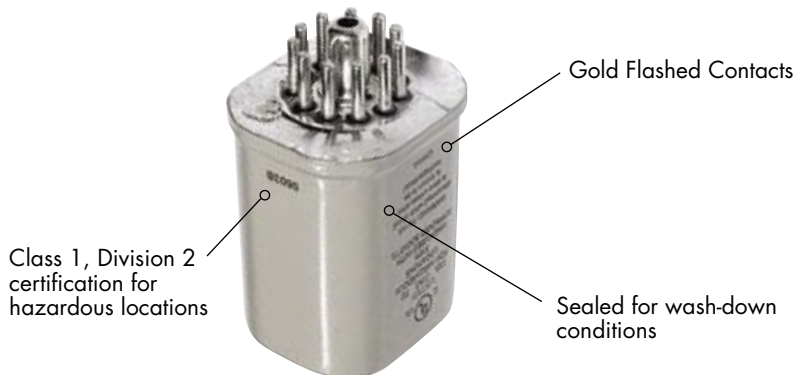

General Specifications

(UL 508)

750XCXH

Contact Characteristics		Units	Standard
Number and type of Contacts			3PDT
Contact materials			Silver Alloy
Thermal (Carrying) Current		A	12
Maximum Switching Voltage		V	300
Switching Current @ Voltage		~ General Purpose	12A @ 240V 50/60Hz
		~ General Purpose	12A @ 120V 50/60Hz
		≡ Resistive	12A @ 28V
		HP	1/3 @ 120VAC
		HP	1/2 @ 240 VAC
		Pilot Duty	B300
Minimum Switching Requirement		mA	100 @ 5VDC (.5W)
Coil Characteristics			
Voltage Range		~ V	6...240
		≡ V	6...125
Operating Range		~ % of Nominal	85% to 110%
		≡	80% to 110%
Average consumption		~ VA	2
		≡ W	1.2
Drop-out voltage threshold		~	15%
		≡	10%
Performance Characteristics			
Electrical Life (UL508)		Operations @ Rated Current	100,000
Mechanical Life		Unpowered	10,000,000
Operating time (response time)			20 ms
Dielectric strength		Between coil and contact	~ Vrms 1500
		Between poles	~ Vrms 1500
		Between contacts	~ Vrms 1500
Environment			
Product certifications		Standard version	UL
Ambient air temperature around the device		Storage	-40...+85 °C
		Operation	-40...+55 °C
Vibration resistance		Operational	g-n 3, 10 - 55 Hz
Shock resistance			g-n 10
Degree of protection			IP 67
Weight		grams	130

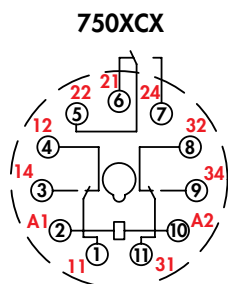

NEMA IEC
Wiring Diagram
Bottom View

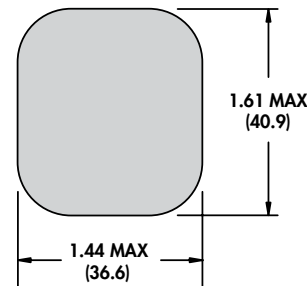
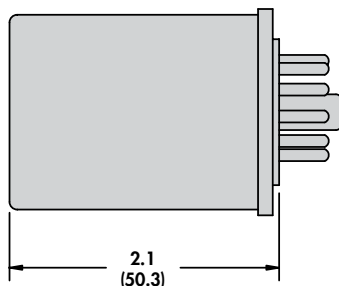



750H 11-pin

Standard Part Numbers

BOLD-FACED PART NUMBERS ARE NORMALLY STOCKED

Nominal Voltage	Coil Resistance	3PDT Part Number 12 Amp
AC Operated		
6 VAC 50/60 Hz	4.2 Ohms	750XCXH-6A
12 VAC 50/60 Hz	18 Ohms	750XCXH-12A
24 VAC 50/60 Hz	72 Ohms	750XCXH-24A
120 VAC 50/60 Hz	1700 Ohms	750XCXH-120A
220-240 VAC 50/60 Hz	7200 Ohms	750XCXH-220/240A
DC Operated		
6 VDC	32 Ohms	750XCXH-6D
12 VDC	120 Ohms	750XCXH-12D
24 VDC	470 Ohms	750XCXH-24D
48 VDC	1800 Ohms	750XCXH-48D
110-125 VDC	10000 Ohms	750XCXH-110/125D

Custom Relay Part Number Builder

750	XCX	H		240A
Series	Contact Configuration	Hermetic	Contact Code	Coil Voltage
750	XCX = 3PDT		12 Amp Silver Alloy = No Code	VAC = 6 - 240A VDC = 6 - 125D

For other mating sockets, see Section 2: 70-750E11-1, 70-465-1, 70-170-1

16-1332
Metal Hold-Down Clip
Section 3, p.8-11

