

LITHIUM - Vanadium Pentoxide Rechargeable

Panasonic Vanadium Pentoxide (VL Type) rechargeable lithium batteries are compact, high energy secondary batteries that have nearly twice the energy of conventional button-shaped Ni-Cd batteries.



Features:

- One high-voltage battery can serve your backup needs
- Can provide the voltage equivalent of two or three 1.2V Ni-Cd's or two capacitors
- Months of continuous use as a backup
- Self discharge rate less than 2% a year
- Superior reliability; withstands overcharging and discharging

Applications:

- ECRs
- Memory back-up in facsimiles
- Memory cards
- Personal computers
- Sequencers
- Telephones
- Tuners
- Video cameras
- VTRs

Technical Data - Table 1 - Lithium Vanadium Pentoxide Rechargeable (VL)

Model No.	Nominal Voltage (V)	Nominal Capacity (mAh)	Dimensions (mm)		Basic Battery Weight (g)	Continuous Drain (mA)	Tab Configurations
			External Diameter	Height			
VL621	3.0	1.5	6.8	2.1	0.3	0.01	
VL1220	3.0	7.0	12.5	2.0	0.8	0.03	
VL2020	3.0	20.0	20.0	2.0	2.2	0.07	
VL2320	3.0	30.0	23.0	2.0	2.8	0.10	
VL2330	3.0	50.0	23.0	3.0	3.7	0.10	
VL3032	3.0	100.0	30.0	3.2	6.3	0.20	

Technical Data - Table 2 - Tab Configurations and Distributor Inventory

Model No.	Tab Description Drawing	
VL621/F9D	2 Pin, flat mount (w/o insulation wrap)	
VL1220/1HF	2 Pin, horizontal mount, through holes, (with insulation wrap)	
VL1220/1VC	2 Pin, vertical mount, through hole, (with insulation wrap)	
VL2020/1VC	2 Pin, vertical mount, through hole, (with insulation wrap)	
VL2020/1HF	2 Pin, horizontal mount, through hole, (with insulation wrap)	
VL2320/1VC	2 Pin, vertical mount, through hole, (with insulation wrap)	
VL2320/1HF	2 Pin, horizontal mount, through hole, (w/o insulation wrap)	
VL2320/1F2	2 Pin, flat mount (w/o insulation wrap)	
VL2330/1VC	2 Pin, vertical mount, through hole, (with insulation wrap)	
VL2330/1HF	2 Pin, horizontal mount, through hole, (with insulation wrap)	
VL2330/1F3	2 Pin, flat mount, (with insulation wrap)	
VL3032/1GUF	3 Pin, horizontal mount, through hole, (w/o insulation wrap)	
VL3032/1F2	2 Pin, flat mount, through hole, (with insulation wrap)	

Vanadium Pentoxide Lithium Coin Batteries (VL Series): Individual Specifications

VL2020

■ Dimensions(mm)

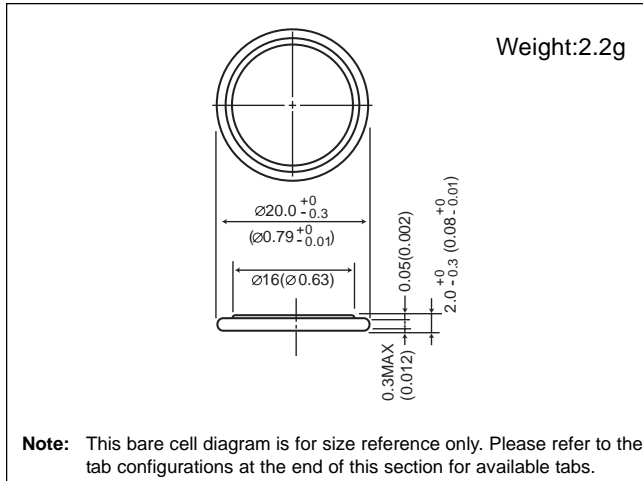

■ Specification

Nominal voltage (V)	3
Nominal capacity (mAh)	20.0
Continuous standard load (mA)	0.07
Operating temperature (C)	-20 ~ +60

■ Discharge Temperature Characteristics

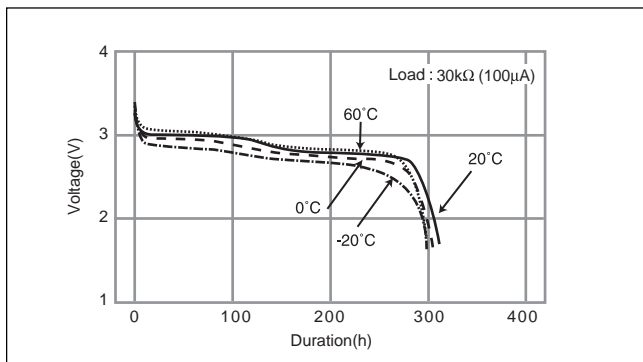

■ Consumption current vs. Duration time

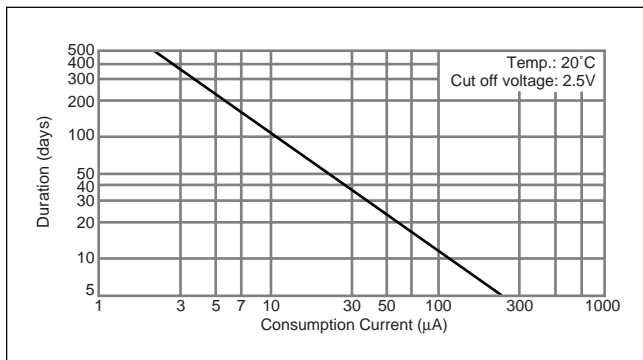

VL2320

■ Dimensions(mm)

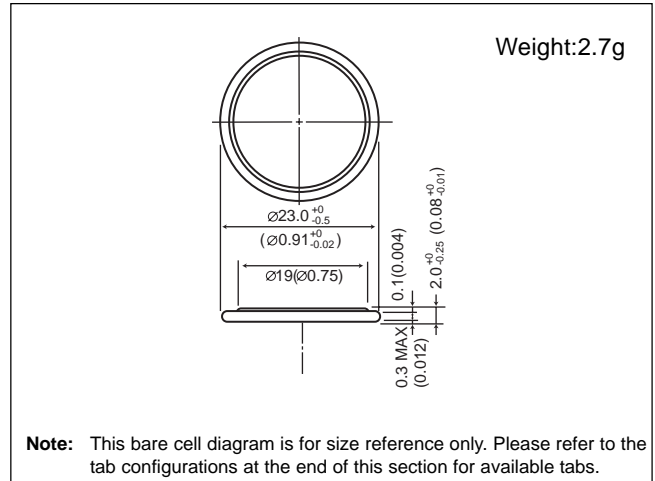

■ Specification

Nominal voltage (V)	3
Nominal capacity (mAh)	30.0
Continuous standard load (mA)	0.1
Operating temperature (C)	-20 ~ +60

■ Discharge Temperature Characteristics

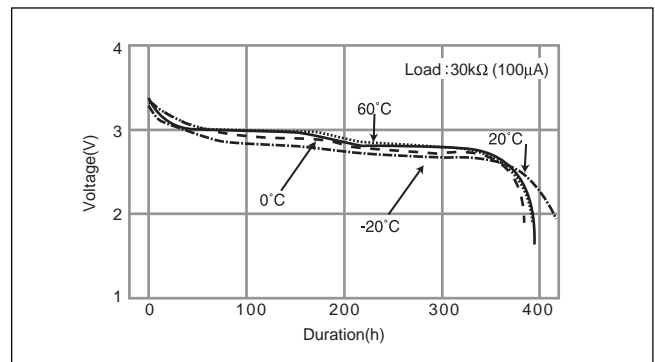

■ Consumption current vs. Duration time

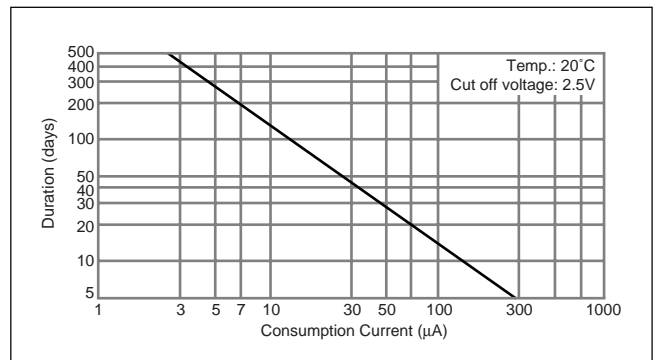

Rechargeable Lithium Coin Batteries

Vanadium Pentoxide Lithium Rechargeable Batteries (VL series)



Features

These coin-type lithium batteries feature vanadium oxide for the positive pole, lithium alloy for the negative pole and a non-aqueous solvent for the electrolyte.

Construction

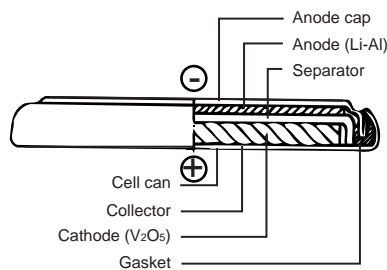

Applications

- Memory backup power supplies for office automation equipment (personal computers, fax machines, etc.), audio-video equipment (VTRs, etc.), communications equipment (mobile phones, etc.), etc.
- Hybrid systems with solar batteries (solar remote controllers, etc.)



General Specifications

Model	Electrical Characteristics (20°C)			Dimensions (mm)		Weight (g)	JIS	IEC
	Nominal Voltage (V)	*Nominal Capacity (mAh)	Continuous Drain (mA)	Diameter	Height			
VL621	3	1.5	0.01	6.8	2.1	0.27	-	-
VL1220	3	7.0	0.02	12.5	2.0	0.8	-	-
VL2020	3	20.0	0.07	20.0	2.0	2.2	-	-
VL2320	3	30.0	0.10	23.0	2.0	2.7	-	-
VL2330	3	50.0	0.10	23.0	3.0	3.5	-	-
VL3032	3	100.0	0.20	30.0	3.2	6.2	-	-

* Nominal capacity shown above is based on standard drain and cut off voltage down to 2.5V at 20°C.

Vanadium Pentoxide Lithium Rechargeable Batteries (VL Series):

TAB CONFIGURATIONS

Model No.	Tab Type		Configuration Diagram No.	Nominal	
	With Insulation Wrap	Without Insulation Wrap		Voltage (V)	Capacity (mAh)
VL621		/F9D	1	3	1.5
VL1220	/1HF		2	3	7
	/1VC		3	3	7
	/1FC		4	3	7
	/1FC2		5	3	7
		/1F5U	6	3	7
VL2020	/1VC		7	3	20
	/1GU7		8	3	20
	/1HF		9	3	20
VL2320	/1VC		10	3	30
	/1HF		11	3	30
	/1F2		12	3	30
VL2330	/1VC		13	3	50
	/1HF		14	3	50
	/1F3		15	3	50
VL3032		/1GUF	16	3	100
	/1F2		17	3	100

Notes:

- A) To ensure proper electrical contact, it is recommended that rechargeable coin cell batteries be used with tabs for PC Board mounting.
- B) Please contact Panasonic for requests on custom tab configurations. Minimum order requirements may apply.

VL Series Tab Configurations

DIMENSIONS / MM (INCH)

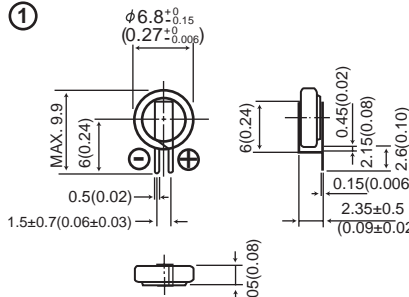
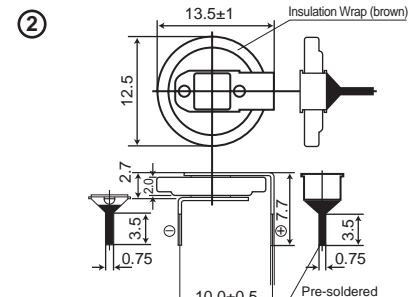
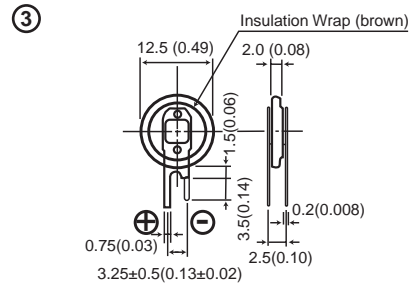
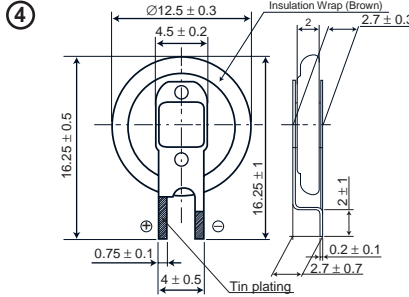
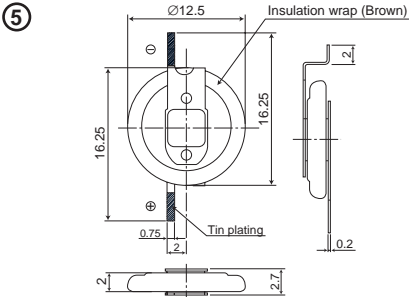
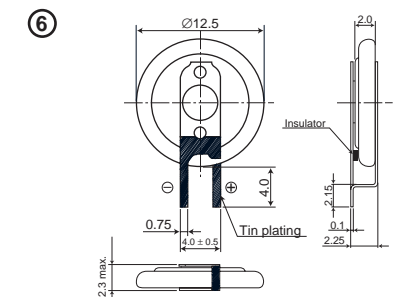
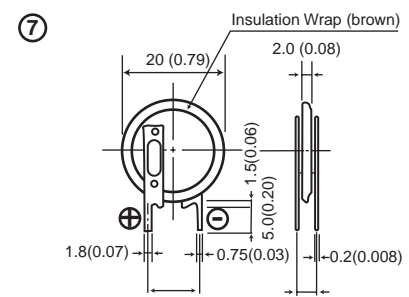
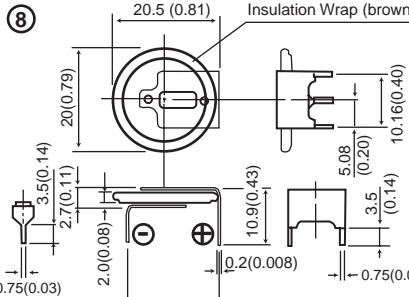
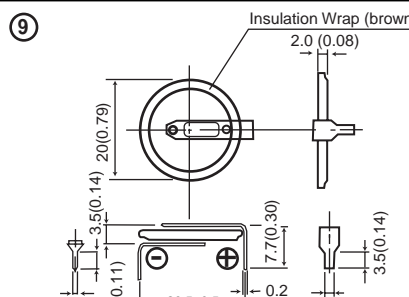
Model No.	Dimensions/mm (inch)	Model No.	Dimensions/mm (inch)
VL621/F9D (1.5mAh)		VL1220/1HF (7mAh)	
VL1220/1VC (7mAh)		VL1220/1FC (7mAh)	
VL1220/1FC2 (7mAh)		VL1220/1F5U	
VL2020/1VC (20mAh)		VL2020/1GU7 (20mAh)	
VL2020/1HF (20mAh)		VL2320/1VC (30mAh)	