

SEARCH OUR PRODUCTS

aluminum electrolytic & organic semiconductor

film

power film

 
tantalum ceramic

TECH TOOLS



Aluminum Electrolytic Capacitors

+85°C Standard Radial Lead Aluminum Electrolytic Capacitors

Part Number: 477CKS010M

[General Specifications \(PDF\)](#)

[Special Order Options](#)

[CKR_CKS document \(PDF\)](#)



Electrical Specifications

Capacitance: 470.0 μ F
Tolerance: -20 %, +20 %
Dissipation Factor: 0.2 at 120 Hz
ESR: 0.67 Ohms at 20° C and 120 Hz
Impedance:
 --
 --

Temperature Range: -40°C to +85°C
WVDC: 10 volts DC
SVDC: 13. volts DC
Leakage Current:
 141.0 μ A after 1 Minute
Ripple Current:
 370.0 mA at 120 Hz and 85°C

Impedance Ratios:

4.0 at -25°C/20°C
 10.0 at -40°C/20°C

Load Life:

2000 Hours at 85°C with 100% of rated voltage and with 0% of rated ripple current

Physical Specifications

Diameter (D): 6.3 mm + 0.5 mm
Length (L): 11.0 mm + 1.5 mm
Lead Wire Diameter (d): 0.5 mm + 0.05 mm
Lead Spacing: 2.5 mm +/- 0.5 mm
Lead Length: 15 mm

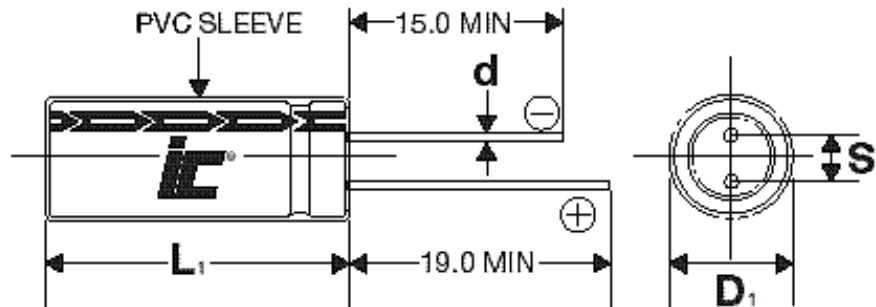

 **Add To Sample Cart**
 (You can always remove it later)

[Site Map](#)

[View Items in Shopping Cart](#)

Illinois Capacitor, Inc.
3757 West Touhy Avenue
Lincolnwood, IL 60712 USA
Tel:847.675.1760 Fax:847.673.2850
email:sales@illcap.com

[Products](#) | [Profile](#) | [Press](#) | [Employment](#) | [Links](#) | [Contact](#) | [Home](#) | [Search by Application](#) | [Search by Parameters](#) | [Search by Part Number](#) | [Search by Competitor Series](#) | [Search Distributor Inventory](#) | [Search in Diagram View](#) | [Tech Center](#)
[Site Map](#) | [Aluminum Electrolytic](#) | [Film](#) | [Power Film](#) | [Ceramic](#) | [Shopping Cart](#) | [FAQs](#) | [Catalog PDF Files](#)

©Copyright 2003, Illinois Capacitor, Inc. [Legal Notices](#)

Illinois Capacitor, Inc. reserves the right to make changes from the specifications herein in the construction and design of its capacitors from time to time without notice. The information and specifications included herein are believed to be accurate and reliable; Illinois Capacitor, Inc. Assumes No Responsibility For Correctness, Specific Application Or Uses. NO WARRANTIES ARE EXPRESSED OR IMPLIED. Illinois Capacitor, Inc. specifically disclaims any implied warranties of merchantability or fitness for any particular purpose.