

TW Series – 22mm NEMA Style Pushbuttons



TW NEMA Style Switches with snap-on contacts

Key features include:

- Corrosion resistant octagonal chrome plated locking bezel
- Snap-on 10A contact blocks
- Incandescent or LED illumination
- Slow make, double break, self cleaning contacts
- Modular construction for maximum flexibility
- NEMA 4X and IP65 watertight/oiltight panel
- Available assembled or as sub-components
- Large M3.5 screw terminals with captive sems plate

IDEC has your 22mm switching needs covered.

Button styles include flush, extended, mushroom, or square and all bodies are crafted from fracture-resistant nylon.

All illuminated units feature two lense styles, one that maximizes light dispersion, the other accommodates direct lens engraving.

Self cleaning contact mechanisms allow for a wide current rating, 5mA to 10A, which reduces the need for various contact materials.

When looking for a 22mm switch that is durable, easy to use, and versatile, then IDEC's TW series is your solution.



UL Listed
File No. E70646



TUV Rheinland



CSA Approved
File No. LR21451



File No. DK95-01696



Switches & Pilot Lights

Display Lights

Relays & Sockets

Timers

Terminal Blocks

Circuit Breakers

Conforming to Standards	EN60947-1, EN60947-5-1, VDE0660-200, UL508, CSA C22-2 No.14
Approvals	File No. E70646 File No. LR21451 Certificate No. 2030010305027380 TÜV Rheinland CE Registration No: J9551802 (E-Stops) Registration No: J9551803 (All other switches) Registration No: J9551804 (Pilot Lights)
Operating Temperature	Operation: -25 to +50°C (without freezing), Storage: -40 to +80°C (without freezing)
Vibration Resistance	5 to 55Hz, 100m/sec ² (10g) conforming to IEC6068-2-6
Shock Resistance	1000m/sec ² (100g) conforming to IEC6068-2-7
Electric Shock Protection	Class 0 conforming to IEC60536
Degree of Protection (conforming to IEC60529) (conforming to NEMA ICS6-110)	IP65 from front of the panel; (IP54 for key switches) IP20 (Type HW-F contact block) NEMA 1, 2, 3, 3R, 3S, 4, 4X, 5, 12, 13 (NEMA 1, 2, 3R, 5, 12, 13 for key switches)
Mechanical Life	Momentary pushbuttons: 5,000,000 (900 operations per hour) All other switches: 500,000
Pollution Degree (conforming to IEC60947-1)	3 for switches not using a transformer, 2 for switches using a transformer
Rated Operational Characteristics	AC-15: A600 or Ue = 250V, Ie = 3A (NO, NC, NO-EM, NC-LB) DC-13: P600 or Ue = 125V, Ie = 1.1A (NO, NC) DC-13: Q600 or Ue = 125V, Ie = 0.9A (NO-EM, NC-LB)
Rated Insulation Voltage	600V
Rated Switching Over-Voltage	Less than 4kV, conforming to IEC60947-1
Rated Impulse Withstanding Voltage	4kV for contact circuit, 2.5kV for lamp circuit
Rated Thermal Current	10 Amp
Minimum Switching Capacity	5 mA at 3V AC/DC
Contact Operation	Slow break NC or slow make NO, self-cleaning
Recommended Terminal Torque	0.8 N m (7.1 in lb.)
External Short-Circuit Protection	10A 250V fuse conforming to IEC60269-1
Applicable Wire Size	Minimum 1 x 22 AWG, max. 2 x 14 AWG or 1 x 12 AWG
Contact Resistance	Initial contact resistance of 50mΩ or less
Contact Gap	4mm (NO and NC), 2mm (NO-EM and NC-LB)
Electrical Reliability	MTBF < 1 fault for 10 million operation cycles (3V DC, 5mA)
Lamp Ratings	Incandescent: 1 W LEDs: 6V: 17mA max, 12/24V: 11mA max, 120/240V: 10mA max
Horsepower Rating	1/4 HP @ 120V (single-phase, non-reversing motor); 1 HP @ 240V (3 phase, non-reversing motor)
Maximum Inrush Current	40 A (40 ms)
Contact Material	Silver

Contact Ratings	Pushbuttons	Contact Block	Type HW-C/HW-F
	Illuminated Pushbuttons	Rated Insulation Voltage	600V
	Selector Switches	Rated Continuous Current	10A
	Illuminated Selector Switches Pushbutton Selectors	Contact Ratings by Utilization Category IEC 60947-5-1	AC-15 (A600) DC-13 (P600)

		Contact Ratings by Utilization Category						
		24V	48V	50V	110V	220V	440V	
Operational Current	AC50/60Hz	AC-12 Control of resistive loads and solid state loads	10A	—	10A	10A	6A	2A
		AC-15 Control of electromagnetic loads (> 72VA)	10A	—	7A	5A	3A	1A
	DC	DC-12 Control of resistive loads and solid state loads	8A	5A	—	2.2A	1.1A	—
		DC-13 Control of electromagnets	5A	2A	—	1.1A	0.6A	—

Non-Illuminated Pushbuttons (Assembled)



Assembled Pushbuttons

A B () W 1 10 () - B

Function

B: Momentary
O: Maintained
K: Key On/Off Lock

Bezel Shape

Blank: Octagonal
F: Full Shroud
G: Mushroom Shroud
Q: Square

Button Color

B: Black G: Green W: White
R: Red S: Blue Y: Yellow

Terminal Style

Blank: Standard
N: Fingersafe (IP20)

Contact Arrangement

10: 1NO 01: 1NC
20: 2NO 02: 2NC
11: 1NO-1NC 22: 2NO-2NC

Button Shape

1: Flush
2: Extended
3: Mushroom Head Ø 29mm
4: Mushroom Head Ø 40mm

Series Designation

W: TW Series



To be used for interpreting part numbers only, not for part number development.

Non-Illuminated Pushbuttons (Assembled) continued

Non-Illuminated Pushbuttons

Style	Contacts	Momentary Action	Maintained Action
Flush	1NO	ABW110-①	AOW110-①
	1NC	ABW101-①	AOW101-①
	1NO-1NC	ABW111-①	AOW111-①
	2NO	ABW120-①	AOW120-①
	2NC	ABW102-①	AOW102-①
Extended	1NO	ABW210-①	AOW210-①
	1NC	ABW201-①	AOW201-①
	1NO-1NC	ABW211-①	AOW211-①
	2NO	ABW220-①	AOW220-①
	2NC	ABW202-①	AOW202-①
Recessed	1NO	ABFW110-①	AOFW110-①
	1NC	ABFW101-①	AOFW101-①
	1NO-1NC	ABFW111-①	AOFW111-①
	2NO	ABFW120-①	AOFW120-①
	2NC	ABFW102-①	AOFW102-①
Extended with Full Shroud	1NO	ABFW210-①	AOFW210-①
	1NC	ABFW201-①	AOFW201-①
	1NO-1NC	ABFW211-①	AOFW211-①
	2NO	ABFW220-①	AOFW220-①
	2NC	ABFW202-①	AOFW202-①
ø 29mm Mushroom Head	1NO	ABW310-①	AOW310-①
	1NC	ABW301-①	AOW301-①
	1NO-1NC	ABW311-①	AOW311-①
	2NO	ABW320-①	AOW320-①
	2NC	ABW302-①	AOW302-①
ø 40mm Mushroom Head	1NO	ABW410-①	AOW410-①
	1NC	ABW401-①	AOW401-①
	1NO-1NC	ABW411-①	AOW411-①
	2NO	ABW420-①	AOW420-①
	2NC	ABW402-①	AOW402-①
ø 40mm Mushroom Head with Full Shroud	1NO	ABGW410-①	AOGW410-①
	1NC	ABGW401-①	AOGW401-①
	1NO-1NC	ABGW411-①	AOGW411-①
	2NO	ABGW420-①	AOGW420-①
	2NC	ABGW402-①	AOGW402-①
Square Flush	1NO	ABQW110-①	AQW110-①
	1NC	ABQW101-①	AQW101-①
	1NO-1NC	ABQW111-①	AQW111-①
	2NO	ABQW120-①	AQW120-①
	2NC	ABQW102-①	AQW102-①
Square Extended	1NO	ABQW210-①	AQW210-①
	1NC	ABQW201-①	AQW201-①
	1NO-1NC	ABQW211-①	AQW211-①
	2NO	ABQW220-①	AQW220-①
	2NC	ABQW202-①	AQW202-①
Keylock Push On/Off	1NO	AKW210	—
	1NC	AKW201	—
	1NO-1NC	AKW211	—
	2NO	AKW220	—
	2NC	AKW202	—

① Button Color Codes

Color	Code
Black	B
Green	G
Red	R
Blue	S
Yellow	Y
White	W

Switches & Pilot Lights

Display Lights

Relays & Sockets

Timers

Terminal Blocks

Circuit Breakers

- 1. In place of ①, specify the Button Color Code from table.
- 2. For sub-assembled part numbers, see next page.
- 3. For accessories, see page 593.
- 4. For dimensions, see page 595.
- 5. Keyed switches are supplied with two keys. All units are keyed alike.

Non-Illuminated Pushbuttons (Sub-Assembled)

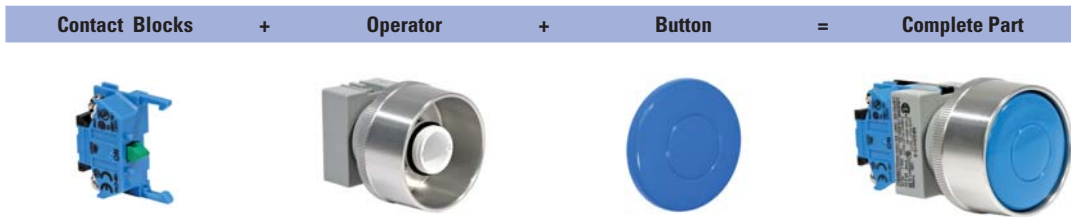

Operators

Style	Part Number	
	Momentary	Maintained
 Round Flush/Extended	ABW-100	AOW-100
 Round with Full Shroud/Recessed	ABFW-200	AOFW-200
 Ø 40mm, Ø 29mm Mushroom Head	ABW-300	AOW-300
 Ø 40mm Mushroom Head with Full Shroud	ABGW-400	AOGW-400
 Square Flush/Extended	ABQW-100	AOQW-100
 Keylock Push On/Off	—	AKW-200

Buttons

Style	Part Number
Round Flush 	ABW1B-Ⓞ
Round Extended 	ABW2B-Ⓞ
Ø 29mm Mushroom 	ABW3B-Ⓞ
Ø 40mm Mushroom 	ABW4B-Ⓞ
Square Flush 	ABQW1B-Ⓞ
Square Extended 	ABQW2B-Ⓞ



In place of Ⓞ specify the button color code from table

Contact Blocks

Style	Part Number	
	1NO	1NC
 Standard Exposed Screw	HW-C10 HW-C10R (early make)	HW-C01 HW-C01R (late break)
 Fingersafe (IP20), CE marked	HW-F10 HW-F10R (early make)	HW-F01 HW-F01R (late break)
 Dummy Block	TW-DB	



- Dummy blocks (no contacts) are used with an odd number of contact blocks.
- Use of early and late break contacts creates a make before break function

① Button Color Codes

Color	Code
Black	B
Green	G
Red	R
Blue	S
Yellow	Y
White	W

E-Stops (Assembled)



Assembled E-Stops

A V (L) W 4 (B) (99) 11 (D) (N) - R - (24V)

Function

V: Pushlock Turn Reset
Y: Push-Pull
X: Pushlock Key Reset

Illumination

Blank: None
L: Illuminated

Series Designation

W: TW Series

Button/Lens Size

3: 29mm Mushroom
4: 40mm Mushroom

Lens Type

(illuminated units only)
Blank: Standard (ribbed)
B: Engravable (smooth with insert)

Illuminated Circuit

(illuminated unit only)
99: Full Voltage (lamp determines voltage)
126: 120V AC Step Down Transformer
246: 240V AC Step Down Transformer
486: 480V AC Step Down Transformer

Lamp Voltage

(full voltage illuminated units only)
6V: 6V AC/DC
12V: 12V AC/DC
24V: 24V AC/DC
120V: 120V AC (LED only)
240V: 240V AC (LED only)

Button/Lens Color

A: Amber R: Red W: White
G: Green S: Blue Y: Yellow
B: Black

Contact Terminal Style

Blank: Standard
N: Fingersafe (IP20)

Lamp Type

(illuminated units only)
Blank: Incandescent
D: LED

Contact Arrangement





10: 1NO 01: 1NC
20: 2NO 02: 2NC
11: 1NO/1NC 22: 2NO/2NC



To be used for interpreting part numbers only, not for part number development.



E-Stops (Assembled) continued

Non-Illuminated E-Stops

Style	Contacts	Part Number
Ø 40mm Pushlock Turn Reset* 	1NO	AVW410-R*
	1NC	AVW401-R*
	1NO-1NC	AVW411-R*
	2NO	AVW420-R*
	2NC	AVW402-R*
Ø 29mm Pushlock Turn Reset* 	1NO	AVW310-R*
	1NC	AVW301-R*
	1NO-1NC	AVW311-R*
	2NO	AVW320-R*
	2NC	AVW302-R*
Ø 40mm Push-Pull 	1NO	AYW410-⊙
	1NC	AYW401-⊙
	1NO-1NC	AYW411-⊙
	2NO	AYW420-⊙
	2NC	AYW402-⊙
Ø 40mm Pushlock Key Reset * 	1NO	AXW410- R*
	1NC	AXW401- R*
	1NO-1NC	AXW411- R*
	2NO	AXW420- R*
	2NC	AXW402- R*

- 1. *Available in Red only.
- 2. In place of ⊙, specify the Button Color Code from table.
- 3. For sub-assembled part numbers, see next page.
- 4. For accessories, see page 593.
- 5. For dimensions, see page 595.

Illuminated E-Stops

Style	Type	Contacts	Part Number
Ø 40mm Pushlock Turn Reset Type 	Transformer	1NO-1NC 2NO 2NC	AVLW4 ⊕ 11 ⊕-R* AVLW4 ⊕ 20 ⊕-R* AVLW4 ⊕ 02 ⊕-R*
	Full Voltage	1NO-1NC 2NO 2NC	AVLW49911 ⊕-R*-⊙ AVLW49920 ⊕-R*-⊙ AVLW49902 ⊕-R*-⊙
	Transformer	1NO-1NC 2NO 2NC	AVLW3 ⊕ 11 ⊕-R* AVLW3 ⊕ 20 ⊕-R* AVLW3 ⊕ 02 ⊕-R*
Ø 29mm Pushlock Turn Reset 	Transformer	1NO-1NC 2NO 2NC	AVLW39911 ⊕-R*-⊙ AVLW39920 ⊕-R*-⊙ AVLW39902 ⊕-R*-⊙
	Full Voltage	1NO-1NC 2NO 2NC	AVLW39911 ⊕-R*-⊙ AVLW39920 ⊕-R*-⊙ AVLW39902 ⊕-R*-⊙
	Transformer	1NO-1NC 2NO 2NC	AYLW4 ⊕ 11 ⊕-⊙ AYLW4 ⊕ 20 ⊕-⊙ AYLW4 ⊕ 02 ⊕-⊙
Ø 40mm Push-Pull 	Transformer	1NO-1NC 2NO 2NC	AYLW4 ⊕ 11 ⊕-⊙ AYLW4 ⊕ 20 ⊕-⊙ AYLW4 ⊕ 02 ⊕-⊙
	Full Voltage	1NO-1NC 2NO 2NC	AYLW49911 ⊕-⊙-⊙ AYLW49920 ⊕-⊙-⊙ AYLW49902 ⊕-⊙-⊙
	Transformer	1NO-1NC 2NO 2NC	AYLW4 ⊕ 11 ⊕-⊙ AYLW4 ⊕ 20 ⊕-⊙ AYLW4 ⊕ 02 ⊕-⊙

- 1. *Available in red only.
- 2. In place of ⊕, specify the Lens Color Code (see table above).
- 3. In place of ⊙, specify the Full Voltage Code (lamp voltage) (see table above).
- 4. In place of ⊕, specify the Transformer Voltage Code (see table above).
- 5. In place of ⊙, specify the Lamp Type Code from table above.
- 6. For sub-assembly part numbers, see next page.
- 7. For accessories, see page 593.
- 8. For dimensions, see page 595.

① Button Color Codes

Color	Code
Black	B
Green	G
Red	R
Blue	S
White	W
Yellow	Y

② LED/Lens Color Codes

Color	Code
Amber	A
Green	G
Red	R
Blue	S
White	W

③ Full Voltage Codes

Voltage	Code
6V AC/DC	6V
12V AC/DC	12V
24V AC/DC	24V
120V AC	120V (LED only)
240V AC	240V (LED only)

④ Transformer Voltage Codes

Voltage	Code
120VAC	126
240VAC	246
480VAC	486

 Transformers step down to 6V.

⑤ Lamp Type Codes

Lamp	Code
Incandescent	Blank
LED	D

E-Stops (Sub-Assembled)



*Not applicable for full voltage units

Operators

Style	Part Number	
	Non-Illuminated	Illuminated
Ø 29/Ø 40mm Push-lock Turn Reset 	AVW-300	AVLW3-0600
Ø 40mm Push-Pull 	AYW-400	AYLW4-0600
Ø 40mm Pushlock Key Reset 	AXW-300	—



Buttons

Style	Part Number
Ø 40mm Pushlock Turn Reset 	AVW4B-R*
Ø 29mm Pushlock Turn Reset 	AVW3B-R*
Ø 40mm Push-Pull 	AYW4B-⓪
Ø 40mm Pushlock Key Reset 	AXW4B-R*



- *Available in Red only
- In place of ⓪, specify the button color code from table.

Contact Blocks

Style	Voltage	Part Number
LED 	6V AC/DC	LSTD-6⓪
	12V AC/DC	LSTD-1⓪
	24V AC/DC	LSTD-2⓪
	120V AC	LSTD-H2⓪
	240V AC	LSTD-M4⓪
Incandescent 	6V AC/DC	IS-6
	12V AC/DC	IS-12
	24V AC/DC	IS-24



- In place of ⓪, specify the LED color code.
- The LED contains a current-limiting resistor and a protection diode.

① Button Color Codes

Color	Code
Black	B
Green	G
Red	R
Blue	S
White	W
Yellow	Y

② LED/Lens Color Codes

Color	Code
Amber	A
Green	G
Red	R
Blue	S
White	W

Switches & Pilot Lights

Display Lights

Relays & Sockets

Timers

Terminal Blocks

Circuit Breakers



Illuminated E-Stops (Sub-Assembled) continued

Lenses

Style	Part Number	
	Standard	Engravable
Ø 29mm Head Pushlock Turn Reset 	AVLW3LU-R*	AVLW3BLU-R*
Ø 40mm Head Pushlock Turn Reset 	AVLW4LU-R*	AVLW4BLU-R*
Ø 40mm Head Push Pull 	AYLW4LU-Ⓢ	AYLW4BLU-Ⓢ

- 1. In place of Ⓢ, specify the lens color code from table on previous page.
- 2. *Available only in red
- 3. Standard lenses have ribbed pattern, Engravable lenses are smooth and include an engravable insert.

Lamp Circuit Components



Style	Application	Part Number
Short Lamp Holder 	Used with a Half-size Transformer and one contact block	TW-LH1
Long Lamp Holder 	Used with Full-size Transformer and two contact blocks Used with Half-size Transformer and three contact blocks Used with Full Voltage Adaptor and two contact blocks	TW-LH2
Lead Holder 	Used with TW-LH2 holder when using four contact blocks	HW-LH3

Transformers/Full Voltage Modules

Style	Description	Part Number
Full Size Transformer 	Standard	120V AC TW-T126B
		240V AC TW-T246B
		480V AC TW-T486B
	Fingersafe	120V AC TW-F126B
		240V AC TW-F246B
		480V AC TW-F486B
Half Size Transformer 	120V AC	TW-T126SB
	240V AC	TW-T246SB
Full voltage model (use with even number of contacts) 	Standard	TW-DA1B
	Fingersafe	TW-DA1FB
Full voltage model (use with odd number of contacts) 	Standard	HW-DA1B
	Fingersafe	HW-DA1FB

 All Transformers step down to 6V (use 6V lamp).

Contact Blocks

Style	Part Number	
	1NO	1NC
Standard Exposed Screw 	HW-C10	HW-C01
	HW-C10R (early make)	HW-C01R (late break)
Fingersafe (IP20), CE marked 	HW-F10	HW-F01
	HW-F10R (early make)	HW-F01R (late break)
Dummy Block 	TW-DB	

- 1. Dummy blocks (no contacts) are used with an odd number of contact blocks.
- 2. Use of early and late break contacts creates a make before break function

Switches & Pilot Lights

Display Lights

Relays & Sockets

Timers

Terminal Blocks

Circuit Breakers

Pilot Lights (Assembled)



Assembled Pilot Lights

A P (Q) W 1 (B) (99) (D) - R - (24V)

Function

P: Pilot Light

Bezel Shape

Blank: Octagonal (round lenses)
Q: Square

Series Designation

W: TW Series

Lens Shape

1: Flat
2: Dome

Lens Type

Blank: Standard (ribbed)
B: Engravable (smooth with insert included)

Illumination Circuit

- 99: Full Voltage (lamp determines voltage)
- 126: 120V AC Step Down Transformer
- 246: 240V AC Step Down Transformer
- 486: 480V AC Step Down Transformer

Lamp Voltage

(Full Voltage Units Only)

- 6V: 6V AC/DC
- 12V: 12V AC/DC
- 24V: 24V AC/DC
- 120V: 120V AC (LED only)
- 240V: 240V AC (LED only)

Lens Color Code

- A: Amber
- G: Green
- R: Red
- S: Blue
- W: White
- Y: Yellow

Lamp Type



- Blank: Incandescent
- D: LED



1. Use only when interpreting part numbers. Do not use for developing part numbers.
2. All transformers step down to 6V.

Pilot Lights (Assembled) continued

Assembled Pilot Lights

Style	Type	Voltage	Part Number
 Round Flat	Transformer	120VAC 240VAC 480VAC	APW1126④-② APW1246④-② APW1486④-②
	Full Voltage	—	APW199④-②-③
 Dome	Transformer	120VAC 240VAC 480VAC	APW2126④-② APW2246④-② APW2486④-②
	Full Voltage	—	APW299④-②-③
 Square Flat	Transformer	120VAC 240VAC 480VAC	APQW1B126④-② APQW1B246④-② APQW1B486④-②
	Full Voltage	—	APQW1B99④-②-③

② Lens Color Codes

Color	Code
Amber	A
Green	G
Red	R
Blue	S
White	W
Yellow	Y

③ Full Voltage Codes

Voltage	Code
6V AC/DC	6V
12V AC/DC	12V
24V AC/DC	24V
120V AC	120V (LED only)
240V AC	240V (LED only)

④ Lamp Type Codes

Lamp	Code
Incandescent	Blank
LED	D

- 1. In place of ②, specify the Lens Color Code from table below.
- 2. In place of ③, specify the Full Voltage Code from table below.
- 3. In place of ④, specify the Lamp Type Code from table below.
- 4. For accessories, see page 593.
- 5. For dimensions, see page 595.
- 6. For sub-assembly part numbers, see next page.
- 7. Yellow pilot light comes with white LED.

Pilot Lights (Sub-Assembled)



* Transformer not required for full voltage units.

Operators

Style	Part Number
Round Dome/Flat	APW-199
Square	UPQW-199



Same operator is used for full voltage as for transformer completed units.

Lamps

Style	Voltage	Part Number
	6V AC/DC	LSTD-6Ⓞ
	12V AC/DC	LSTD-1Ⓞ
	24V AC/DC	LSTD-2Ⓞ
	120V AC	LSTD-H2Ⓞ
	240V AC	LSTD-M4Ⓞ
	6V AC/DC	IS-6
	12V AC/DC	IS-12
	24V AC/DC	IS-24



1. In place of Ⓞ, specify the LED color code.
2. The LED contains a current-limiting resistor and a protection diode.
3. Yellow LED not available. Use white LED.

Ⓞ LED/Lens Color Codes

Color	Code
Amber	A
Green	G
Red	R
Blue	S
White	W
Yellow	Y



If clear lens is desired, use white marking lens and remove engraving insert

Transformers

Style	Description	Part Number
	Standard	120V AC 240V AC 480V AC TW-T126B TW-T246B TW-T486B
	Fingersafe	120V AC 240V AC 480V AC TW-F126B TW-F246B TW-F486B



All Transformers step down to 6V (use 6V lamp).

Lenses

Style	Part Number	
	Standard	Engravable
Dome 	APW2LU-Ⓞ	—
Round Flat 	APW1LU-Ⓞ	APW1BLU-Ⓞ
Square Flat 	—	APQW1BLU-Ⓞ



1. In place of Ⓞ, specify the Lens Color Code from table.
2. Standard lenses have a ribbed lens to enhance light dispersion. Marking lenses are smooth and include an engraving insert.

Illuminated Pushbuttons (Assembled)

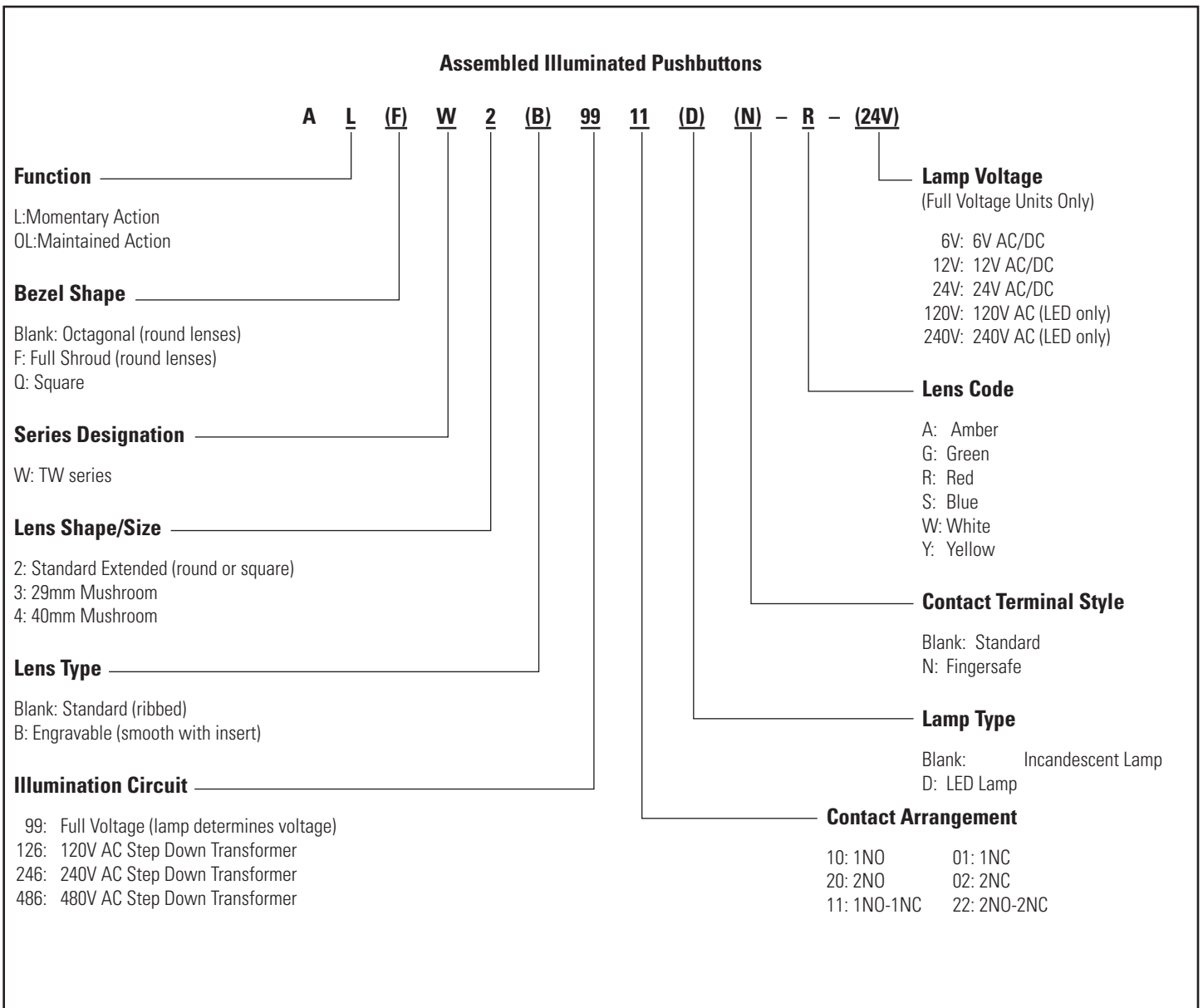

1. Use only when interpreting part numbers. Do not use for developing part numbers.
2. Transformers step down to 6V.

Illuminated Pushbuttons (Assembled)

Illuminated Pushbuttons

Style	Contacts	Part Number		
		Momentary	Maintained	
 Extended Lens	Transformer	1NO-1NC 2NO 2NC	ALW2 ④ 11⑤-② ALW2 ④ 20⑤-② ALW2 ④ 02⑤-②	AOLW2 ④ 11⑤-② AOLW2 ④ 20⑤-② AOLW2 ④ 02⑤-②
	Full Voltage	1NO-1NC 2NO 2NC	ALW29911⑤-②-③ ALW29920⑤-②-③ ALW29902⑤-②-③	AOLW29911⑤-②-③ AOLW29920⑤-②-③ AOLW29902⑤-②-③
 Extended Lens with Full Shroud	Transformer	1NO-1NC 2NO 2NC	ALFW2 ④ 11⑤-② ALFW2 ④ 20⑤-② ALFW2 ④ 02⑤-②	AOLFW2 ④ 11⑤-② AOLFW2 ④ 20⑤-② AOLFW2 ④ 02⑤-②
	Full Voltage	1NO-1NC 2NO 2NC	ALFW29911⑤-②-③ ALFW29920⑤-②-③ ALFW29902⑤-②-③	AOLFW29911⑤-②-③ AOLFW29920⑤-②-③ AOLFW29902⑤-②-③
 ø29mm Mushroom Lens	Transformer	1NO-1NC 2NO 2NC	ALW3 ④ 11⑤-② ALW3 ④ 20⑤-② ALW3 ④ 02⑤-②	AOLW3 ④ 11⑤-② AOLW3 ④ 20⑤-② AOLW3 ④ 02⑤-②
	Full Voltage	1NO-1NC 2NO 2NC	ALW39911⑤-②-③ ALW39920⑤-②-③ ALW39902⑤-②-③	AOLW39911⑤-②-③ AOLW39920⑤-②-③ AOLW39902⑤-②-③
 ø40mm Mushroom Lens	Transformer	1NO-1NC 2NO 2NC	ALW4 ④ 11⑤-② ALW4 ④ 20⑤-② ALW4 ④ 02⑤-②	AOLW4 ④ 11⑤-② AOLW4 ④ 20⑤-② AOLW4 ④ 02⑤-②
	Full Voltage	1NO-1NC 2NO 2NC	ALW49911⑤-②-③ ALW49920⑤-②-③ ALW49902⑤-②-③	AOLW49911⑤-②-③ AOLW49920⑤-②-③ AOLW49902⑤-②-③
 Square Extended	Transformer	1NO-1NC 2NO 2NC	ALQW2B ④ 11⑤-② ALQW2B ④ 20⑤-② ALQW2B ④ 02⑤-②	AOLQW2B ④ 11⑤-② AOLQW2B ④ 20⑤-② AOLQW2B ④ 02⑤-②
	Full Voltage	1NO-1NC 2NO 2NC	ALQW2B9911⑤-②-③ ALQW2B9920⑤-②-③ ALQW2B9902⑤-②-③	AOLQW2B9911⑤-②-③ AOLQW2B9920⑤-②-③ AOLQW2B9902⑤-②-③

② LED/Lens Color Codes

Color	Code
Amber	A
Green	G
Red	R
Blue	S
White	W
Yellow	Y

- 1. Mushroom lenses not available in yellow.
- 2. Yellow pushbutton comes with white LED.

③ Full Voltage Codes

Voltage	Code
6V AC/DC	6V
12V AC/DC	12V
24V AC/DC	24V
120V AC	120V (LED only)
240V AC	240V (LED only)

④ Transformer Voltage Codes

Voltage	Code
120VAC	126
240VAC	246
480VAC	486

- Transformers step down to 6V (use 6V lamp).

⑤ Lamp Type Codes

Lamp	Code
Incandescent	Blank
LED	D

- 1. In place of ②, specify the Lens Color Code (see table). Mushroom lenses not available in yellow.
- 2. In place of ③, specify the Full Voltage Code (lamp voltage) (see table).
- 3. In place of ④, specify the Transformer Voltage Code (see table).
- 4. In place of ⑤, specify the Lamp Type Code from table.
- 5. For sub-assembly part numbers, see next page.
- 6. For accessories, see page 593.
- 7. For dimensions, see page 595.
- 8. Light is independent of switch position.
- 9. Yellow pushbutton comes with white LED.

Switches & Pilot Lights

Display Lights

Relays & Sockets

Timers

Terminal Blocks

Circuit Breakers

Illuminated Pushbuttons (Sub-Assembled)

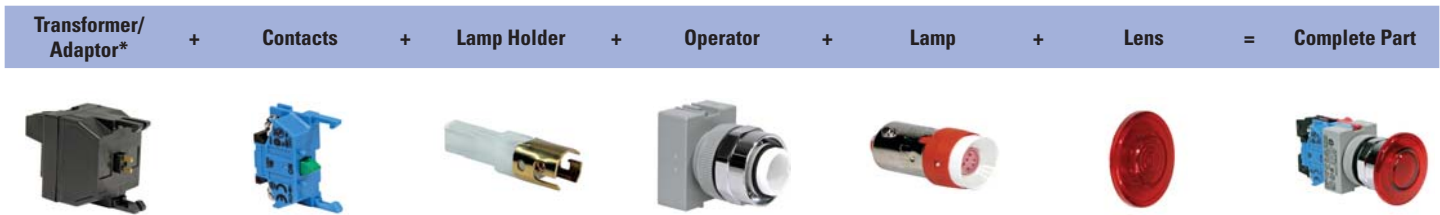

*Not applicable for full voltage units

Operators

Style	Image	Part Number	
		Momentary	Maintained
Extended		ALW-0600	AOLW-0600
Extended with Full Shroud		ALFW-0600	AOLFW-0600
ø29mm/ø40mm Mushroom		ALW3-0600	AOLW3-0600
Square/Extended		ALQW-2B0600	AOLQW-2B0600

Lenses

Style	Image	Part Number	
		Standard	Engravable
Round Extended		ALW2LU-Ⓞ	ALW2BLU-Ⓞ
ø 29mm Mushroom Head*		ALW3LU-Ⓞ	ALW3BLU-Ⓞ
ø 40mm Mushroom Head*		ALW4LU-Ⓞ	ALW4BLU-Ⓞ
Square Extended		—	ALQW2BLU-Ⓞ

- 1. In place of Ⓞ, specify the lens color code from table on the bottom right.
- 2. *Mushroom lens not available in yellow.
- 3. Standard lenses have ribbed pattern, Engravable lenses are smooth and include an engravable insert.

Lamps

Style	Voltage	Part Number
LED	6V AC/DC	LSTD-6Ⓞ
	12V AC/DC	LSTD-1Ⓞ
	24V AC/DC	LSTD-2Ⓞ
	120V AC	LSTD-H2Ⓞ
Incandescent	240V AC	LSTD-M4Ⓞ
	6V AC/DC	IS-6
	12V AC/DC	IS-12
	24V AC/DC	IS-24

- 1. In place of Ⓞ, specify the LED color code.
- 2. The LED contains a current-limiting resistor and a protection diode.

Lamp Circuit Components

Style	Application	Part Number
Short Lamp Holder	Used with a Half-size Transformer and one contact block	TW-LH1
Long Lamp Holder	Used with Full-size Transformer and two contact blocks Used with Half-size Transformer and three contact blocks Used with Full Voltage Adaptor and two contact blocks	TW-LH2
Lead Holder	Used with TW-LH2 holder when using four contact blocks	HW-LH3



Ⓞ LED/Lens Color Codes

Color	Code	Color	Code
Amber	A	Blue	S
Green	G	White	W
Red	R	Yellow	Y

- Yellow LED not available. Use white LED.





Illuminated Pushbuttons (Sub-Assembled) continued

Contact Blocks

Style	Part Number	
	1NO	1NC
Standard Exposed Screw 	HW-C10	HW-C01
	HW-C10R (early make)	HW-C01R (late break)
Fingersafe (IP20), CE marked 	HW-F10	HW-F01
	HW-F10R (early make)	HW-F01R (late break)
Dummy Block 	TW-DB	

- 1. Dummy blocks (no contacts) are used with an odd number of contact blocks.
- 2. Use of early and late break contacts creates a make before break function

Transformers/Full Voltage Modules

Style	Description	Part Number	
Full Size Transformer 	Standard	120V AC 240V AC 480V AC	
	Fingersafe	120V AC 240V AC 480V AC	
	Half Size Transformer 	Standard	120V AC 240V AC
		Fingersafe	120V AC 240V AC
	Full voltage model (use with even number of contacts) 	Standard	120V AC 240V AC
		Fingersafe	120V AC 240V AC
Full voltage model (use with odd number of contacts) 	Standard	120V AC 240V AC	
	Fingersafe	120V AC 240V AC	

 All Transformers step down to 6V (use 6V lamp).

Switches & Pilot Lights

Display Lights

Relays & Sockets

Timers

Terminal Blocks

Circuit Breakers

Non-Illuminated Selector Switches (Assembled)



Assembled Selector Switches

A S W 3 (1) (L) 20 (N) - 304

Function

S: Selector Switch

Series Designation

W: TW Series

Number of Positions

- 2: 2-Position
- 3: 3-Position
- 4: 4-Position
- 5: 5-Position

Spring Return Action

Blank: Maintained

- 1: Spring return from Right (2 or 3 position)
- 2: Spring return from Left (2 or 3 position)
- 3: 2-Way spring return from Left and Right (3 position only)

Circuit Number

(Standard circuits shown on following pages and 585.)

Contacts Terminal Style

Blank: standard
N: Fingersafe (IP20)

Contact Arrangement Code

- 10: 1NO 01: 1NC
- 20: 2NO 02: 2NC
- 40: 4NO 04: 4NC
- 11: 1NO-1NC 22: 2NO-2NC

Operator Style Code

Blank: Knob Operator
L: Lever Operator
K: Key Operator



- 1. Use only when interpreting part numbers. Do not use for developing part numbers.
- 2. Custom contact configurations available.
- 3. Custom key removable codes available.
- 4. Portions of part number inside () are optional.

Non-Illuminated Selector Switches (Assembled) continued

2-Position Selector Switches

Contact	Style				Part Number		
	Mounting	Operator Position			Maintained	Spring Return from Right	Spring Return from Left
		L	R				
1NO	1	0	X	Knob Lever Key	ASW210 ASW2L10 ASW2K10	ASW2110 ASW21L10 ASW21K10	ASW2210 ASW22L10 ASW22K10
	2	0	0				
1NC	1	X	0	Knob Lever Key	ASW201-116 ASW2L01-116 ASW2K01-116	ASW2101-116 ASW21L01-116 ASW21K01-116	ASW2201-116 ASW22L01-116 ASW22K01-116
	2	0	0				
1NO 1NC	1	X	0	Knob Lever Key	ASW211 ASW2L11 ASW2K11	ASW2111 ASW21L11 ASW21K11	ASW2211 ASW22L11 ASW22K11
	2	0	X				
2NO	1	0	X	Knob Lever Key	ASW220 ASW2L20 ASW2K20	ASW2120 ASW21L20 ASW21K20	ASW2220 ASW22L20 ASW22K20
	2	0	X				
2NC	1	X	0	Knob Lever Key	ASW202-104 ASW2L02-104 ASW2K02-104	ASW2102-104 ASW21L02-104 ASW21K02-104	ASW2202-104 ASW22L02-104 ASW22K02-104
	2	X	0				
2NO 2NC	1	0	X	Knob Lever Key	ASW222 ASW2L22 ASW2K22	ASW2122 ASW21L22 ASW21K22	ASW2222 ASW22L22 ASW22K22
	2	X	0				
	3	0	X				
	4	X	0				
2NO 2NC	1	0	X	Knob Lever Key	ASW222-111 ASW2L22-111 ASW2K22-111	ASW2122-111 ASW21L22-111 ASW21K22-111	ASW2222-111 ASW22L22-111 ASW22K22-111
	2	0	X				
	3	X	0				
	4	X	0				



Switches & Pilot Lights

Display Lights

Relays & Sockets

Timers

Terminal Blocks

Circuit Breakers

Non-Illuminated Selector Switches (Assembled) continued

3-Position Selector Switches

Style					Part Number			
Contact	Mounting	Operator Position			Maintained	Spring Return from Right	Spring Return from Left	Spring Return Two-Way
		L	C	R				
2NO	1	X	0	0				
	2	0	0	X				
2NC	1	0	X	X				
	2	X	X	0				
2NO	1	X	0	0				
	2	0	0	X				
2NC	3	0	X	X				
	4	X	X	0				
2NO	1	X	0	X				
	2	X	X	0				
2NC	3	0	X	0				
	4	0	0	X				
2NO	1	0	X	0				
	2	0	0	X				
2NC	3	0	X	0				
	4	0	0	X				
4NO	1	X	0	0				
	2	0	0	X				
4NC	3	X	0	0				
	4	0	0	X				
4NO	1	0	X	X				
	2	X	X	0				
4NC	3	0	X	X				
	4	X	X	0				



- The truth table indicates the operating position of contact block when the operator is switched to that position.
 X = On (closed contacts)
 0 = Off (open contacts)
 X—X = Overlapping Contacts: Remain on (closed contacts) when switch is moved between these two positions.
- All knob and lever selector switches come in black. Other colors are available by ordering the knob or lever separately.
- Every key selector switch uses an identical key. The key is removable in any maintained position.
- Custom contact configurations are available, see page 585.

4-Position Selector Switch

Style						Maintained
Contact	Mounting	Operator Position				Part Number
		1	2	3	4	
2NO	1	X	0	0	0	
	2	0	X	0	0	
2NC	3	0	0	X	0	
	4	0	0	0	X	

5-Position Selector Switch

Style						Maintained	
Contact	Mounting	Operator Position					Part Number
		1	2	3	4	5	
2NO	1	X	0	0	0	0	
	2	0	X	0	0	0	
2NC	3	0	0	0	X	0	
	4	0	0	0	0	X	

Switches & Pilot Lights

Display Lights

Relays & Sockets

Timers

Terminal Blocks



Circuit Breakers

Non-illuminated Selector Switches (Sub-Assembled)



- 1. *Not needed with key type switches.
- 2. †Knob type shown.



Operators

Style	Positions	Description	Part Number	
 <p>Knob/Lever</p>	2	Maintained	ASW200	
		Spring return from right	ASW2100	
		Spring return from left	ASW2200	
	3	Maintained, Cam 1 Maintained, Cam 2 Maintained, Cam 3		ASW300-1 ASW300-2 ASW300-3
			Spring return from right, Cam 1 Spring return from right, Cam 2	ASW3100-1 ASW3100-2
			Spring return from left, Cam 1 Spring return from left, Cam 2	ASW3200-1 ASW3200-2
		Spring return from left/right, Cam 1 Spring return from left/right, Cam 2	ASW3300-1 ASW3300-2	
		4	Maintained, Standard Cam Maintained, Cam 1	ASW400 ASW400-1
			5	Maintained, Standard cam Maintained, Cam 1
 <p>Key</p>	2	Maintained	ASW2K00	
		Spring return from right	ASW21K00	
		Spring return from left	ASW22K00	
	3	Maintained, Cam 1 Maintained, Cam 2 Maintained, Cam 3		ASW3K00-1 ASW3K00-2 ASW3K00-3
			Spring return from right, Cam 1 Spring return from right, Cam 2	ASW31K00-1 ASW31K00-2
			Spring return from left, Cam 1 Spring return from left, Cam 2	ASW32K00-1 ASW32K00-2
		Spring return from left/right, Cam 1 Spring return from left/right, Cam 2	ASW33K00-1 ASW33K00-2	

Handles and Inserts

Style	Part Number
 <p>Knob</p>	ASWHHY-ⓐ
 <p>Lever</p>	ASWHHL-ⓐ
 <p>Color Insert</p>	TW-HC1-ⓐ

Contact Blocks

Style	Part Number	
	1NO	1NC
 <p>Standard Exposed Screw</p>	HW-C10 HW-C10R (early make)	HW-C01 HW-C01R (late break)
 <p>Fingersafe (IP20), CE marked</p>	HW-F10 HW-F10R (early make)	HW-F01 HW-F01R (late break)
 <p>Dummy Block</p>	TW-DB	

- 1. Push rod color code:
Green = NO contact block
Red = NC contact block.
- 2. Dummy blocks (no contacts) are used with an odd number of contact blocks.

Replacement Parts

Key Switch Black Sleeve	AKW2B-B
-------------------------	---------

- 1. Two keys are supplied with every key switch, all are keyed alike, and removable from any maintained position.
- 2. Locking rings are included with all operators. Order knobs, levers, and color inserts separately.
- 3. Different cams produce different contact actions. For details, see contact arrangement charts, page 585.
- 4. Key switch operator supplied with black sleeve.

① Handle/Insert Color Codes

Color	Code
Black*	B
Blue	S
Green	G
Red	R
Yellow	Y
White†	W

- *Color inserts not available in black.
- †Knob and lever not available in white.

Switches & Pilot Lights

Display Lights

Relays & Sockets

Timers

Terminal Blocks

Circuit Breakers

Illuminated Selector Switches (Assembled)



Assembled Illuminated Selector Switches

A SL W 2 (2) 99 11 (D) (N) - (103) - R - (24V)

Function

SL: Illuminated Selector Switch

Series Designation

W: TW series

Number of Positions

2: 2-Position
3: 3-Position

Spring Return Action

Blank: Maintained
1: Spring return from Right
2: Spring return from Left
3: Two-Way spring return from Left and Right

Illumination Circuit

99: Full Voltage (lamp determines voltage)
126: 120V AC Step Down Transformer
246: 240V AC Step Down Transformer
486: 480V AC Step Down Transformer

Lamp Voltage

(Full Voltage Units Only)

6V: 6V AC/DC
12V: 12V AC/DC
24V: 24V AC/DC
120V: 120V AC (LED only)
240V: 240V AC (LED only)

Lens Color Code

A: Amber
G: Green
R: Red
S: Blue
W: White
Y: Yellow

Contact Circuit Number

Standard circuits are listed on the following pages and 585.

Contact Terminal Style

Blank: Standard
N: Fingersafe

Lamp Type

Blank: Incandescent Lamp
D: LED Lamp

Contact Arrangement

10: 1NO	01: 1NC
20: 2NO	02: 2NC
40: 4NO	04: 4NC
11: 1NO-1NC	22: 2NO-2NC

1. Use only when interpreting part numbers. Do not use for developing part numbers.
2. All transformers step down to 6V (use 6V lamp).

Illuminated Selector Switches(Assembled) continued

Illuminated 2-Position Selector Switches

Style					Part Number		
Contact	Mounting	Operator Position		Lamp Circuit Type	Maintained	Spring Return from Right	Spring Return from Left
		L	R				
1NO	1	0	X	Transformer	ASLW2 ① 11④-②	ASLW21 ① 11④-②	ASLW22 ① 11④-②
1NC	2	X	0	Full Voltage	ASLW29911④-②-③	ASLW219911④-②-③	ASLW229911④-②-③
2NO	1	0	X	Transformer	ASLW2 ① 20④-②	ASLW21 ① 20④-②	ASLW22 ① 20④-②
	2	0	X	Full Voltage	ASLW29920④-②-③	ASLW219920④-②-③	ASLW229920④-②-③
2NC	1	X	0	Transformer	ASLW2 ① 02④-104-②	ASLW21 ① 02④-104-②	ASLW22 ① 02④-104-②
	2	X	0	Full Voltage	ASLW29902④-104-②-③	ASLW219902④-104-②-③	ASLW229902④-104-②-③
2NO	1	0	X	Transformer	ASLW2 ① 22④-②	ASLW21 ① 22④-②	ASLW22 ① 22④-②
2NC	2	X	0	Full Voltage	ASLW29922④-②-③	ASLW219922④-②-③	ASLW229922④-②-③
	3	0	X				
	4	X	0				

① Transformer Voltage Codes

Voltage	Code
120VAC	126
240VAC	246
480VAC	486



Transformers step down to 6V (use 6V lamp).

② LED/Lens Color Codes

Color	Code
Amber	A
Green	G
Red	R
Blue	S
White	W
Yellow	Y

Illuminated 3-Position Selector Switches, Maintained and Spring Return from Right

Style					Part Number				
Contact	Mounting	Operator Position			Lamp Circuit Type	Maintained	Spring Return From Right	Spring Return from Left	Spring Return Two-Way
		L	C	R					
2NO	1	X	0	0	Transformer	ASLW3 ① 20④-②	ASLW31 ① 20④-②	ASLW32 ① 20④-②	ASLW33 ① 20④-②
	2	0	0	X	Full Voltage	ASLW39920④-②-③	ASLW319920④-②-③	ASLW329920④-②-③	ASLW339920④-②-③
2NC	1	0	X	X	Transformer	ASLW3 ① 02④-②	ASLW31 ① 02④-②	ASLW32 ① 02④-②	ASLW33 ① 02④-②
	2	X	X	0	Full Voltage	ASLW39902④-②-③	ASLW319902④-②-③	ASLW329902④-②-③	ASLW339902④-②-③
2NO	1	X	0	0	Transformer	ASLW3 ① 22④-②	ASLW31 ① 22④-②	ASLW32 ① 22④-②	ASLW33 ① 22④-②
2NC	2	0	0	X	Full Voltage	ASLW39922④-②-③	ASLW319922④-②-③	ASLW329922④-②-③	ASLW339922④-②-③
	3	0	X	X					
	4	X	X	0					
2NO	1	X	0	X	Transformer	ASLW3 ① 22④-309-②	ASLW31 ① 22④-309-②	ASLW32 ① 22④-309-②	ASLW33 ① 22④-309-②
2NC	2	X	X	0	Full Voltage	ASLW39922④-309-②-③	ASLW319922④-309-②-③	ASLW329922④-309-②-③	ASLW339922④-309-②-③
	3	0	X	0					
	4	0	0	X					
2NO	1	0	X	0	Transformer	ASLW3 ① 22④-310-②	ASLW31 ① 22④-310-②	ASLW32 ① 22④-310-②	ASLW33 ① 22④-310-②
2NC	2	0	0	X	Full Voltage	ASLW39922④-310-②-③	ASLW319922④-310-②-③	ASLW329922④-310-②-③	ASLW339922④-310-②-③
	3	0	X	0					
	4	0	0	X					
4NO	1	X	0	0	Transformer	ASLW3 ① 40④-②	ASLW31 ① 40④-②	ASLW32 ① 40④-②	ASLW33 ① 40④-②
	2	0	0	X	Full Voltage	ASLW39940④-②-③	ASLW319940④-②-③	ASLW329940④-②-③	ASLW339940④-②-③
	3	X	0	0					
	4	0	0	X					
4NC	1	0	X	X	Transformer	ASLW3 ① 04④-②	ASLW31 ① 04④-②	ASLW32 ① 04④-②	ASLW33 ① 04④-②
	2	X	X	0	Full Voltage	ASLW39904④-②-③	ASLW319904④-②-③	ASLW329904④-②-③	ASLW339904④-②-③
	3	0	X	X					
	4	X	X	0					



- In place of ①, specify the Transformer Voltage Code.
- In place of ②, specify the Lens/LED Color Code.
- In place of ③, specify the Full Voltage Code.
- In place of ④ specify Lamp Type Code
- For custom contact configurations, see page 585.
- Light is independent of switch position.
- Yellow selector switch comes with white LED.

③ Full Voltage Codes

Voltage	Code
6V AC/DC	6V
12V AC/DC	12V
24V AC/DC	24V
120V AC	120V (LED only)
240V AC	240V (LED only)

④ Lamp Type Codes

Lamp	Code
Incandescent	Blank
LED	D

Switches & Pilot Lights

Display Lights

Relays & Sockets

Timers

Terminal Blocks

Circuit Breakers

Illuminated Selector Switches (Sub-Assembled)

Transformer* + Contact Block + Operator + Lamp/Lead Holder† + Lamp + Lens = Complete Part



*Full voltage units use a full voltage adaptor (TW-DA1B) instead of a transformer.
 †Lamp holder is not included with operators, order separately.
 Lead holder is used when using 3 or more contact blocks. Order separately.

Operators

Style	Positions	Description	Part Number
	2	Maintained	ASLW200
		Spring return from right	ASLW2100
		Spring return from left	ASLW2200
	3	Maintained, cam 1	ASLW300-1
		Maintained, cam 2	ASLW300-2
		Maintained, cam 3	ASLW300-3
	Spring return from right, cam 1	ASLW3100-1	
	Spring return from right, cam 2	ASLW3100-2	
	Spring return from left, cam 1	ASLW3200-1	
	Spring return from left, cam 2	ASLW3200-2	
	Spring return from left/right, cam 1	ASLW3300-1	
Spring return from left/right, cam 2	ASLW3300-2		

Different cams produce different contact action. For details, see Contact Arrangements on page 585.

Lenses (Knobs)

Description	Part Number
Knob	ASLWLU-Ⓢ

In place of Ⓢ, specify the lens color code from table.

Lamps

Style	Voltage	Part Number
	6V AC/DC	LSTD-6Ⓢ
	12V AC/DC	LSTD-1Ⓢ
	24V AC/DC	LSTD-2Ⓢ
	120V AC	LSTD-H2Ⓢ
	240V AC	LSTD-M4Ⓢ
	6V AC/DC	IS-6
	12V AC/DC	IS-12
	24V AC/DC	IS-24

1. In place of Ⓢ, specify the LED color code.
 2. The LED contains a current-limiting resistor and a protection diode.



Ⓢ LED/Lens Color Codes

Color	Code
Amber	A
Green	G
Red	R
Blue	S
White	W
Yellow	Y

Yellow LED not available. Use white LED



Illuminated Selector Switches (Sub-Assembled) continued

Contact Blocks

Style	Part Number	
	1NO	1NC
Standard Exposed Screw 	HW-C10 HW-C10R (early make)	HW-C01 HW-C01R (late break)
Fingersafe (IP20), CE marked 	HW-F10 HW-F10R (early make)	HW-F01 HW-F01R (late break)
Dummy Block 	TW-DB	

-  1. Dummy blocks (no contacts) are used with an odd number of contact blocks.
- 2. Use of early and late break contacts creates a make before break function

Lamp Circuit Components

Style	Application	Part Number
Short Lamp Holder 	Used with a Half-size Transformer and one contact block	TW-LH1
Long Lamp Holder 	Used with Full-size Transformer and two contact blocks Used with Half-size Transformer and three contact blocks Used with Full Voltage Adaptor and two contact blocks	TW-LH2
Lead Holder 	Used with TW-LH2 holder when using four contact blocks	HW-LH3

Transformers/Full Voltage Modules

Style	Description	Part Number	
Full Size Transformer 	120V AC	TW-T126B	
	Standard	240V AC	TW-T246B
		480V AC	TW-T486B
		120V AC	TW-F126B
	Fingersafe	240V AC	TW-F246B
480V AC		TW-F486B	
Half Size Transformer 	120V AC	TW-T126SB	
	240V AC	TW-T246SB	
Full voltage model (use with even number of contacts) 	Standard	TW-DA1B	
	Fingersafe	TW-DA1FB	
Full voltage model (use with odd number of contacts) 	Standard	HW-DA1B	
	Fingersafe	HW-DA1FB	

-  All Transformers step down to 6V (use 6V lamp).

Switches & Pilot Lights

Display Lights

Relays & Sockets

Timers

Terminal Blocks

Circuit Breakers

Contact Arrangement Charts

How to Read Contact Arrangement Charts

To determine contact block mounting position, first make sure the selector switch is oriented as shown on the right

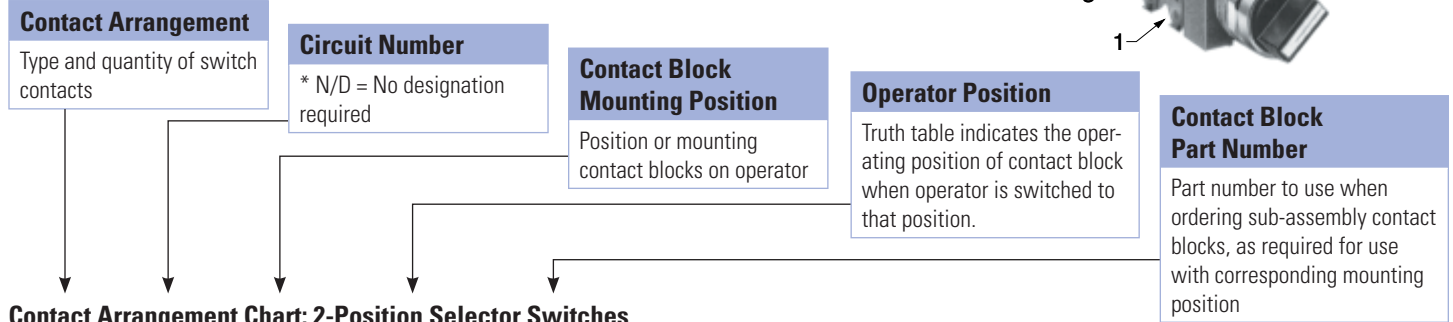
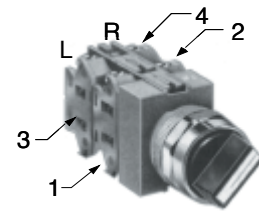

Contact Arrangement Chart: 2-Position Selector Switches

Style		Mounting Position	Operator Position		Contact Block Part Number	Description	Operator Part Number		
Contact	Circuit Number		L	R			Maintained	Spring Ret. from Rt.	Spring Ret. from Lt.
1NO	N/D	1	0	X	HW-C10	Knob/Lever Key	ASW200	ASW2100	ASW2200
		2	0	0	TW-DB		ASW2K00	ASW21K00	ASW22K00
1NC	116	1	X	0	HW-C01	Knob/Lever Key	ASW200	ASW2100	ASW2200
		2	0	0	TW-DB		ASW2K00	ASW21K00	ASW22K00
1NO 1NC	N/D	1	0	X	HW-C10	Knob/Lever Key	ASW200	ASW2100	ASW2200
		2	X	0	HW-C01		ASW2K00	ASW21K00	ASW22K00
	103	1	X	0	HW-C01	Knob/Lever Key	ASW200	ASW2100	ASW2200
		2	0	X	HW-C10		ASW2K00	ASW21K00	ASW22K00
1NO-EM 1NC-LB	600	1	0	X	HW-C10R	Knob/Lever Key	ASW200	ASW2100	ASW2200
		2	X	0	HW-C01R		ASW2K00	ASW21K00	ASW22K00
	601	1	X	0	HW-C01R	Knob/Lever Key	ASW200	ASW2100	ASW2200
		2	0	X	HW-C10R		ASW2K00	ASW21K00	ASW22K00
2NO	N/D	1	0	X	HW-C10	Knob/Lever Key	ASW200	ASW2100	ASW2200
		2	0	X	HW-C10		ASW2K00	ASW21K00	ASW22K00
2NC	104	1	X	0	HW-C01	Knob/Lever Key	ASW200	ASW2100	ASW2200
		2	X	0	HW-C01		ASW2K00	ASW21K00	ASW22K00
2NO 2NC	N/D	1	0	X	HW-C10	Knob/Lever Key	ASW200 ASW2K00 ASLW200	ASW2100 ASW21K00 ASLW2100	ASW2200 ASW22K00 ASLW2200
		2	X	0	HW-C01				
		3	0	X	HW-C10				
		4	X	0	HW-C01				
	111	1	0	X	HW-C10	Knob/Lever Key	ASW200 ASW2K00 ASLW200	ASW2100 ASW21K00 ASLW2100	ASW2200 ASW22K00 ASLW2200
		2	0	X	HW-C10				
		3	X	0	HW-C01				
		4	X	0	HW-C01				

1. NO-EM, NC-LB = Early Make, Late Break.
 N/D = No circuit number designation required in assembled selector switch part number.
 2. X = On (closed contacts) 0 = Off (Open contacts)

Switches & Pilot Lights

Display Lights

Relays & Sockets

Timers

Terminal Blocks

Circuit Breakers

Contact Arrangement Chart: 3-Position Selector Switches

Style	Contact	Circuit Number	Mounting Position	Operator Position			Contact Block Part Number	Description	Operator Part Number			
				L	C	R			Maintained	Spring Return from Right	Spring Return from Left	Two-Way
1NO 1NC	202	1	X	0	0	HW-C10	Knob/Lever Key	ASW300-1 ASW3K00-1 ASLW300-1	ASW3100-1 ASW31K00-1 ASLW3100-1	ASW3200-1 ASW32K00-1 ASLW3200-1	ASW3300-1 ASW33K00-1 ASLW3300-1	
		2	X	X	0	HW-C01	Illuminated Knob					
	203	1	0	X	X	HW-C01	Knob/Lever Key	ASW300-1 ASW3K00-1 ASLW300-1	ASW3100-1 ASW31K00-1 ASLW3100-1	ASW3200-1 ASW32K00-1 ASLW3200-1	ASW3300-1 ASW33K00-1 ASLW3300-1	
		2	0	0	X	HW-C10	Illuminated Knob					
	302	1	X	0	X	HW-C10	Knob/Lever Key	ASW300-2 ASW3K00-2 ASLW300-2	ASW3100-2 ASW31K00-2 ASLW3100-2	ASW3200-2 ASW32K00-2 ASLW3200-2	ASW3300-2 ASW33K00-2 ASLW3300-2	
		2	X	X	0	HW-C01	Illuminated Knob					
	303	1	0	X	0	HW-C01	Knob/Lever Key	ASW300-2 ASW3K00-2 ASLW300-2	ASW3100-2 ASW31K00-2 ASLW3100-2	ASW3200-2 ASW32K00-2 ASLW3200-2	ASW3300-2 ASW33K00-2 ASLW3300-2	
		2	0	0	X	HW-C10	Illuminated Knob					
	2NO	N/D	1	X	0	0	HW-C10	Knob/Lever Key	ASW300-1 ASW3K00-1 ASLW300-1	ASW3100-1 ASW31K00-1 ASLW3100-1	ASW3200-1 ASW32K00-1 ASLW3200-1	ASW3300-1 ASW33K00-1 ASLW3300-1
			2	0	0	X	HW-C10	Illuminated Knob				
		301	1	X	0	X	HW-C10	Knob/Lever Key	ASW300-2 ASW3K00-2 ASLW300-2	ASW3100-2 ASW31K00-2 ASLW3100-2	ASW3200-2 ASW32K00-2 ASLW3200-2	ASW3300-2 ASW33K00-2 ASLW3300-2
			2	0	0	X	HW-C10	Illuminated Knob				
2NC	304	1	0	X	0	HW-C01	Knob/Lever Key	ASW300-2 ASW3K00-2 ASLW300-2	ASW3100-2 ASW31K00-2 ASLW3100-2	ASW3200-2 ASW32K00-2 ASLW3200-2	ASW3300-2 ASW33K00-2 ASLW3300-2	
		2	X	X	0	HW-C01	Illuminated Knob					
	N/D	1	0	X	X	HW-C01	Knob/Lever Key	ASW300-1 ASW3K00-1 ASLW300-1	ASW3100-1 ASW31K00-1 ASLW3100-1	ASW3200-1 ASW32K00-1 ASLW3200-1	ASW3300-1 ASW33K00-1 ASLW3300-1	
		2	X	X	0	HW-C01	Illuminated Knob					
2NO 2NC	N/D	1	X	0	0	HW-C10	Knob/Lever Key Illuminated Knob	ASW300-1 ASW3K00-1 ASLW300-1	ASW3100-1 ASW31K00-1 ASLW3100-1	ASW3200-1 ASW32K00-1 ASLW3200-1	ASW3300-1 ASW33K00-1 ASLW3300-1	
		2	0	0	X	HW-C10						
		3	0	X	X	HW-C01						
		4	X	X	0	HW-C01						
	210	1	0	X	X	HW-C01	Knob/Lever Key Illuminated Knob	ASW300-1 ASW3K00-1 ASLW300-1	ASW3100-1 ASW31K00-1 ASLW3100-1	ASW3200-1 ASW32K00-1 ASLW3200-1	ASW3300-1 ASW33K00-1 ASLW3300-1	
		2	0	0	X	HW-C10						
		3	0	X	X	HW-C01						
		4	0	0	X	HW-C10						
	308	1	X	0	X	HW-C10	Knob/Lever Key Illuminated Knob	ASW300-2 ASW3K00-2 ASLW300-2	ASW3100-2 ASW31K00-2 ASLW3100-2	ASW3200-2 ASW32K00-2 ASLW3200-2	ASW3300-2 ASW33K00-2 ASLW3300-2	
		2	X	X	0	HW-C01						
		3	X	0	X	HW-C10						
		4	X	X	0	HW-C01						
	309	1	X	0	X	HW-C10	Knob/Lever Key Illuminated Knob	ASW300-2 ASW3K00-2 ASLW300-2	ASW3100-2 ASW31K00-2 ASLW3100-2	ASW3200-2 ASW32K00-2 ASLW3200-2	ASW3300-2 ASW33K00-2 ASLW3300-2	
		2	X	X	0	HW-C01						
		3	0	X	0	HW-C01						
		4	0	0	X	HW-C10						
310	1	0	X	0	HW-C01	Knob/Lever Key Illuminated Knob	ASW300-2 ASW3K00-2 ASLW300-2	ASW3100-2 ASW31K00-2 ASLW3100-2	ASW3200-2 ASW32K00-2 ASLW3200-2	ASW3300-2 ASW33K00-2 ASLW3300-2		
	2	0	0	X	HW-C10							
	3	0	X	0	HW-C01							
	4	0	0	X	HW-C10							

Switches & Pilot Lights

Display Lights

Relays & Sockets

Timers

Terminal Blocks

Circuit Breakers

- Each operator sub-assembly is available as a "-1" and a "-2" for 3-position selector switches. The internal cam of a "-1" is different from that of a "-2". This results in designated combinations of open and closed contacts in the various operator positions.
- N/D = No circuit number designation required in assembled part number.
- X = On (closed contacts) 0 = Off (open contacts). X X Overlapping contacts remain on (closed) when switch is moved between these two positions.

Contact Arrangement Chart: 3-Position Selector Switches

Style		Mounting Position	Operator Position			Contact Block Part Number	Description	Operator Part Number			
Contact	Circuit Number		L	C	R			Maintained	Spring Return from Right	Spring Return from Left	Two-Way
4NO	N/D	1	X	0	0	HW-C10	Knob/Lever Key Illuminated Knob	ASW300-1 ASW3K00-1 ASLW300-1	ASW3100-1 ASW31K00-1 ASLW3100-1	ASW3200-1 ASW32K00-1 ASLW3200-1	ASW3300-1 ASW33K00-1 ASLW3300-1
		2	0	0	X	HW-C10					
		3	X	0	0	HW-C10					
		4	0	0	X	HW-C10					
	305	1	X	0	X	HW-C10	Knob/Lever Key Illuminated Knob	ASW300-2 ASW3K00-2 ASLW300-2	ASW3100-2 ASW31K00-2 ASLW3100-2	ASW3200-2 ASW32K00-2 ASLW3200-2	ASW3300-2 ASW33K00-2 ASLW3300-2
		2	0	0	X	HW-C10					
		3	X	0	X	HW-C10					
		4	0	0	X	HW-C10					
4NC	N/D	1	0	X	X	HW-C01	Knob/Lever Key Illuminated Knob	ASW300-1 ASW3K00-1 ASLW300-1	ASW3100-1 ASW31K00-1 ASLW3100-1	ASW3200-1 ASW32K00-1 ASLW3200-1	ASW3300-1 ASW33K00-1 ASLW3300-1
		2	X	X	0	HW-C01					
		3	0	X	X	HW-C01					
		4	X	X	0	HW-C01					
	314	1	0	X	0	HW-C01	Knob/Lever Key Illuminated Knob	ASW300-2 ASW3K00-2 ASLW300-2	ASW3100-2 ASW31K00-2 ASLW3100-2	ASW3200-2 ASW32K00-2 ASLW3200-2	ASW3300-2 ASW33K00-2 ASLW3300-2
		2	X	X	0	HW-C01					
		3	0	X	0	HW-C01					
		4	X	X	0	HW-C01					

- 1. Each operator sub-assembly is available as a "-1" and a "-2" for 3-position selector switches. The internal cam of a "-1" is different from that of a "-2". This results in designated combinations of open and closed contacts in the various operator positions.
- 2. N/D = No circuit number designation required in assembled part number.
- 3. X = On (closed contacts) 0 = Off (open contacts). X X Overlapping contacts remain on (closed) when switch is moved between these two positions.

Switches & Pilot Lights

Display Lights

Relays & Sockets

Timers

Terminal Blocks

Circuit Breakers

Custom Selector Switch Building Guide

To build a custom selector switch, follow these steps.

Step 1

How many positions of the switch are needed?

of positions
(2, 3, 4, 5)

Step 2

How many contacts should there be?

of isolated contacts
(maximum 6)

Step 3

Fill in the Truth Table

(X = closed, 0 = open)

		Knob Position				
		1	2	3	4	5
Contacts	1					
	2					
	3					
	4					
	5					
	6					

Step 4

If building a 2 position selector, skip this step. (2 position selectors have only one cam)

If building a 3, 4, or 5 position selector, determine appropriate cam as follows:

- Look at Row 1 from above table and locate an identical row in the operator truth tables (See next page).
- Repeat for all rows. The user must find one operator that contains all rows from above table.
- Record the operator cam version.

Step 5

Build by placing appropriate contact in appropriate mounting position for each desired row on operator cam truth table. "L" and "R" refer to mounting on left or right side of operator as viewed from the front of the panel.

Step 6

Develop an assembly part number (if necessary) as follows: follow standard numbering nomenclature for selector switches (see pages 577 or 581. In place of the "Circuit Number" indicate the cam number and contact arrangement as such ASW322-3-OELCSS, where "3" is the cam number, and contact arrangement "OELCXX" calls out individual contact mounting locations in order (see diagram above). O=NO, C=NC, E=NO-EM, L=NC-LB, X= no contact. Part number must designate all 6 possible mounting locations.

Mounting Positions

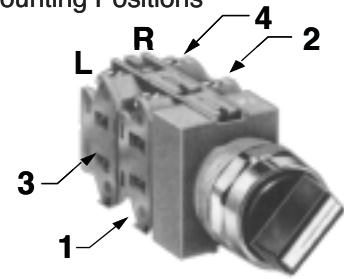

Switches & Pilot Lights

Display Lights

Relays & Sockets

Timers

Terminal Blocks

Circuit Breakers



Caution: Before putting any custom selector switch into use, the user should use an ohmmeter to test for desired performance.
1. For Operator Truth Tables, see next page.

Operator Truth Tables

Use the following tables to build custom selector switches.

2 Position Selector Switches

	Contact	Mounting Position	Operator Position	
			Left	Right
			ASW200 ASLW200 ASW2K00	HW-C10 (NO)
R	0	X		
HW-C01 (NC)	L	X		0
	R	X		0
HW-C10R (NO-EM)	L	0		X
	R	0		X
HW-C01R (NC-LB)	L	X	0	
	R	X	0	

3 Position Selector Switches

	Contact	Mounting Position	Operator Position		
			Left	Center	Right
			ASW300-1 ASW3K00-1 ASLW300-1	HW-C10 (NO)	L
R	0	0			X
HW-C01 (NC)	L	0		X	X
	R	X		X	0
HW-C10R (NO-EM)	L	X		0	0
	R	0		0	X
HW-C01R (NC-LB)	L	0	X	X	
	R	X	X	0	

	Contact	Mounting Position	Operator Position		
			Left	Center	Right
			ASW300-2 ASW3K00-2 ASLW300-2	HW-C10 (NO)	L
R	0	0			X
HW-C01 (NC)	L	0		X	0
	R	X		X	0
HW-C10R (NO-EM)	L	X		0	X
	R	0		0	X
HW-C01R (NC-LB)	L	0	X	0	
	R	X	X	0	

	Contact	Mounting Position	Operator Position		
			Left	Center	Right
			ASW300-3 ASW3K00-3 ASLW300-3	HW-C10 (NO)	L
R	0	0			X
HW-C01 (NC)	L	0		X	0
	R	0		X	0
HW-C10R (NO-EM)	L	X		0	X
	R	X		0	X
HW-C01R (NC-LB)	L	0	X	X	
	R	X	X	0	

4 Position Selector Switches

	Contact	Mounting Position	Operator Position			
			1	2	3	4
			ASW400	HW-C10 (NO)	L	X
R	0	X			0	0
HW-C01 (NC)	L	0		X	X	X
	R	X		0	X	X
HW-C10R (NO-EM)	L	X		0	0	0
	R	0		X	0	0
HW-C01R (NC-LB)	L	0	X	X	X	
	R	X	0	X	X	

	Contact	Mounting Position	Operator Position			
			1	2	3	4
			ASW400-1	HW-C10 (NO)	L	X
R	0	0			0	X
HW-C01 (NC)	L	0		0	X	0
	R	0		X	0	0
HW-C10R (NO-EM)	L	X		X	0	X
	R	X		0	X	X
HW-C01R (NC-LB)	L	0	X	X	X	
	R	X	X	X	0	

5 Position Selector Switches

	Contact	Mounting Position	Operator Position				
			1	2	3	4	5
			ASW500	HW-C10 (NO)	L	X	0
R	0	X			0	0	0
HW-C01 (NC)	L	0		0	X	X	X
	R	0		0	0	X	X
HW-C10R (NO-EM)	L	X		0	0	0	0
	R	0		X	0	0	0
HW-C01R (NC-LB)	L	0	X	X	X	X	
	R	X	0	X	X	X	

	Contact	Mounting Position	Operator Position				
			1	2	3	4	5
			ASW500-1	HW-C10 (NO)	L	X	0
R	0	0			0	0	X
HW-C01 (NC)	L	0		0	0	X	0
	R	0		X	0	0	0
HW-C10R (NO-EM)	L	X		X	X	0	X
	R	X		0	X	X	X
HW-C01R (NC-LB)	L	0	X	X	X	X	
	R	X	X	X	X	0	

Switches & Pilot Lights

Display Lights

Relays & Sockets

Timers

Terminal Blocks

Circuit Breakers

Nameplates – TW Series

Faceplates

	NWAL	NWAQL	NWAS	EMERGENCY STOP
	Part Number			
Nameplate (blank)	NWAL-OB (black) NWAL-OR (red)	NWAQL-OB (black) NWAQL-OR (red)	NWAS-OB	NWAR-0
Nameplate (engraved)	NWAL-⓪	NWAQL-⓪	NWAS-⓪	NWAR-27†

- 1. In place of ⓪, insert either the Standard Legend Code from table below or custom engraving delimited by “ ”.
- 2. Standard engravings are available at no charge.
- 3. NWAR-27 comes marked “Emergency Stop” as shown in drawing.

Standard Legend Codes

Pushbuttons				Pushbuttons/Selector Switches				Selector Switches	
Legend	Code	Legend	Code	Legend	Code	Legend	Code	Legend	Code
AUTO	101	OPEN	116	AUTO-MAN	201			AUTO-MAN-OFF	301
CLOSE	102	OUT	117	CLOSE-OPEN	202			AUTO-OFF-MAN	302
DOWN	103	RAISE	118	DOWN-UP	203			CLOSE-OFF-OPEN	303
EMERG.STOP	104	RESET	119	FAST-SLOW	204			DOWN-OFF-SLOW	304
FAST	105	REVERSE	120	FOR-REV	205	REV-FOR	216	FAST-OFF-SLOW	305
FORWARD	106	RUN	121	HAND-AUTO	206	RUN-JOG	217	FOR-OFF-REV	306
HAND	107	SLOW	122	HIGH-LOW	207	RUN-SAFE	218	LEFT-OFF-RIGHT	307
HIGH	108	START	123	JOG-RUN	208	SAFE-RUN	219	LOWER-OFF-RAISE	308
IN	109	STOP	124	LEFT-RIGHT	209	SLOW-FAST	220	OFF-MAN-AUTO	309
INCH	110	STOP	125	LOWER-RAISE	210	START-STOP	221	OFF-SLOW-FAST	310
JOG	111	TEST	126	MAN-AUTO	211	STOP-START	222	OFF-1-2	311
LOW	112	UP	127	OFF-ON	212	UP-DOWN	223	OPEN-OFF-CLOSE	312
LOWER	113	I (Int'l On)	150	ON-OFF	213			SLOW-OFF-FAST	313
OFF	114	O (Int'l Off)	151	OPEN-CLOSE	214			SUMMER-OFF-WINTER	314
ON	115	EMO	152	RAISE-LOWER	215			UP-OFF-DOWN	315
								1-OFF-2	316
								HAND-OFF-AUTO	317

- 1. To order engraved nameplates, add legend code to nameplate part number. Character height based on the number of characters and size of nameplate. Standard character size is 3/16".
- 2. Nameplates with standard legends are the same list price as blank nameplates.

Nameplate Order Form on next page.

Switches & Pilot Lights

Display Lights

Relays & Sockets

Timers

Terminal Blocks

Circuit Breakers

Switch Engraving Order Form – TW Series

Copy this order form and use it to specify Letter Height, Maximum Number of Lines and Text to be engraved.

To insure engraving accuracy, fax it to your IDEC representative or Distributor.

Your Company: _____
 Name: _____
 Address: _____
 PO: _____

Telephone: _____
 Fax: _____
 Email: _____
 Part Number to be Engraved: _____

Please check one of the boxes below to indicate your choice of engraving options:



ø29mm, ø40mm Mushroom Head

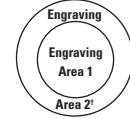

	# of Lines	Letter Height	Max. Characters Per Line
<input type="checkbox"/>	1	5/32	6
<input type="checkbox"/>		1/8	6
<input type="checkbox"/>	2	5/32	6
<input type="checkbox"/>		1/8	5
<input type="checkbox"/>	3	1/8	6
<input type="checkbox"/>	4	3/32	5

	# of Lines	Letter Height	Max. Characters Per Line
<input type="checkbox"/>	1	5/32	5
<input type="checkbox"/>		1/8	6
<input type="checkbox"/>	2	5/32	5
<input type="checkbox"/>		1/8	6
<input type="checkbox"/>	3	1/8	5
<input type="checkbox"/>	4	3/32	5

		# of Lines	Letter Height	Max. Characters Per Line
<input type="checkbox"/>	Engraving Area 1	1	5/32	5
<input type="checkbox"/>			1/8	5
<input type="checkbox"/>	Engraving Area 2	1	5/32	7
<input type="checkbox"/>			1/8	7



- Above mentioned specifications hold true for standard size pushbuttons (round and square).
- *Engraving Area 2 can be engraved for 40mm mushroom Head non-Illuminated push button only.
- Engraving is done on the button itself for non-Illuminated push buttons and on marking plate for illuminated push buttons and pilot lights.
- Please enter text exactly how you want it engraved, take care to emphasize capital or small letters.

Enter text to be engraved:

Line 1: _____
 Line 2: _____
 Line 3: _____
 Line 4: _____

Sample Letter Sizes

1/8 Letters: **OPEN**
 5/32 Letters: **OPEN**

For IDEC Internal Use Only:

Work Order #: _____

Accessories

TW Series Accessories

Appearance	Description/Usage	Part Number
 Lamp Removal Tool	Rubber tool used to install or remove LED's and incandescent lamps	OR-55
 Contact Block Remover	Used to remove contact blocks, transformers, lenses, and adaptors. Can also be used to determine panel thickness adjustment.	TW-KC1
 Nut Locking Wrench	Used in OR-14 locking wrench to tighten locking nuts inside square bezel	TW-KQ2
 Metal Bezel	Chrome plated bezels tighten onto operator (replacement for damaged bezels)	Standard octagonal units (chrome-pl.) AW-R8
		Full shroud octagonal units (chrome-pl.) AW-RF8
		Full shroud mushroom head units Ø 40mm AW-G4
 Plastic Bezel	Black plastic bezels for square buttons (replacement for damaged bezels)	Round flush units (black plastic) AW-RP1B
		Round extended units (black plastic) AW-FP1B
		Square units (black plastic) AW-Q1B
		Square units with full shroud (black plastic) AW-QF1B
 Boot/Cover	Used to cover and protect pushbuttons	Waterproof lens cover for square pilot lights APW00LN
		Waterproof lens cover for square illuminated buttons APW00L
		Clear boot for round flush units OC-31
		Clear boot for round extended units OC-32
		In place of asterisk, specify Rubber Boot color: B (black), G (green), R (red), Y (yellow) - (nitril rubber) OCW-11
 Anti-Rotation Ring	Ring to prevent operator base from rotating in the mounting hole. Used when nameplate is not used	OGL-31
 Mounting Hole Plug	Black rubber plug fills unused mounting holes in panel.	OB-31
 Metallic Mounting Hole Plug	For plugging unused mounting holes in the panel. Tighten the attached locking ring to a torque of 12 kfg-cm maximum Degree of protection: IP66	LW9Z-BM
 Replacement Keys	Pair of keys (#0)	TW-SK
 Replacement Black Sleeve for Keyswitch		AKW2B-B
 Metal Button Guard	Used on flush buttons to prevent inadvertent actuation	OLW-C

Switches & Pilot Lights

Display Lights

Relays & Sockets

Timers

Terminal Blocks

Circuit Breakers





Switches & Pilot Lights

Appearance	Description/Usage	Part Number	
 <p>Terminal Tab Adaptor</p>	Quick-connect terminals	#250 (17/64" x 3/64") single tab TW-FA1	
 <p>Lock-out Adaptor</p>	Used to provide lock-out protection for pushbuttons and knob selector switches: • Up to Ø 40mm mushroom head size (Padlock not included.)	HW9Z-KL1	
 <p>TW to TWTD Adaptor</p>	Used to mount TW series control unit (except square units) Ø 7/8" (22mm) into a Ø 1-13/64" (30mm) panel cut-out.	TWN-A1R8	
 <p>Replacement Marking Plates</p>	White plastic engraving plate for use on all illuminated units (included in each lens). May be used to capture printed mylar insert (not supplied by IDEC) under lens face.	Round Pushbutton (Ø14mm)	ALW2B
		Round Pilot Light (Ø 14mm)	APW2B
		Mushroom Pushbutton (Ø 14mm)	ALW3B
		Square Pilot Light (q 21mm)	APQW1B
		Square Pushbutton (q 21mm)	ALQW2B

Display Lights

Relays & Sockets

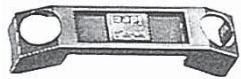
Fingersafe Covers for TW Series

Appearance	Description	Used with	Part Number
	Fingersafe terminal cover, adds 6mm to overall depth	APW and UPQW full voltage pilot lights	APS-PVL
	Fingersafe terminal cover, adds 3.5mm to overall depth. One required for each contact, only for rear-most terminals	Non-illuminated pushbuttons and selectors	HW-VL2
	Fingersafe terminal cover, adds 3mm to overall depth	APW and UPQW transformer pilot lights, and illuminated pushbuttons and illuminated selectors	HW-VL3
	Fingersafe terminal cover for contacts.	Full voltage illuminated pushbuttons and selectors	HW-VL4
	Fingersafe terminal cover for full voltage adaptor, adds 3 mm to depth	Full voltage illuminated pushbuttons and selectors	HW-VL5
	Fingersafe terminal cover for half size transformer adaptor, adds 3 mm to depth	Illuminated pushbuttons and selectors	HW-VL6

Timers

Terminal Blocks

Circuit Breakers

Dimensions

Pushbuttons

Flush

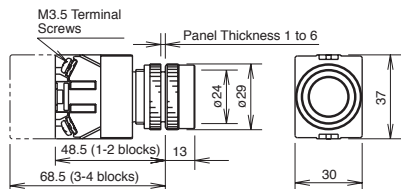

Extended

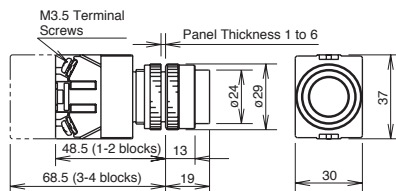

Extended with Full Shroud

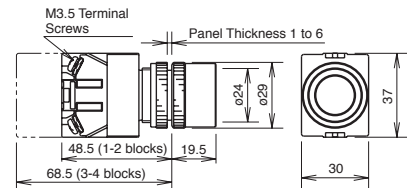

29mm Mushroom

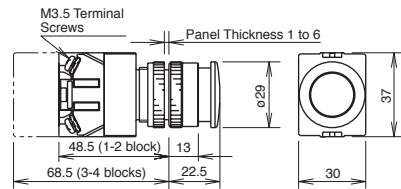

40mm Mushroom

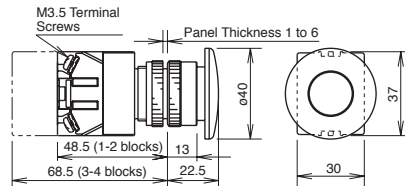

Mushroom with Full Shroud

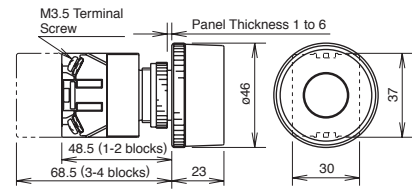

29mm Push-Lock-Turn-Reset

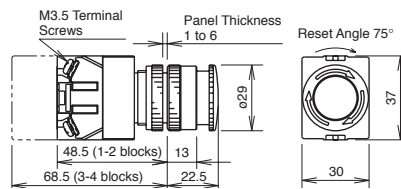

40mm Push-Lock-Turn-Reset

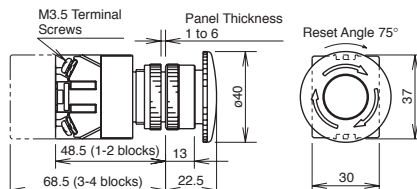

Keylock Push On/Off

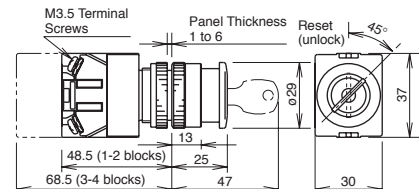

40mm Pushlock Key reset

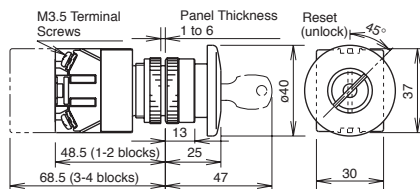

40mm Push-Pull

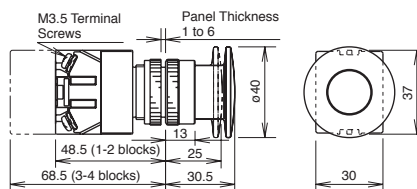

Square Flush

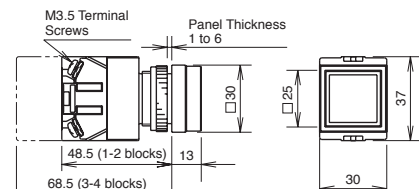

Square Extended

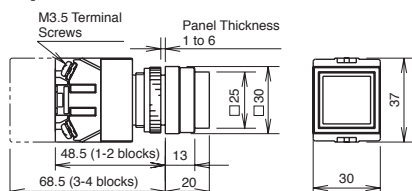

Selector Switches

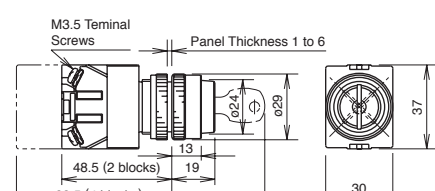
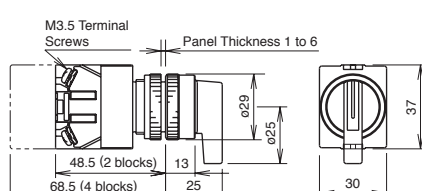
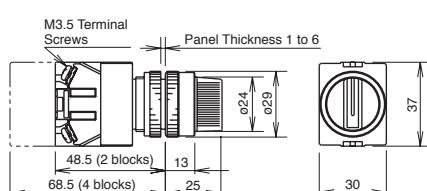

Switches & Pilot Lights

Display Lights

Relays & Sockets

Timers

Terminal Blocks

Circuit Breakers

Dimensions continued

Illuminated Pushbuttons

Extended

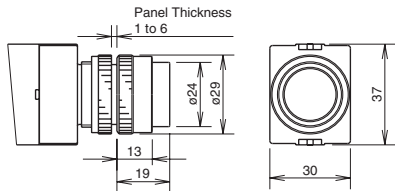

Marking plate: ø15.5mm

Extended with Full Shroud

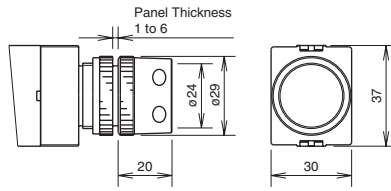

Marking plate: ø15.5mm

Square Extended

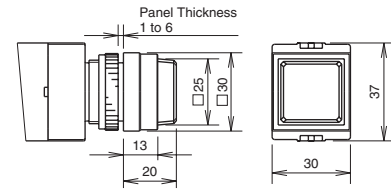

Marking plate: □21mm

29mm Push-Turn-Reset

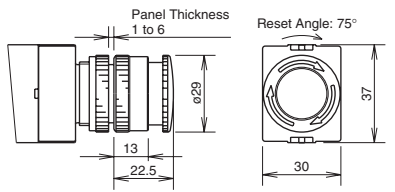

Marking plate: ø13.9mm

40mm Push-Turn-Reset

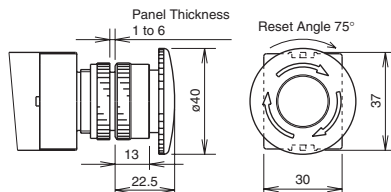

Marking plate: ø13.9mm

Mushroom

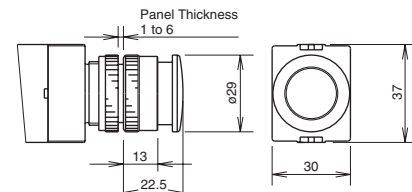

Marking plate: ø13.9mm

Push-Pull

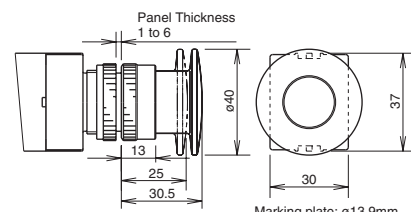

Marking plate: ø13.9mm

Illuminated Selector Switches

1 Contact Block with Full Voltage Adaptor

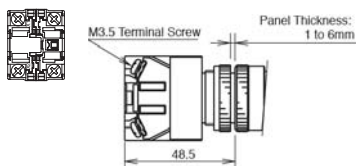

Transformer (2 blocks)

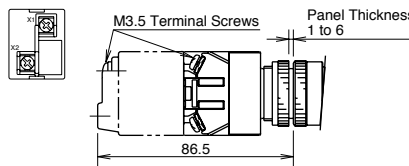

1 Contact Block with Half Size Transformer

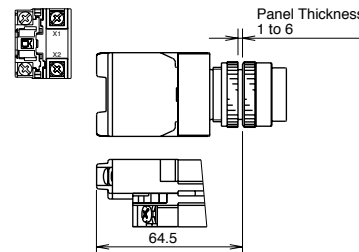

2 Contact Blocks with Full Voltage Adaptor

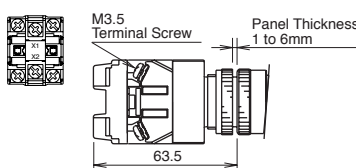

Transformer (4 blocks)

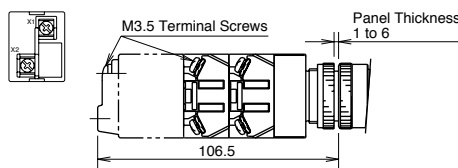

2 Contact Blocks with Half Size Transformer

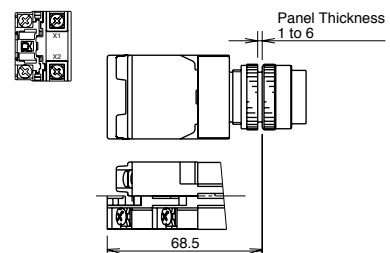

3 Contact Blocks with Full Voltage Adaptor

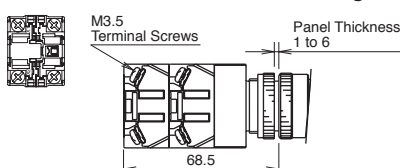

4 Contact Blocks with Full Voltage Adaptor

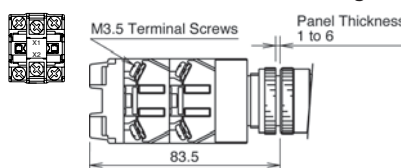

3 Contact Blocks with Half Size Transformer

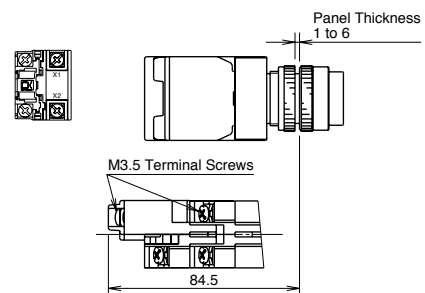

Switches & Pilot Lights

Display Lights

Relays & Sockets

Timers

Terminal Blocks

Circuit Breakers

Dimensions continued

Pilot Lights

Round Flush APW1 Full Voltage

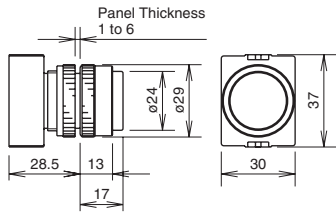

Round Flush APW1 Transformer

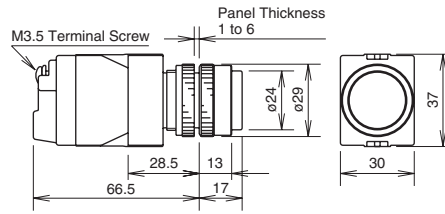

Round Flush Marking Type APW1B Full Voltage

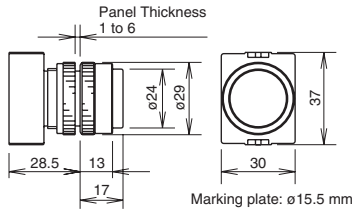

Round Flush Marking Type APW1B Transformer

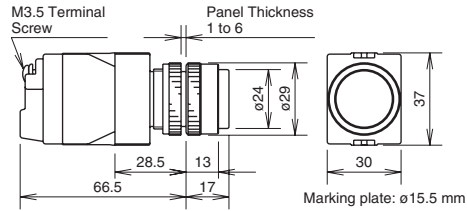

Dome APW2 Full Voltage

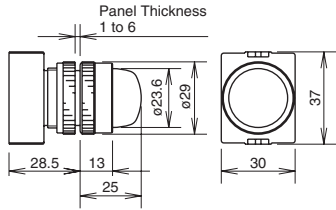

Dome APW2 Transformer

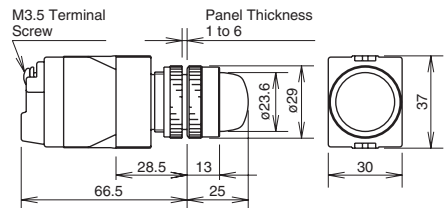

Square Flush Marking Type APQW1B Full Voltage

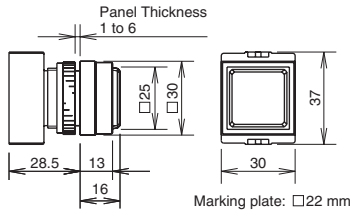

Square Flush Marking Type APQW1B Transformer

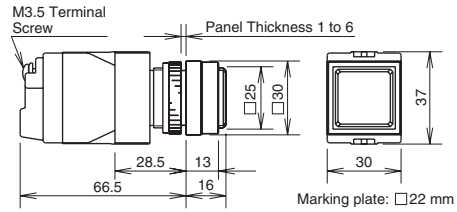

Illuminated Selector Switches

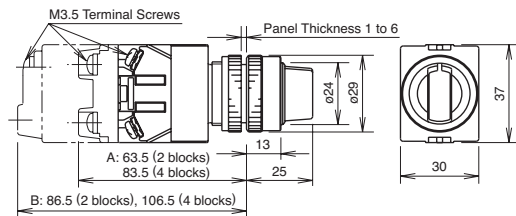

Switches & Pilot Lights

Display Lights

Relays & Sockets

Timers

Terminal Blocks

Circuit Breakers

Dimensions continued

Panel Cut-Out

Diagram	Part	Dimension			
		A	B	C	D
	Pushbuttons	Ø 0.137" (3.5mm)	1.95" (50mm); 1.76" (45mm) minimum	Ø 0.878" (22.3mm)	1.17" (30mm) Std. Octagonal > 1.56" (40mm) Large Mushroom
	Pilot Light				
	Illuminated Pushbuttons				
	Selector Switches				
	Illuminated Selector Switches				1.17" (30mm) *See note.

1. The Ø 0.137" (Ø 3.5mm) recess is necessary when either the nameplate or anti-rotation ring is used.
2. * >1.404" (36mm) for 2- or 3-position.
>1.95" (50mm) for 4- or 5-position.

Accessory Dimensions

OGL-31

Anti-Rotation Ring

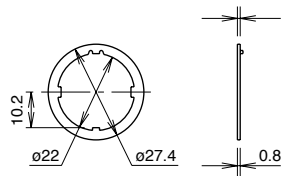

OLW-C

Metal Button Guard

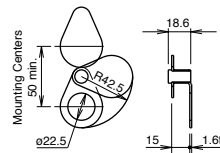

OCW-11

Pushbutton Rubber Boot

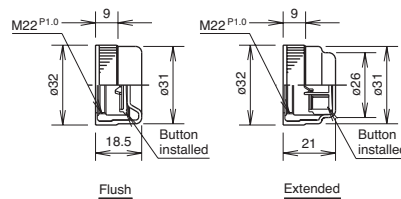

OB-31

Mounting Hole Rubber Plug

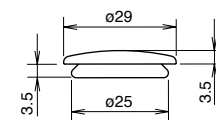

HW9Z-KL1

Lock-out Adaptor

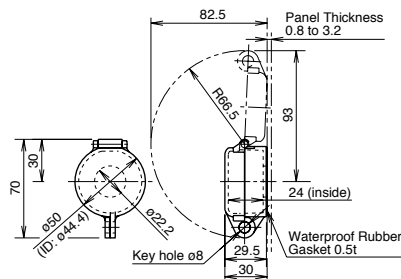

AW-RP1B

Round Plastic Bezel



AW-FP1B

Round Plastic w/Full Shroud



AW-QF1B

Square Full Shroud



Finger-Safe Cover Dimensions

HW-VL6

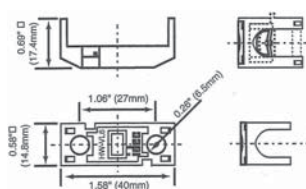

HW-VL5

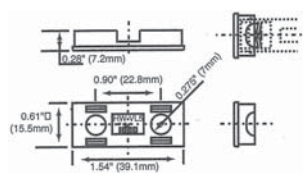

HW-VL4

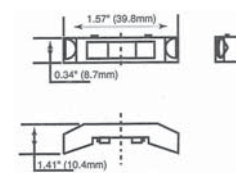

HW-VL3

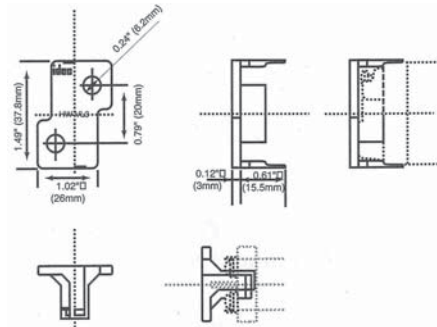

HW-VL2

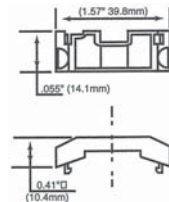

APS-PVL

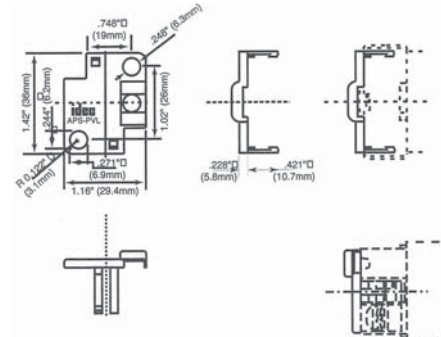

Switches & Pilot Lights

Display Lights

Relays & Sockets

Timers

Terminal Blocks

Circuit Breakers

Component Construction and General Instructions – TW Series

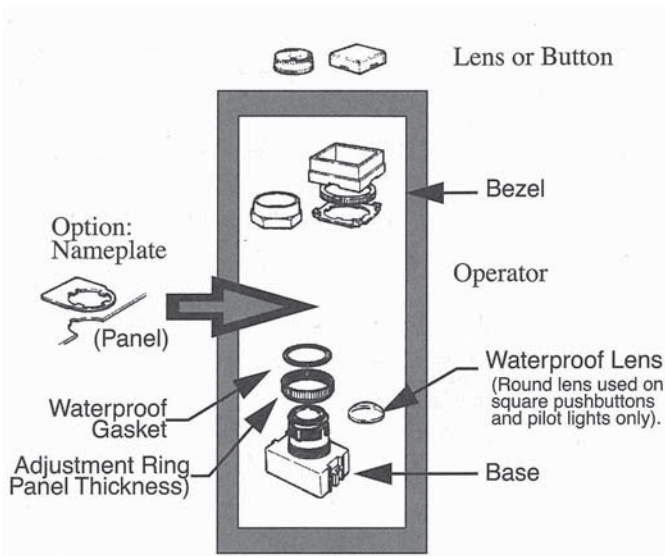

Instructions for Switches and Pilot Devices

TW Series: Adjustment for Panel Thickness

The panel thickness ring provides adjustment from 0.04" to 0.24" (1 to 6mm) in 0.004" (0.1mm) increments. Rotate the ring until the markings around the periphery are aligned for the desired thickness, as shown below.

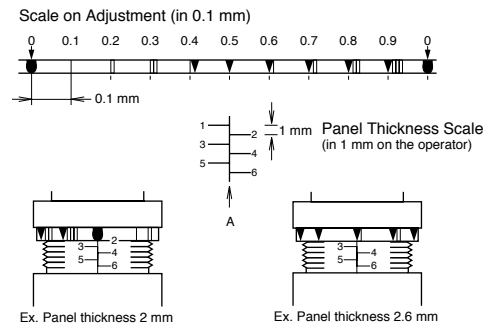

Note: When a nameplate or an anti-rotation ring is used, add 0.03" (0.8mm) to the panel thickness dimension.

An adjustment for panel thicknesses shown below can be made quickly by using the contact block remover.

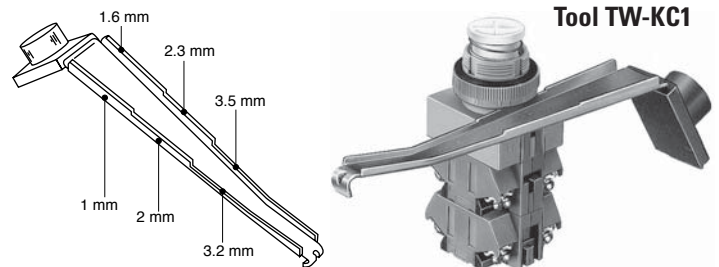

Tool TW-KC1

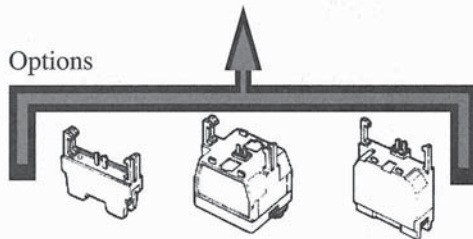
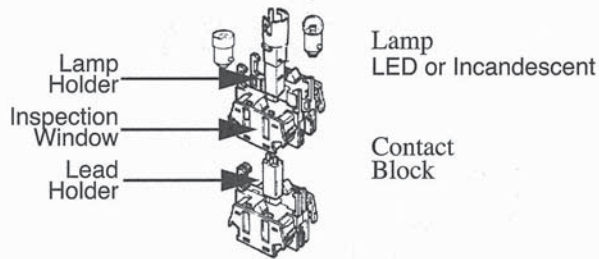

- Full Voltage Adaptor:**
Used with full voltage LED or incandescent.
- Full-Size Transformer:**
Used with incandescent/LED – even number of contact blocks.
- Half-Size Transformer:**
Used with incandescent – odd number of contact blocks.

Instructions continued

Pilot Lights and Pushbuttons

IMPORTANT: Install the body of the TW control unit with the panel thickness scale facing up.

Octagonal and Round Bezels

Octagonal and round bezels screw into the operator. Use a locking ring wrench (optional) for secure tightening and easy removal. Round flush and extended buttons snap onto the operator base. Mushroom buttons screw onto the operator base.

Every round lens can be used with or without legend markings. Engraving can be done on a white translucent plate which is placed in the lens, or clear mylar can be printed and placed in the lens.

Round Marking Unit

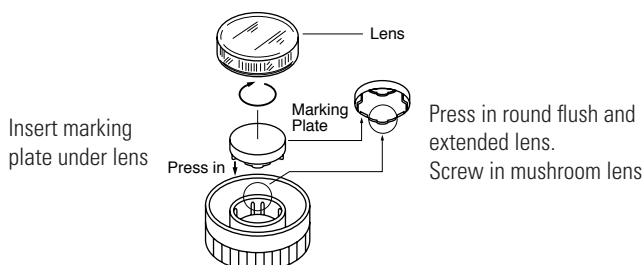

Square Bezels

Square bezels are installed in a 3-step procedure. First install the base plate from the front. Then install the lock nut using the nut locking wrench (optional). Finally, install the square bezel, which snap-fits onto the base plate. Square buttons also snap onto the operator base.

Every square lens can be used with or without legend markings. Engraving can be done on a white translucent plate which is placed in the lens, or clear mylar can be printed and placed in the lens. Square units include a round waterproof lens which screws into the operator. The square outer lens snaps on.

Square Marking Units

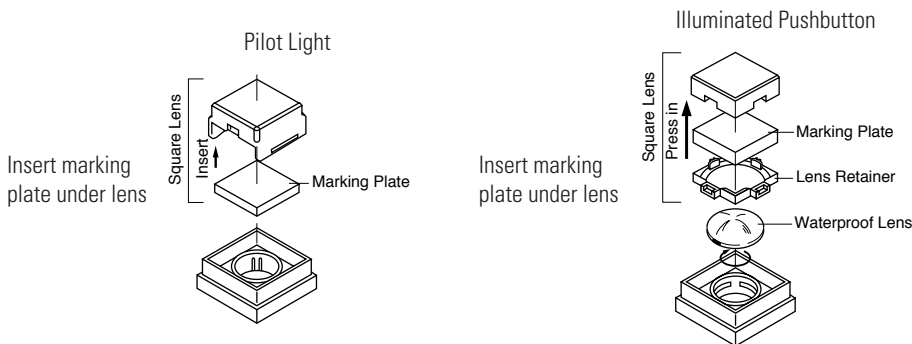

To remove square lens from operator, place a screwdriver under the indentation on the side of the lens. To remove the marking plate, place a screwdriver under the indentation and lift out the plate. The lens retainer can be removed by pressing a 3/16" screwdriver into one of the recesses.

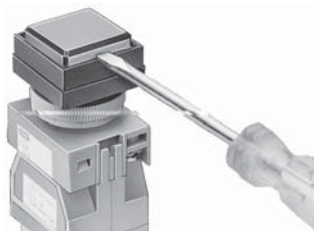

Marking Plate Engraving Area

Shape	Engraving Area	Used With	Part Number
Round	Ø 0.55" (14mm)	Illuminated pushbuttons	ALW2B
	Ø 0.55" (14mm)	Pilot lights	APW2B
Mushroom	Ø 0.55" (14mm)	Illuminated mushroom	ALW3B
Square	□ 0.83" (21mm)	Square pilot lights	APQW1B
Square	□ 0.83" (21mm)	Square illuminated pushbuttons	ALQW2B

Switches & Pilot Lights

Display Lights

Relays & Sockets

Timers

Terminal Blocks

Circuit Breakers

Instructions continued

Selector Switches

The operator shaft of each unit has a recess to identify in which direction to install the handle. Align the handle with the recess. Press color insert (TW-HC1) into the handle and then press handle into the operator, as shown below.

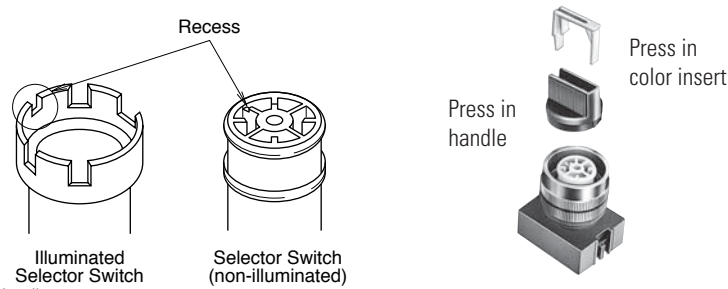

Remove color insert before pulling out the handle.

Standard Operating Positions



Positions: Non-Illuminated 3-Position Operators

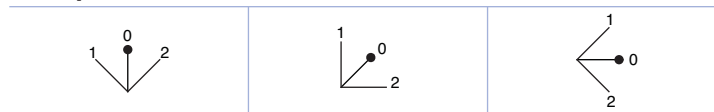

Installation

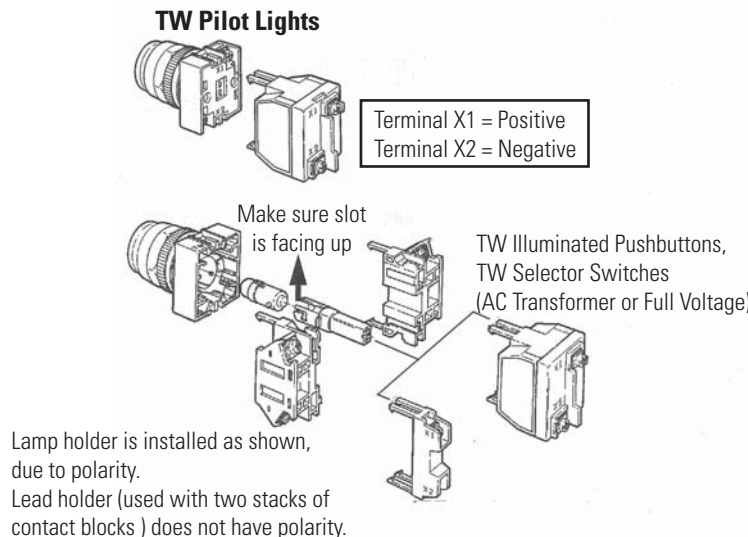

Installation of LED Illuminated Units

AC transformers are recommended for use in areas subjected to inductive noise. When using full voltage types, install a protection diode as shown below. (Diode with DC power supply to protect against surges and noise.)

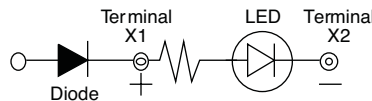

Make sure that LED illuminated units are installed with correct polarity, as indicated at the terminals.