

## Interference Suppression Film Capacitors MKT Radial Potted Type

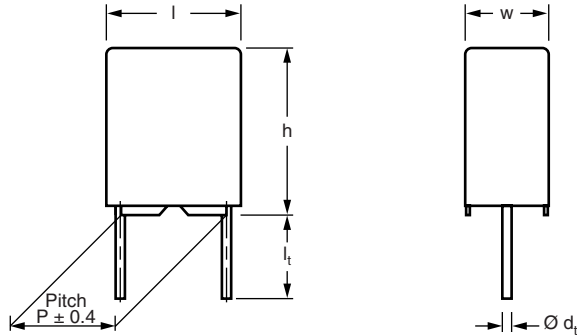

Dimensions in mm

### APPLICATIONS

High stability grade for continuous across the line X2 applications.

See also "Application Note":

[www.vishay.com/doc?28153](http://www.vishay.com/doc?28153)

### REFERENCE STANDARDS

IEC 60384-14 ed-3 and EN 60384-14

"IEC 60065 pass. flamm. class C"

UL 1283

UL 1414

CSA-E384-14

### MARKING

C-value; tolerance; rated voltage; sub-class; manufacturer's type; code for dielectric material; manufacturer location; manufacturer's logo; year and week; safety approvals

### DIELECTRIC

Polyester film

### ELECTRODES

Metallized

### CONSTRUCTION

Series construction

### RATED VOLTAGE

AC 310 V; 50 Hz to 60 Hz

### FEATURES

15 to 37.5 mm lead pitch.

Supplied loose in box, taped on reel

RoHS compliant

Compliant to RoHS directive 2002/95/EC

### PERMISSIBLE DC VOLTAGE

DC 630 V

### ENCAPSULATION

Plastic case, epoxy resin sealed, flame retardant UL-class 94 V-0

### CLIMATIC TESTING CLASS ACC. TO IEC 60068-1

40/110/56/C

### CAPACITANCE RANGE (E12 SERIES)

E12 series 0.01 to 2.2  $\mu$ F

Preferred values acc. to E6

### CAPACITANCE TOLERANCE

$\pm 10\%$ ,  $\pm 20\%$  ( $\pm 5\%$  on request)

### LEADS

Tinned wire

### MAXIMUM APPLICATION TEMPERATURE

110 °C

### DETAIL SPECIFICATION

For more detailed data and test requirements contact:

[RFI@vishay.com](mailto:RFI@vishay.com)



**RoHS**  
COMPLIANT

## COMPOSITION OF CATALOG NUMBER

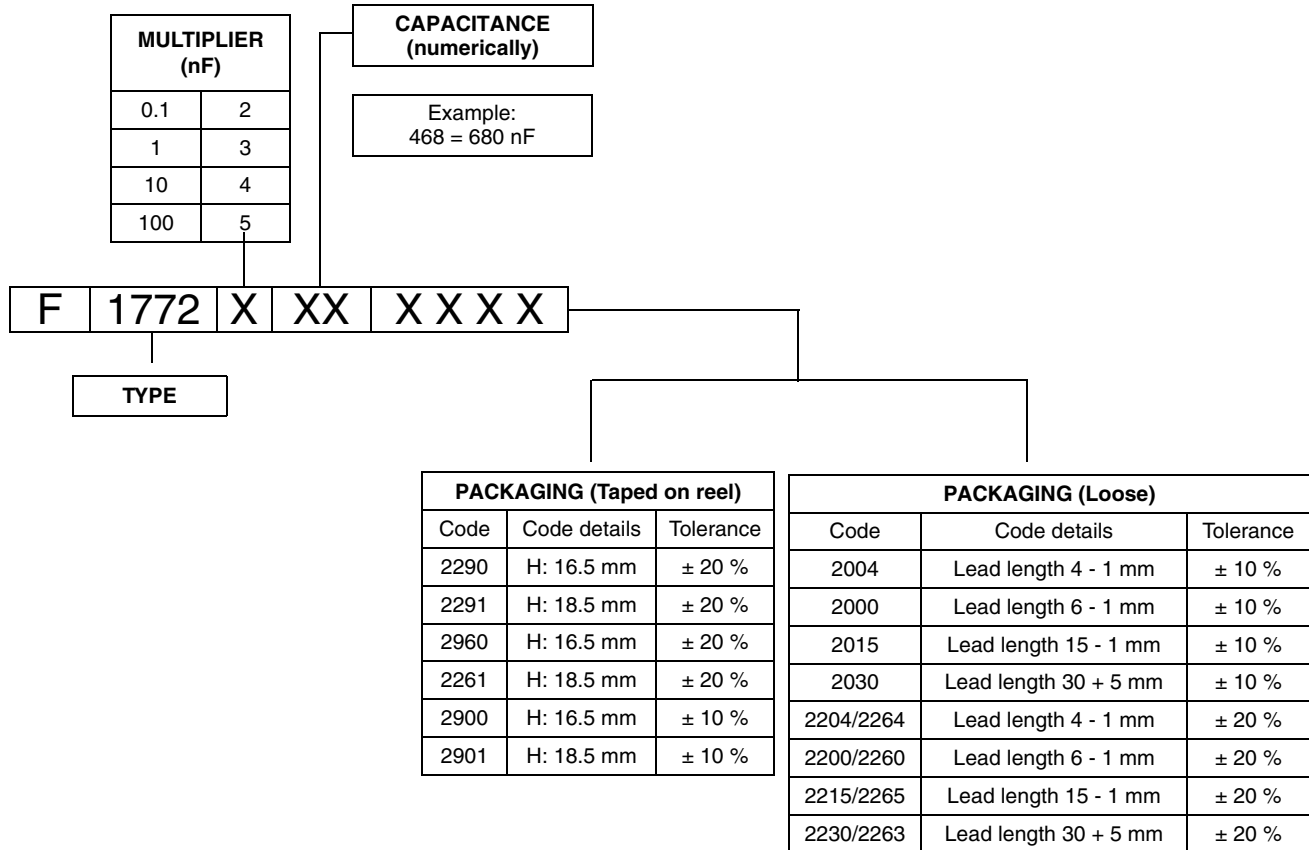

### Note

(1) For detailed tape specifications refer to "Packaging Information" [www.vishay.com/doc?28139](http://www.vishay.com/doc?28139)

## SPECIFIC REFERENCE DATA

DESCRIPTION	VALUE
Rated AC voltage ( $U_{Rac}$ )	310 V
Permissible DC voltage ( $U_{Rdc}$ )	630 V
Tangent of loss angle	$\leq 100 \times 10^{-4}$ at 1 kHz
Rated voltage pulse slope at $(dU/dt)_R$ 435 Vdc	100 V/ $\mu$ s
R between leads, for $C \leq 0.33 \mu$ F at 100 V; 1 min	$> 15\ 000\ M\Omega$
RC between leads, $C > 0.33 \mu$ F at 100 V; 1 min	$> 5000\ s$
R between leads and case; 100 V; 1 min	$> 30\ 000\ M\Omega$
Withstanding (DC) voltage (cut off current 10 mA); rise time 100 V/s	
$C \leq 1 \mu$ F	2200 V; for 1 min
$C > 1 \mu$ F	1800 V; for 1 min
Withstanding (AC) voltage between leads and case	2120 V; 1 min
Maximum application temperature	110 °C

Interference Suppression Film Capacitors  
MKT Radial Potted Type

Vishay BCcomponents

C-tol. = ± 10 %

CAPACITANCE (µF)	PITCH (mm)	DIMENSIONS w x h x l MAX. (mm)	MASS (g)	SPQ (pieces) SHORT LEAD	ORDERING CODE (1)(2)
<b>d<sub>t</sub> = 0.60 mm ± 0.06 mm</b>					
0.01	15	5.0 x 11.0 x 17.5	1.4	750	F 1772-310-20..
0.012	15	5.0 x 11.0 x 17.5	1.4	750	F 1772-312-20..
0.015	15	5.0 x 11.0 x 17.5	1.4	750	F 1772-315-20..
0.018	15	5.0 x 11.0 x 17.5	1.4	750	F 1772-318-20..
0.022	15	5.0 x 11.0 x 17.5	1.4	750	F 1772-322-20..
0.027	15	5.0 x 11.0 x 17.5	1.4	750	F 1772-327-20..
0.033	15	5.0 x 11.0 x 17.5	1.4	750	F 1772-333-20..
0.039	15	6.0 x 12.0 x 17.5	2.0	500	F 1772-339-20..
0.047	15	6.0 x 12.0 x 17.5	2.0	500	F 1772-347-20..
0.056	15	6.0 x 12.0 x 17.5	2.0	500	F 1772-356-20..
<b>d<sub>t</sub> = 0.80 mm ± 0.08 mm</b>					
0.068	15	7.0 x 13.5 x 17.5	2.4	450	F 1772-368-20..
0.082	15	8.5 x 15.0 x 17.5	2.7	300	F 1772-382-20..
0.10	15	8.5 x 15.0 x 17.5	2.7	325	F 1772-410-2000
0.10	15	8.5 x 15.0 x 17.5	2.7	300	F 1772-410-2004
0.12	15	8.5 x 15.0 x 17.5	2.7	300	F 1772-412-20..
0.15	22.5	7.0 x 16.5 x 26.0	4.1	235	F 1772-415-20..
0.18	22.5	7.0 x 16.5 x 26.0	4.1	235	F 1772-418-20..
0.22	22.5	8.5 x 18.0 x 26.0	4.6	200	F 1772-422-20..
0.27	22.5	10.0 x 19.5 x 26.0	6.7	170	F 1772-427-20..
0.33	22.5	10.0 x 19.5 x 26.0	6.7	170	F 1772-433-20..
0.39	27.5	11.0 x 21.0 x 31.0	9.1	125	F 1772-439-20..
0.47	27.5	11.0 x 21.0 x 31.0	9.1	125	F 1772-447-20..
0.56	27.5	11.0 x 21.0 x 31.0	9.1	125	F 1772-456-20..
0.68	27.5	13.0 x 23.0 x 31.0	12.9	110	F 1772-468-20..
0.82	27.5	13.0 x 23.0 x 31.0	12.9	110	F 1772-482-20..
1.0	27.5	15.0 x 25.0 x 31.5	15.0	100	F 1772-510-20..
1.2	37.5	14.5 x 24.5 x 41.5	18.9	80	F 1772-512-20..
1.5	37.5	15.5 x 28.5 x 41.5	24.0	70	F 1772-515-20..
1.8	37.5	15.5 x 28.5 x 41.5	24.0	70	F 1772-518-20..
2.2	37.5	18.0 x 32.5 x 41.5	31.6	60	F 1772-522-20..

**Notes**

(1) These capacitors can be delivered on continuous tape and reel.

The ordering code is:

F 1772-...-2900 at H = 16.5 mm

F 1772-...-2901 at H = 18.5 mm

(2) Further information about packing quantities with different lead length and/or taped versions, see document "Packing Quantities"

[www.vishay.com/doc?26535](http://www.vishay.com/doc?26535)

• SPQ = Standard Packing Quantity

• For detailed tape specifications refer to "Packaging Information" [www.vishay.com/doc?28139](http://www.vishay.com/doc?28139) or end of catalog

# F 1772-2 310 V-X2



## Vishay BCcomponents Interference Suppression Film Capacitors MKT Radial Potted Type

C-tol. = ± 20 %

CAPACITANCE ( $\mu$ F)	PITCH (mm)	DIMENSIONS w x h x l MAX. (mm)	MASS (g)	SPQ (pieces) SHORT LEAD	ORDERING CODE <sup>(1)(2)</sup>
<b><math>d_t = 0.60 \text{ mm} \pm 0.06 \text{ mm}</math></b>					
0.01	15	5.0 x 11.0 x 17.5	1.4	750	F 1772-310-22..
0.015	15	5.0 x 11.0 x 17.5	1.4	750	F 1772-315-22..
0.022	15	5.0 x 11.0 x 17.5	1.4	750	F 1772-322-22..
0.033	15	5.0 x 11.0 x 17.5	1.4	750	F 1772-333-22..
0.047	15	5.0 x 11.0 x 17.5	1.4	750	F 1772-347-22..
0.068	15	6.0 x 12.0 x 17.5	2.0	600	F 1772-368-22..
0.10	15	6.0 x 12.0 x 17.5	2.0	600	F 1772-410-22..
<b><math>d_t = 0.80 \text{ mm} \pm 0.08 \text{ mm}</math></b>					
0.15	15	8.5 x 15.0 x 17.5	2.7	325	F 1772-415-226..
0.15	22.5	6.0 x 15.5 x 26.0	3.3	260	F 1772-415-22...
0.22	15	10.0 x 16.5 x 17.5	4.5	300	F 1772-422-226..
0.22	22.5	7.0 x 16.5 x 26.0	4.1	235	F 1772-422-22...
0.33	15	13.5 x 22.5 x 18.0	5.5	185	F 1772-433-226..
0.33	22.5	8.5 x 18.0 x 26.0	5.3	190	F 1772-433-22..
0.47	22.5	10.0 x 19.5 x 26.0	6.7	170	F 1772-447-226..
0.47	27.5	9.0 x 19.0 x 31.5	6.8	160	F 1772-447-22..
0.68	22.5	12.0 x 22.0 x 26.0	13.4	110	F 1772-468-226..
0.68	27.5	11.0 x 21.0 x 31.0	12.9	125	F 1772-468-22..
1.0	22.5	15.5 x 26.5 x 26.5	13.5	110	F 1772-510-226..
1.0	27.5	15.0 x 25.0 x 31.5	15.0	100	F 1772-510-22..
1.5	27.5	18.0 x 28.0 x 31.5	19.0	85	F 1772-515-226..
1.5	37.5	14.5 x 24.5 x 41.5	18.9	80	F 1772-515-22..
2.2	27.5	21.0 x 31.0 x 31.0	28.0	70	F 1772-522-226..
2.2	37.5	15.5 x 28.5 x 41.5	24.0	70	F 1772-522-22..

### Notes

(1) These capacitors can be delivered on continuous tape and reel

The ordering code is:

F 1772-...-2290 at H = 16.5 mm

F 1772-...-2291 at H = 18.5 mm

F 1772-...-2960 at H = 16.5 mm

F 1772-...-2961 at H = 18.5 mm

(2) Further information about packing quantities with different lead length and/or taped versions, see document "Packing Quantities"

[www.vishay.com/docs?26535](http://www.vishay.com/docs?26535)

- SPQ = Standard Packing Quantity

- For detailed tape specifications refer to Packaging Information: [www.vishay.com/doc?28139](http://www.vishay.com/doc?28139)

### APPROVALS

SAFETY APPROVALS X2	VOLTAGE	VALUE	FILE NUMBERS
EN 60384-14 (ENEC) (= IEC 60384-14 ed 3)	310 Vac	0.01 - 2.2 $\mu$ F X2	40005079
UL 1414	250 Vac	0.01 - 1.0 $\mu$ F X2	E 100682
UL 1283	250 Vac	0.01 - 2.2 $\mu$ F X2	E 76297
CSA-E 384-14	310 Vac	0.01 - 2.2 $\mu$ F X2	2127723
CB TEST-CERTIFICATE	310 Vac	0.01 - 2.2 $\mu$ F X2	DE 1-40110/A1

The ENEC-approval together with the CB-Certificate replace all national marks of the following countries (they have already signed the ENEC-Agreement): Austria; Belgium; Czech. Republic; Denmark; Finland; France; Germany; Greece; Hungary; Ireland; Italy; Luxembourg; Netherlands; Norway; Portugal; Slovenian; Spain; Sweden; Switzerland and United Kingdom.



## MOUNTING

### Normal Use

The capacitors are designed for mounting on printed-circuit boards. The capacitors packed in bandoliers are designed for mounting in printed-circuit boards by means of automatic insertion machines.

For detailed tape specifications refer to "Packaging Information".

### Specific Method of Mounting to Withstand Vibration and Shock

In order to withstand vibration and shock tests, it must be ensured that stand-off pips are in good contact with the printed-circuit board:

- For pitches  $\leq 15$  mm capacitors shall be mechanically fixed by the leads
- For larger pitches the capacitors shall be mounted in the same way and the body clamped

### Space Requirements On Printed-Circuit Board

The maximum length and width of film capacitors is shown in the drawing:

- Eccentricity as in drawing. The maximum eccentricity is smaller than or equal to the lead diameter of the product concerned.
- Product height with seating plane as given by "IEC 60717" as reference:  $h_{\max.} \leq h + 0.3$  mm or  $h'_{\max.} \leq h' + 0.3$  mm

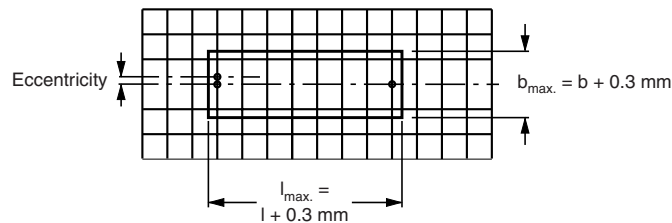

### Storage Temperature

- Storage temperature:  $T_{\text{stg}} = -25$  °C to  $+40$  °C with RH maximum 80 % without condensation

### Ratings and Characteristics Reference Conditions

Unless otherwise specified, all electrical values apply to an ambient temperature of  $23$  °C  $\pm 1$  °C, an atmospheric pressure of 86 kPa to 106 kPa and a relative humidity of  $50$  %  $\pm 2$  %.

For reference testing, a conditioning period shall be applied over  $96$  h  $\pm 4$  h by heating the products in a circulating air oven at the rated temperature and a relative humidity not exceeding 20 %.

### CHARACTERISTICS

Capacitance as a function of ambient temperature (typical curve)

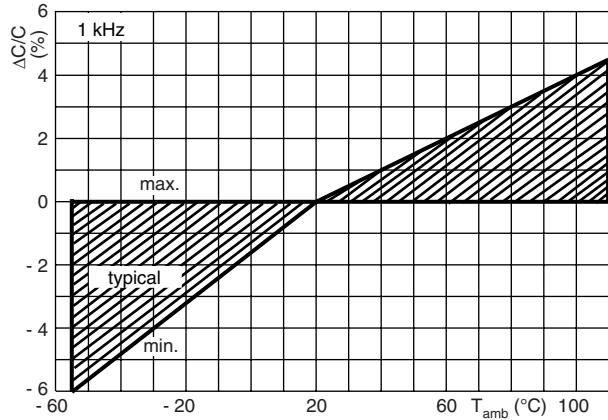

Impedance as a function of frequency (typical curve)

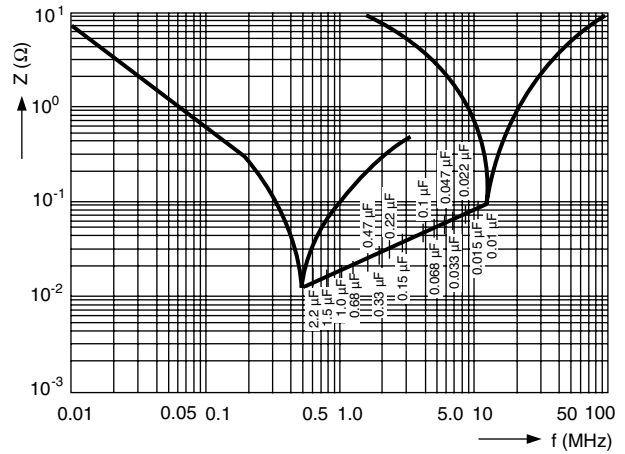

Tangent of loss angle as a function of frequency (typical curve)

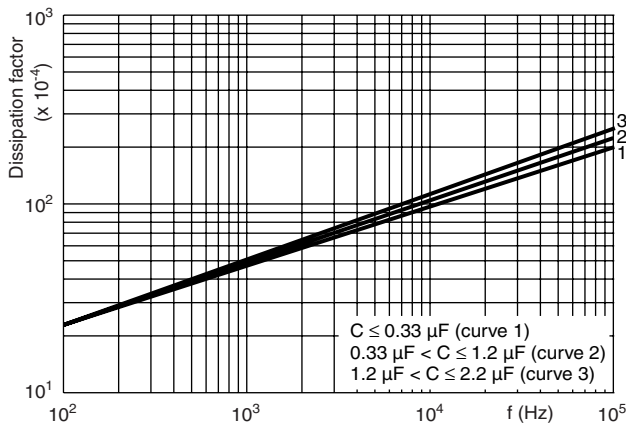

Resonant frequency as a function of capacitance (typical curve)

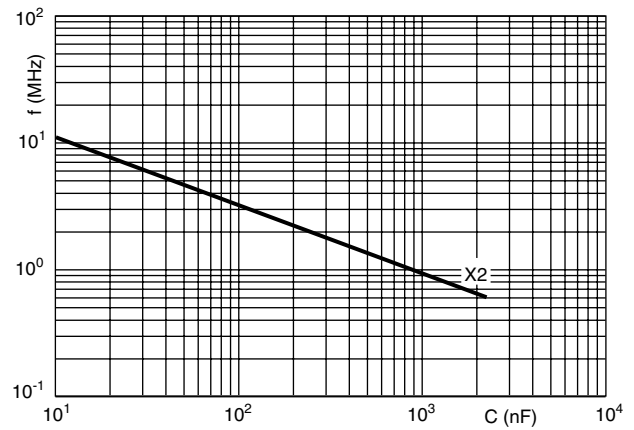

Max. RMS voltage as a function of frequency

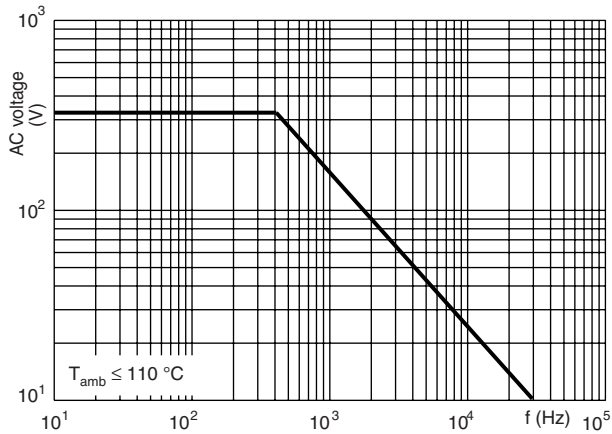

Max. RMS current as a function of frequency

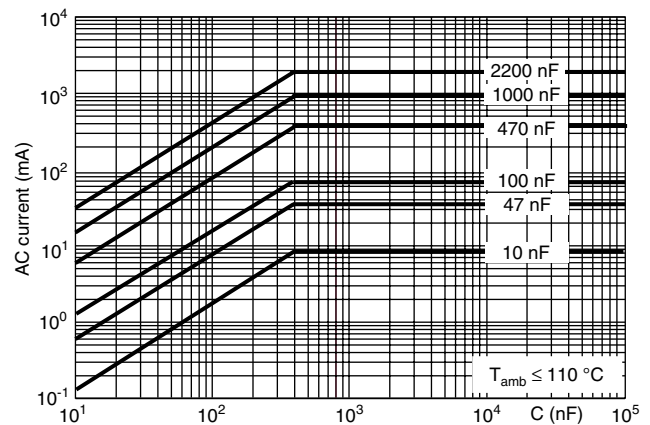

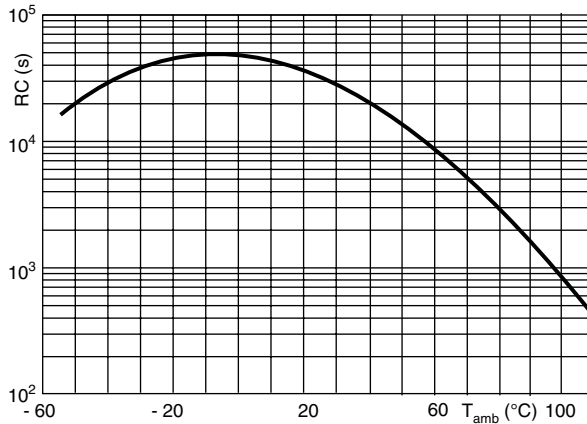
Insulation resistance as a function of ambient temperature  
 (typical curve)

### APPLICATION NOTES AND LIMITING CONDITIONS

- For X2 electromagnetic interference suppression where a higher stability grade is needed for **continuous across the line applications** (50 Hz/60 Hz) with a maximum mains voltage of 310 Vac.
- These capacitors are not intended for continuous pulse application. For these situations capacitors of the AC and pulse programs must be used.
- For series impedance applications we refer to application note: [www.vishay.com/doc?28153](http://www.vishay.com/doc?28153)
- The maximum ambient temperature must not exceed 110 °C.
- Rated voltage pulse slope:  
If the pulse voltage is lower than the rated voltage, the values of the specific reference data can be multiplied by 435 Vdc and divided by the applied voltage.

### INSPECTION REQUIREMENTS

#### General Notes:

Sub-clause numbers of tests and performance requirements refer to the “Sectional Specification, Publication IEC 60384-14 ed 3 and Specific Reference Data”.

#### Group C Inspection Requirements

SUB-CLAUSE NUMBER AND TEST	CONDITIONS	PERFORMANCE REQUIREMENTS
<b>SUB-GROUP C1A PART OF SAMPLE OF SUB-GROUP C1</b>		
4.1 Dimensions (detail)  Initial measurements	Capacitance Tangent of loss angle: For C ≤ 1 μF at 10 kHz For C > 1 μF at 1 kHz	As specified in chapter “General Data” of this specification
4.3 Robustness of terminations	Tensile: Load 10 N; 10 s Bending: Load 5 N; 4 x 90°	No visible damage
4.4 Resistance to soldering heat	No pre-drying Method: 1A Solder bath: 280 °C ± 5 °C Duration: 10 s	

Vishay BCcomponents Interference Suppression Film Capacitors  
MKT Radial Potted Type

SUB-CLAUSE NUMBER AND TEST	CONDITIONS	PERFORMANCE REQUIREMENTS
<b>SUB-GROUP C1A PART OF SAMPLE OF SUB-GROUP C1</b>		
4.19 Component solvent resistance  4.4.2 Final measurements	Isopropylalcohol at room temperature Method: 2 Immersion time: 5 ± 0.5 min Recovery time: Min. 1 h, max. 2 h  Visual examination  Capacitance  Tangent of loss angle  Insulation resistance	No visible damage Legible marking  $ \Delta C/C  \leq 5\%$ of the value measured initially  Increase of $\tan \delta$ $\leq 0.008$ for: $C \leq 1 \mu F$ or $\leq 0.005$ for: $C > 1 \mu F$ Compared to values measured initially As specified in section "Insulation Resistance" of this specification
<b>SUB-GROUP C1B PART OF SAMPLE OF SUB-GROUP C1</b>		
Initial measurements  4.20 Solvent resistance of the marking  4.6 Rapid change of temperature  4.6.1 Inspection  4.7 Vibration  4.7.2 Final inspection  4.9 Shock  4.9.2 Final measurements	Capacitance Tangent of loss angle: For $C \leq 1 \mu F$ at 10 kHz For $C > 1 \mu F$ at 1 kHz  Isopropylalcohol at room temperature Method: 1 Rubbing material: Cotton wool Immersion time: 5 ± 0.5 min  $\theta A = -40^\circ C$ $\theta B = +110^\circ C$ 5 cycles Duration $t = 30$ min  Visual examination  Mounting: See section "Mounting" of this specification Procedure B4 Frequency range: 10 Hz to 55 Hz Amplitude: 0.75 mm or Acceleration 98 m/s <sup>2</sup> (whichever is less severe) Total duration 6 h  Visual examination  Mounting: See section "Mounting" for more information Pulse shape: Half sine Acceleration: 490 m/s <sup>2</sup> Duration of pulse: 11 ms  Visual examination  Capacitance  Tangent of loss angle  Insulation resistance	No visible damage Legible marking      No visible damage        No visible damage        No visible damage  $ \Delta C/C  \leq 5\%$ of the value measured initially  Increase of $\tan \delta$ $\leq 0.008$ for: $C \leq 1 \mu F$ or $\leq 0.005$ for: $C > 1 \mu F$ Compared to values measured initially As specified in section "Specific Reference" of this specification





Interference Suppression Film Capacitors Vishay BCcomponents  
MKT Radial Potted Type

SUB-CLAUSE NUMBER AND TEST	CONDITIONS	PERFORMANCE REQUIREMENTS
<b>SUB-GROUP C1 COMBINED SAMPLE OF SPECIMENS OF SUB-GROUPS C1A AND C1B</b>		
4.11 Climatic sequence 4.11.1 Initial measurements 4.11.2 Dry heat 4.11.3 Damp heat cyclic Test Db, first cycle 4.11.4 Cold 4.11.5 Damp heat cyclic Test Db, remaining cycles 4.11.6 Final measurements	Capacitance Measured in 4.4.2 and 4.9.2 Tangent of loss angle Measured initially in C1A and C1B Temperature: 110 °C Duration: 16 h Temperature: - 40 °C Duration: 2 h Visual examination Capacitance Tangent of loss angle Voltage proof 1350 Vdc 1 min between terminations Insulation resistance	No visible damage Legible marking $ \Delta C/C  \leq 5\%$ of the value measured in 4.11.1 Increase of $\tan \delta$ $\leq 0.008$ for: $C \leq 1 \mu\text{F}$ or $\leq 0.005$ for: $C > 1 \mu\text{F}$ Compared to values measured in 4.11.1 No permanent breakdown or flash-over $\geq 50\%$ of values specified in section "Insulation Resistance" of this specification
<b>SUB-GROUP C2</b>		
4.12 Damp heat steady state 4.12.1 Initial measurements 4.12.3 Final measurements	56 days, 40 °C, 90 % to 95 % RH No load Capacitance Tangent of loss angle: 1 kHz Visual examination Capacitance Tangent of loss angle Voltage proof 1350 Vdc; 1 min between terminations Insulation resistance	No visible damage Legible marking $ \Delta C/C  \leq 5\%$ of the value measured in 4.12.1 Increase of $\tan \delta$ $\leq 0.008$ for: $C \leq 1 \mu\text{F}$ or $\leq 0.005$ for: $C > 1 \mu\text{F}$ Compared to values measured in 4.12.1 No permanent breakdown or flash-over $\geq 50\%$ of values specified in section "Insulation Resistance" of this specification
<b>SUB-GROUP C3</b>		
4.13.1 Initial measurements 4.13 Impulse voltage	Capacitance Tangent of loss angle: For $C \leq 1 \mu\text{F}$ at 10 kHz For $C > 1 \mu\text{F}$ at 1 kHz 3 successive impulses, full wave, peak voltage: X2: 2.5 kV for $C \leq 1 \mu\text{F}$ X2: 2.5 kV/ $\sqrt{C}$ for $C > 1 \mu\text{F}$ Max. 24 pulses	No self healing breakdowns or flash-over

Vishay BCcomponents Interference Suppression Film Capacitors  
MKT Radial Potted Type

SUB-CLAUSE NUMBER AND TEST	CONDITIONS	PERFORMANCE REQUIREMENTS
<b>SUB-GROUP C3</b>		
4.14 Endurance	Duration: 1000 h 1.25 x U <sub>Rac</sub> at 110 °C Once in every hour the voltage is increased to 1000 V (RMS) for 0.1 s via resistor of 47 Ω ± 5 %	
4.14.7 Final measurements	Visual examination  Capacitance  Tangent of loss angle  Voltage proof 1350 Vdc; 1 min between terminations 2120 Vac; 1 min between terminations and case  Insulation resistance	No visible damage Legible marking   ΔC/C  ≤ 5 % compared to values measured in 4.13.1  Increase of tan δ ≤ 0.008 for: C ≤ 1 μF or ≤ 0.005 for: C > 1 μF Compared to values measured in 4.13.1  No permanent breakdown or flash-over  ≥ 50 % of values specified in section "Insulation Resistance" of this specification
<b>SUB-GROUP C4</b>		
4.15 Charge and discharge	10 000 cycles Charged to 435 Vdc Discharge resistance: $R = \frac{435 \text{ Vdc}}{1.5 \times C(dU/dt)}$	
4.15.1 Initial measurements	Capacitance Tangent of loss angle: For C ≤ 1 μF at 10 kHz For C > 1 μF at 1 kHz	
4.13.3 Final measurements	Capacitance  Tangent of loss angle  Insulation resistance	ΔC/C  ≤ 10 % compared to values measured in 4.15.1  Increase of tan δ ≤ 0.008 for: C ≤ 1 μF or ≤ 0.005 for: C > 1 μF Compared to values measured in 4.15.1  ≥ 50 % of values specified in section "Insulation Resistance" of this specification
<b>SUB-GROUP C5</b>		
4.16 Radio frequency characteristic	Resonance frequency	≥ 0.9 times the value as specified in section "Resonant Frequency" of this specification.

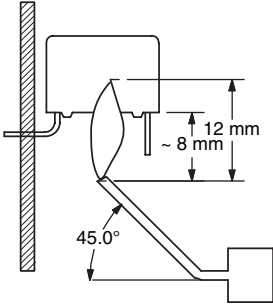
SUB-CLAUSE NUMBER AND TEST	CONDITIONS	PERFORMANCE REQUIREMENTS
<b>SUB-GROUP C6</b>		
4.17 Passive flammability Class C	Bore of gas jet: $\varnothing$ 0.5 mm Fuel: Butane Test duration for actual volume V in mm <sup>3</sup> : V $\leq$ 250: 5 s 250 < V $\leq$ 500: 10 s 500 < V $\leq$ 1750: 20 s V > 1750: 30 s One flame application 	After removing test flame from capacitor, the capacitor must not continue to burn for more than 30 s. No burning particle must drop from the sample
<b>SUB-GROUP C7</b>		
4.18 Active flammability	20 cycles of 2.5 kV discharges on the test capacitor connected to U <sub>Rac</sub>	The cheese cloth around the capacitors shall not burn with a flame No electrical measurements are required