

32/35 SERIES

- PRESSFIT INDICATOR LIGHTS
- NEON, LED & INCANDESCENT
- 2 TO 600 DESIGN VOLTS
- 6" WIRE LEADS & 3/16" TAB TERMINALS
- VARIETY OF LENS COLORS
- UL AND CSA LISTED • UL FILE E20356
- CSA FILE LR15284-5

Overview

The 32/35 Series Indicators feature a wide variety of lenses, colors, voltage & bezel variations. Indicators quickly pressfit into a 0.500" to 0.510" mounting hole with recommended panel thickness range of 0.020" min. to 0.090" max. A speednut, part number **8700071674**, and Adapters for 0.514" to 0.519" are available.

Specifications

Housing: white nylon. A black housing is available.

Bezel: nickel plated brass. A black anodized bezel is available.

Lens: polycarbonate.

Incandescent AC or DC voltage options: 6, 14 and 28 volts.

Neon AC or DC voltage options: 125, 250 and 600 volts. **Note:** high brightness green and blue neon lamps supplied in green and blue neon applications.

LED DC voltage options: 2, 6, 12, 24 volts.

LED AC voltage options: 125 volts.

Note: 125 volts AC units contain a bi-polar LED.

Two 6" wire leads: #20 AWG, black, bare copper, PVC insulated, UL/CSA rated 105°C, 600 V, UL style 1015, stripped 1/2". For DC LED units, wire leads are color-coded red and black; the red wire lead denotes the anode (+) while a black wire lead identifies the cathode (-). For AC LED units, wire leads are white. Custom wire lengths, stripping, termination and wire types are available.

Terminals:

3/16" tabs: brass, (0.187" length x 0.020" thick). For LED units, a tin plated terminal denotes the anode (+). 1/4" or 1/8" brass tab terminals are available.

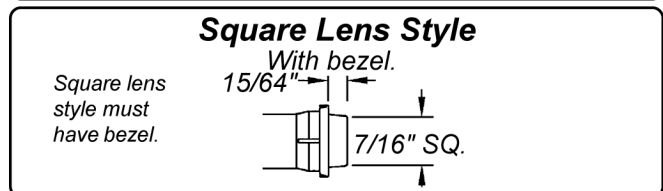
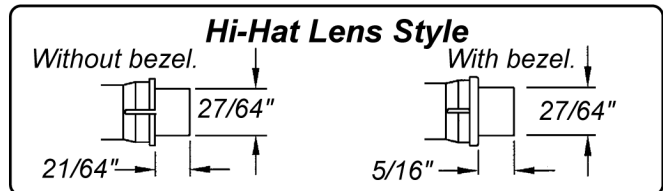
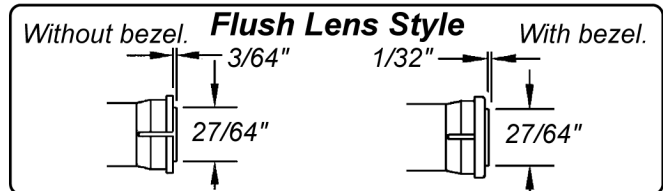
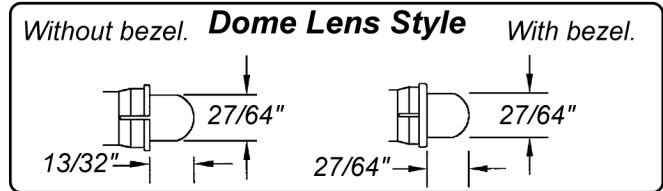
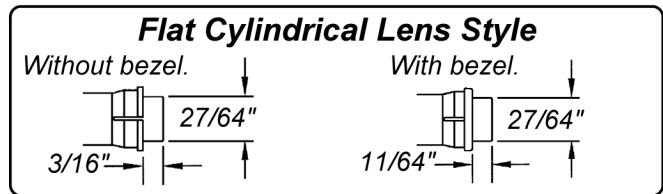
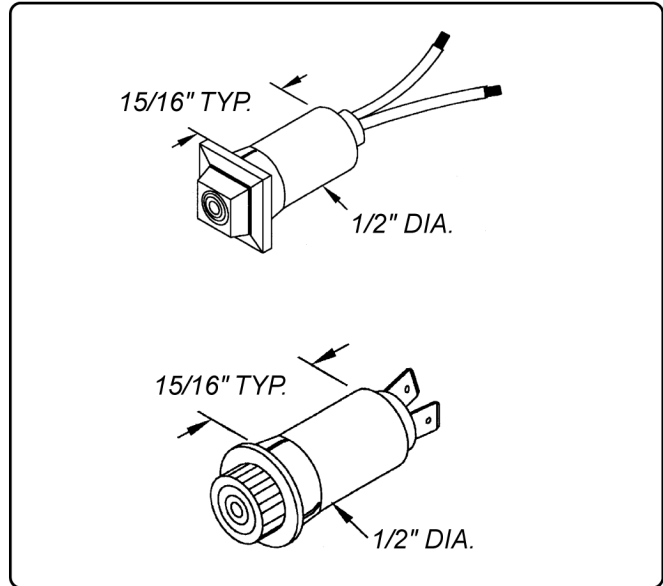

**32/35 Series
Flush Lens
Nickel Plated Bezel
Neon or
Incandescent**

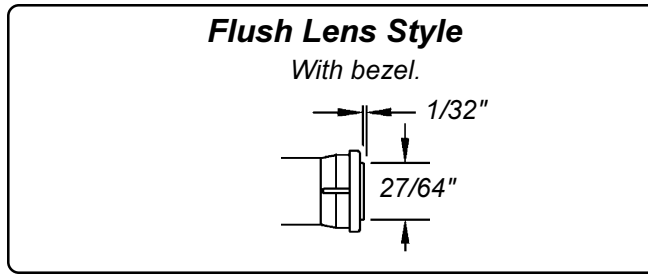

**6" Wire Leads or
3/16" Tab Terminals
White Housing
6 to 250 Design Volts
PressFit Mounting**

Part Number 6" Wire Leads	Part Number 3/16" Tab Terminals	Lens Color	Lamp Type	Design Volts	Design Watts or Amps	Life (hrs)
32R-2311	32R-2311T	Red	Neon	125	1/3W	25,000
35R-2311	35R-2311T	Red	Neon	250	1/3W	25,000
32RG1-2311	32RG1-2311T	Red	Incandescent	6	.20A	5,000
32RG3-2311	32RG3-2311T	Red	Incandescent	14	.10A	10,000
32RG18-2311	32RG18-2311T	Red	Incandescent	28	.04A	7,000
32R-2312	32R-2312T	Green	Neon	125	1/3W	25,000
35R-2312	35R-2312T	Green	Neon	250	1/3W	25,000
32RG1-2312	32RG1-2312T	Green	Incandescent	6	.20A	5,000
32RG3-2312	32RG3-2312T	Green	Incandescent	14	.10A	10,000
32RG18-2312	32RG18-2312T	Green	Incandescent	28	.04A	7,000
32R-2313	32R-2313T	Amber	Neon	125	1/3W	25,000
35R-2313	35R-2313T	Amber	Neon	250	1/3W	25,000
32RG1-2313	32RG1-2313T	Amber	Incandescent	6	.20A	5,000
32RG3-2313	32RG3-2313T	Amber	Incandescent	14	.10A	10,000
32RG18-2313	32RG18-2313T	Amber	Incandescent	28	.04A	7,000
32R-2314	32R-2314T	Blue	Neon	125	1/3W	25,000
35R-2314	35R-2314T	Blue	Neon	250	1/3W	25,000
32RG1-2314	32RG1-2314T	Blue	Incandescent	6	.20A	5,000
32RG3-2314	32RG3-2314T	Blue	Incandescent	14	.10A	10,000
32RG18-2314	32RG18-2314T	Blue	Incandescent	28	.04A	7,000
32R-2315	32R-2315T	White	Neon	125	1/3W	25,000
35R-2315	35R-2315T	White	Neon	250	1/3W	25,000
32RG1-2315	32RG1-2315T	White	Incandescent	6	.20A	5,000
32RG3-2315	32RG3-2315T	White	Incandescent	14	.10A	10,000
32RG18-2315	32RG18-2315T	White	Incandescent	28	.04A	7,000
32R-2317	32R-2317T	Clear	Neon	125	1/3W	25,000
35R-2317	35R-2317T	Clear	Neon	250	1/3W	25,000
32RG1-2317	32RG1-2317T	Clear	Incandescent	6	.20A	5,000
32RG3-2317	32RG3-2317T	Clear	Incandescent	14	.10A	10,000
32RG18-2317	32RG18-2317T	Clear	Incandescent	28	.04A	7,000

Indicator Lights