

Inductive Sensors

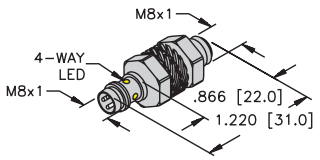
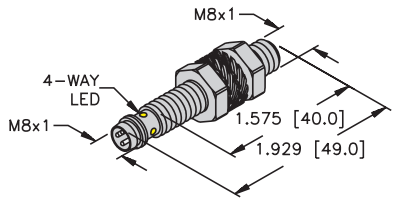
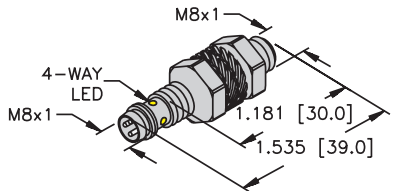
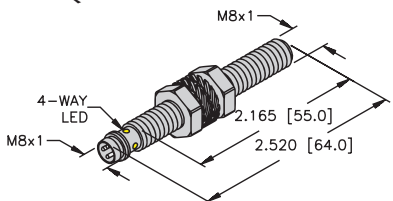
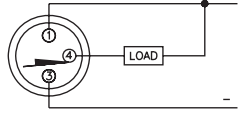
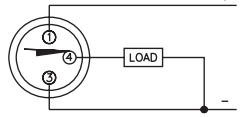
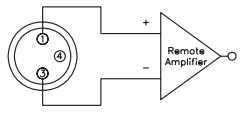

Housing Style	Part Number	ID Number	Features	Sensing Range (mm)	Output	
8 mm - Embeddable, Miniature Threaded, picofast® Quick Disconnect 	Bi 1.5-EG08K-AN6X-V1131	S4672540	Short Barrel	1.5	3-Wire DC NPN	
	Bi 2-EG08K-AN6X-V1131	S4669550	Short Barrel	2		
	Bi 1.5-EG08K-AP6X-V1131	S4672440	Short Barrel	1.5	3-Wire DC PNP	
	Bi 2-EG08K-AP6X-V1131	S4669450	Short Barrel	2		
	Bi 2-EG08K-AP6X-V1131/S957*	S4669452			2	
Bi 1.5-EG08K-Y1-V1131	S1003630	Short Barrel	1.5	2-Wire DC NAMUR		
8 mm - Embeddable, Miniature Threaded, picofast Quick Disconnect 	Bi 1.5-EG08-AN6X-V1131	S4602350		1.5	3-Wire DC NPN	
	Bi 1.5U-EG08-AN6X-V1131	S4600530	Uprox	1.5		
	Bi 2-EG08-AN6X-V1131	S4602150	Ext. Range	2		
	Bi 2U-EG08-AN6X-V1131	S4602036	Uprox	2		
	Bi 1.5-EG08-AP6X-V1131	S4602220			1.5	3-Wire DC PNP
	Bi 1.5U-EG08-AP6X-V1131	S4600520	Uprox	1.5		
	Bi 2-EG08-AP6X-V1131	S4602050	Ext. Range	2		
	Bi 2-EG08-AP6X-V1131/S1589	S4602050-1	weldguard®	2		
Bi 2U-EG08-AP6X-V1131	S4602033			2		
Bi 1.5-EG08-Y1-V1131	S1003530			1.5	2-Wire DC NAMUR	
8 mm - Embeddable, Miniature Threaded, picofast Quick Disconnect 	Bi 2-G08K-AP6X-V1131	S4672803	Ext. Range	2	3-Wire DC PNP	
8 mm - Embeddable, Miniature Threaded, picofast Quick Disconnect 	Bi 2-G08-AP6X-V1131	S4602002			3-Wire DC PNP	

* Full flush mounting in steel without reducing 2 mm sensing range.

Voltage	Switching Freq. (Hz)	Operating Current (mA)	Operating Temp. (°C)	Protection	Housing	Face	Power LED	Output LED	Mating Cordset	Wiring Diagram #	Wiring Diagrams
10-30 VDC	3000	≤150	-25 to +70	IP 67	SS	PA 12	N/A	YE	PKG 3Z-*	1	<div style="border: 1px solid black; padding: 5px; margin-bottom: 5px;"> Diagram 1  </div> <div style="border: 1px solid black; padding: 5px; margin-bottom: 5px;"> Diagram 2  </div> <div style="border: 1px solid black; padding: 5px;"> Diagram 3  </div>
	3000	≤150	-25 to +70	IP 67	SS	PA 12	N/A	YE	PKG 3Z-*	1	
10-30 VDC	3000	≤150	-25 to +70	IP 67	SS	PA 12	N/A	YE	PKG 3Z-*	2	
	3000	≤150	-25 to +70	IP 67	SS	PA 12	N/A	YE	PKG 3Z-*	2	
	3000	≤150	-25 to +70	IP 67	SS	PA 12	N/A	YE	PKG 3Z-*	2	
5-30 VDC	5000	Remote	-25 to +70	IP 67	SS	PA 12	N/A	N/A	PKG 3Z-*	3	
10-30 VDC	3000	≤150	-25 to +70	IP 67	SS	PA 12	N/A	YE	PKG 3Z-*	1	
	2000	≤150	-30 to +85	IP 68	SS	PA 12	N/A	YE	PKG 3Z-*	1	
	3000	≤150	-25 to +70	IP 67	SS	PA 12	N/A	YE	PKG 3Z-*	1	
	1000	≤150	-30 to +85	IP 68	SS	PA 12	N/A	YE	PKG 3Z-*	1	
10-30 VDC	3000	≤150	-25 to +70	IP 67	SS	PA 12	N/A	YE	PKG 3Z-*	2	
	2000	≤150	-30 to +85	IP 68	SS	PA 12	N/A	YE	PKG 3Z-*	2	
	3000	≤150	-25 to +70	IP 67	SS	PA 12	N/A	YE	PKG 3Z-*	2	
	3000	≤150	-25 to +70	IP 67	SS	WG	N/A	YE	PKG 3Z-*	2	
	1000	≤150	-30 to +85	IP 68	SS	PA 12	N/A	YE	PKG 3Z-*	2	
5-30 VDC	5000	Remote	-25 to +70	IP 67	SS	PA 12	N/A	N/A	PKG 3Z-*	3	
10-30 VDC	3000	≤150	-25 to +70	IP 67	SS	PBT	N/A	YE	PKG 3Z-*	2	
10-30 VDC	3000	≤150	-25 to +70	IP 67	SS		N/A	YE	PKG 3Z-*	2	

* Length in meters.

WIRING DIAGRAM

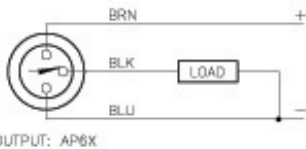

SHORT-CIRCUIT AND OVERLOAD PROTECTED

LOCKNUT LN-SS8

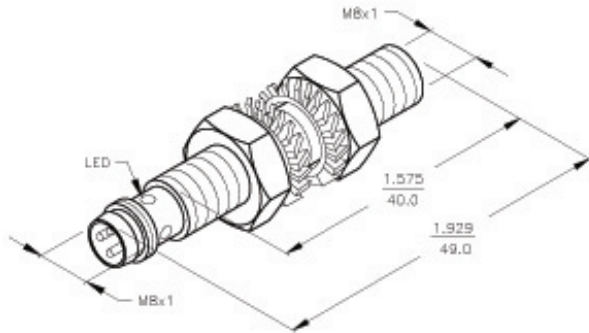
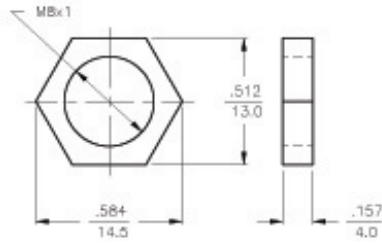

SPECIFICATIONS

OPERATING VOLTAGE	10-30 VDC
RIPPLE	≤ 10%
DIFFERENTIAL TRAVEL (HYSTERESIS)	1-15% (5% TYPICAL)
VOLTAGE DROP ACROSS CONDUCTING SENSOR	≤ 1.8 V at 150 mA
OUTPUT FUNCTION	NORMALLY OPEN 3-WIRE DC SELF-CONTAINED
TTL COMPATIBLE	NO
SHORT-CIRCUIT PROTECTED	YES
TRIGGER CURRENT FOR OVERLOAD PROTECTION	≥ 170 mA
CONTINUOUS LOAD CURRENT	≤ 150 mA
OFF-STATE (LEAKAGE) CURRENT	< 10µ A
NO-LOAD CURRENT	5.5-9.5 mA
TIME DELAY BEFORE AVAILABILITY	≤ 8 ms
POWER-ON EFFECT PROTECTION	INCORPORATED
REVERSE POLARITY PROTECTION	INCORPORATED
WIRE-BREAK PROTECTION	INCORPORATED
PROTECTION AGAINST TRANSIENTS	EN 60947-5-2
OPERATING TEMPERATURE	-25°C to +70°C (-13°F to +158°F)
ENCLOSURE	MEETS NEMA 1, 3, 4, 6, 13 AND IEC IP67
SHOCK	30 g, 11 ms
VIBRATION	55 Hz, 1 mm AMPLITUDE (IN ALL 3 PLANES)
LED FUNCTION	RED: OUTPUT ENERGIZED
RATED OPERATING DISTANCE(Sn)	2 mm = .078" (NOMINAL)
SWITCHING FREQUENCY	3000 Hz
REPEATABILITY	≤ 2% of RATED OPERATING DISTANCE
EMBEDDABLE (SHIELDED)	YES
MATING PLUGS/CABLES	3-PIN "PICOFAST" CONSTRUCTION

RELATED DOCUMENTS 1. 2. 3. 4.	3RD ANGLE PROJECTION 	THIS DRAWING IS PROPERTY OF TURCK INC. USE OF THIS DOCUMENT WITHOUT WRITTEN PERMISSION IS PROHIBITED.		TURCK INC High Technology Sensors and Automation Controls	
	MATERIAL STAINLESS STEEL	TOLERANCES UNLESS OTHERWISE SPECIFIED .X ± 0.02 .XX ± 0.01 .XXX ± 0.005 ANGLES ± 1° ALL MILLIMETER DIMENSIONS ARE REFERENCE ONLY	DWT IK USDR	DATE 3/24/87 SCALE NONE	DESCRIPTION Bi 2-EG08-AP6X-V1131
A DRAWING RELEASE RDS 11/04/02 5904	BY DATE EDO NO.	UNIT OF MEASUREMENT INCH [MILLIMETER]		IDENTIFICATION NO. S4602050	REV A
REV DESCRIPTION	BY DATE EDO NO.	DO NOT SCALE THIS DRAWING		FILE: S4602050	SHEET 1 OF 1