

# Series GFT/GB 7/16" (11.11mm) Center-to-Center Spacing

Single Row

BARRIER STYLE

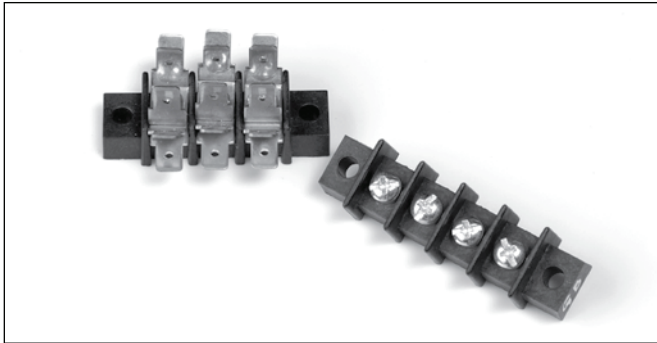
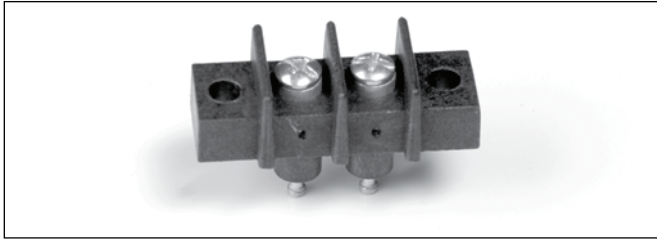

## Series GFT/GB Variations

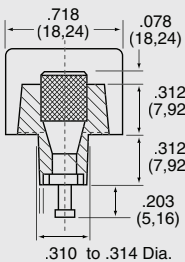

**GTX**  
turret-type  
solder  
pin

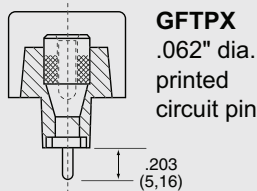

**GFTPX**  
.062" dia.  
printed  
circuit pin

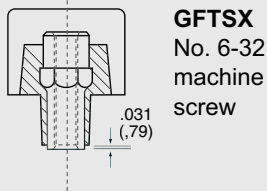

**GFTSX**  
No. 6-32  
machine  
screw

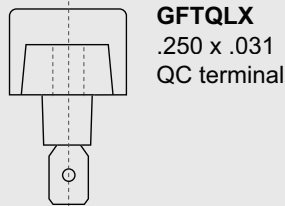

**GFTQLX**  
.250 x .031  
QC terminal

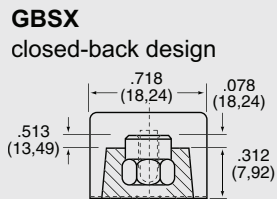

**GBSX**  
closed-back design

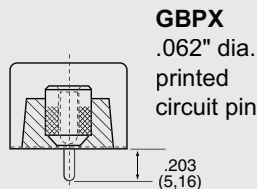

**GBPX**  
.062" dia.  
printed  
circuit pin

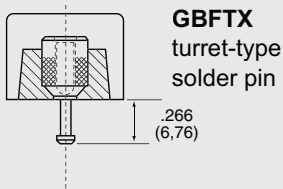

**GBFTX**  
turret-type  
solder pin

## Features:

- **Superior Construction** – All terminals are molded in place with precision screw machined brass inserts which will not twist, virtually eliminating broken solder joints while providing a full mechanical thread system.
- **Ideal for Sub-Chassis or Thru-Panel Application** – No costly insulation or mounting set-up since feed-thru insulators are an integral part of the moldings. Feature provides a full 1/4" terminal to ground clearance even thru 1/16" chassis.
- **Durable Base Material** – Made of black thermo-set phenolic, or high-impact, break-resistant thermoplastic
- **Electrical Rating** – 20A up to 600V
- **Compact Barrier-Type Design** – Especially suited for electronic and control applications
- **Feed-Thru, Printed Circuit or Surface Connection** – One thru 26 terminals on 7/16" center-to-center spacing
- **Broad Wire Range** – UL recognized for No. 22AWG to No. 12AWG, depending on type of external contact designated, with CSA requiring use of lugs on wire larger than No. 16AWG.
- **Terminal Flexibility** – External terminals available in two screw sizes with various internal terminal types
- **Recognition and Listing** – UL recognized and CSA certified



Recognized under the Components Program of Underwriters Laboratories, Inc. Standard 1059, Guide No. XCFR2, File No. E62557.



Guide No. 22.2 No. 158, Report No. LR39186-1.

## INTERNAL TERMINAL DESIGNATIONS

- GFTP** Printed circuit board design with .062" dia. tin-plated brass turret-type solder pin
- GFT** Tin-plated brass turret-type solder pin
- GFTS** Unplated brass insert. No. 6-32 plated steel screw.
- GBS** Unplated brass insert. Closed-back design which can be mounted on metal surface with no additional insulation required.
- GBP** Printed circuit board design with .062" dia. tin plated brass pin.
- GBFT** Tin-plated brass turret-type solder pin.
- GFTQX** .250 x .031 tin-plated brass quick connect tab terminal.

## EXTERNAL TERMINAL DESIGNATIONS

- GBFT, GBP,** Screw terminal with No. 6-32 plated steel\*
- GBS, GFT, GFTP** Screw accepting up to No. 12AWG wire
- GBFTA, GBPA,** Screw terminal with No. 8-32 plated steel\* screw accepting up to No. 12AWG wire
- GBSA, GFTA,**
- GFTSA, GFTPA**

\* Other materials available – contact factory or your local representative for additional information.



**Specifications:**

**Center-to-Center Spacing:** 7/16" (11.11mm)  
**Wire Range:** No. 22AWG to No. 12AWG (CSA requires use of lugs on wire larger than No. 16AWG.)  
**No. of Terminals:** 1 thru 26  
**Voltage Rating:**  
 CSA – 300 volts  
 UL – \*150 volts – General Industrial  
     \*\*250 volts – Commercial Applications  
     300 volts – Limited Energy Applications  
     600 volts – Limited Energy Applications  
 \* GFT, GFTP, GFTS, GFTAL rated for 300 volts.  
 \*\* GFTQALX rated for 125 volts.

**Tightening Torque:**

Wire Binding Screw 9 in.-lb.  
 Wire Clamp 9 in.-lb.

**Current Rating:** 20 amps, UL and CSA

<b>Housing:</b>	<b>Standard</b>	<b>"X" Grade</b>
Material	Phenolic	Polyphenylene Oxide
Continuous Use Temp. (UL Index)	150°C (302°F)	110°C (230°F)
Flammability Rating	94V-0	94V-0
Water Absorption (24 hrs. % wt. gain)	.04%	.06%

<b>Breakdown Voltage:</b>	<b>GFT</b>	<b>GB</b>
Terminal - Terminal	3,600V Typ.	5,000V Typ.
Terminal - Ground	5,800V Typ.	7,900V Typ.

Note: Specifications contained herein are subject to change without notice.

**How to Order**

GB/GFT Series terminal blocks are ordered by listing a composite number made up of the model designation followed by the number of poles required for the application. Example: Type GBP 10-pole block becomes stock number GBP-10. Suffixes are used as follows:

- A denotes model with No. 8-32 external screw terminal
- C denotes model less mounting positions
- X denotes model with thermoplastic molding

To specify quick-connect terminals, simply add the style number required. May be purchased factory-assembled or as customer-installed accessory.

The GBP-10 described above – made from thermo-set phenolic – less mounting positions thus converts to sock number GBPC-10.

**PC BOARD DRILLING DIMENSIONS**

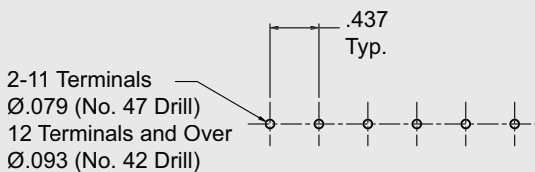

Number of Terminals	Series GFT/GB With Mounting Ends				Without Mounting Ends	
	Dimensions					
	A ± .031 Overall Dimensions (O.D.)		B ± .031 Mounting Dimensions (M.D.)		C ± .031 Less Mounting Positions	
	Inches	Metric (mm)	Inches	Metric (mm)	Inches	Metric (mm)
1	.875	22.22	1.250	31.75	.562	14.28
2	1.312	33.33	1.687	42.86	1.000	25.40
3	1.750	44.45	2.125	53.97	1.437	36.51
4	2.187	55.56	2.562	65.08	1.875	47.62
5	2.625	66.67	3.000	76.20	2.312	58.73
6	3.062	77.78	3.437	87.31	2.750	69.85
7	3.500	88.90	3.875	98.42	3.187	80.96
8	3.937	100.01	4.312	109.53	3.625	92.07
9	4.375	111.12	4.750	120.65	4.062	103.18
10	4.812	122.23	5.187	131.76	4.500	114.30
11	5.250	133.35	5.625	142.87	4.937	125.41
12	5.687	144.46	6.062	153.98	5.375	136.52
13	6.125	155.57	6.500	165.10	5.812	147.63
14	6.562	166.68	6.937	176.21	6.250	158.75
15	7.000	177.80	7.375	187.32	6.687	169.86
16	7.437	188.91	7.812	198.43	7.125	180.97
17	7.875	200.02	8.250	209.55	7.562	192.08
18	8.312	211.13	8.687	220.66	8.000	203.20
19	8.750	222.25	9.125	231.77	8.437	214.31
20	9.187	233.36	9.562	242.88	8.875	225.42
21	9.625	244.47	10.000	254.00	9.312	236.53
22	10.062	255.58	10.437	265.11	9.750	247.65
23	10.500	266.70	10.875	276.22	10.187	258.76
24	10.937	277.81	11.312	287.33	10.625	269.87
25	11.375	288.92	11.750	298.45	11.062	280.98
26	11.812	300.03	12.187	309.56	11.500	292.10

Dimensions shown are ± 0.030"

**Series GFT/GB with Mounting Ends**

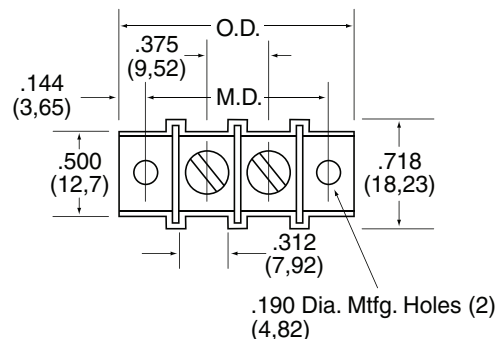

# Series GB/GFT

## Series GFT/GB Accessories

### QUICK-CONNECT TERMINALS

GFT-GFT – Available with .250" x .032" quick-connect tabs of tin-plated brass, held in place by terminal screws. Six styles . . . one to six terminations per pole. Factory-assembled or customer installed. Last digit of part number corresponds to previous style numbers.

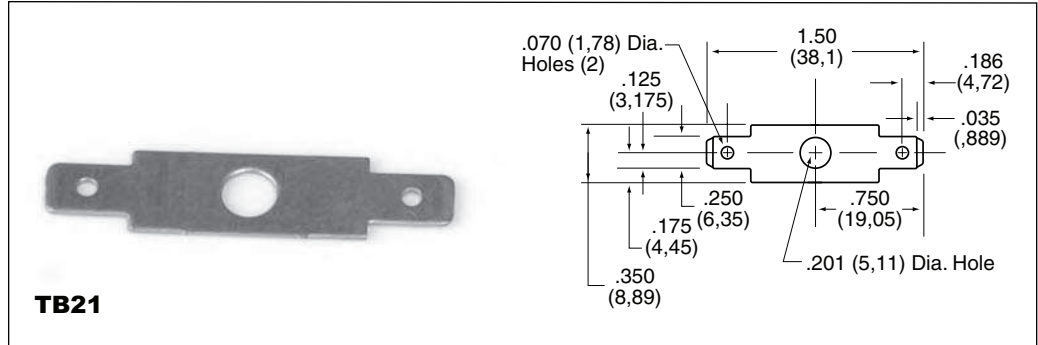

**TB21**

Single Row

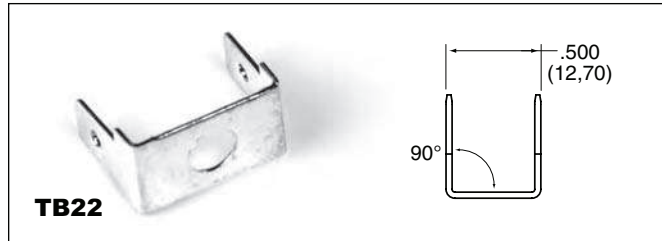

**TB22**

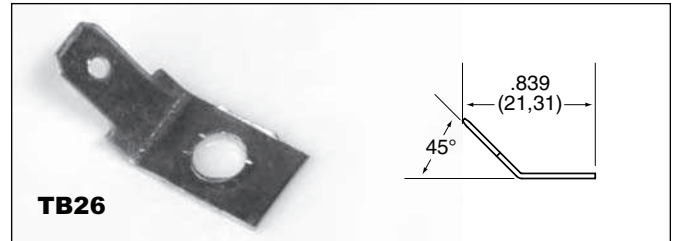

**TB26**

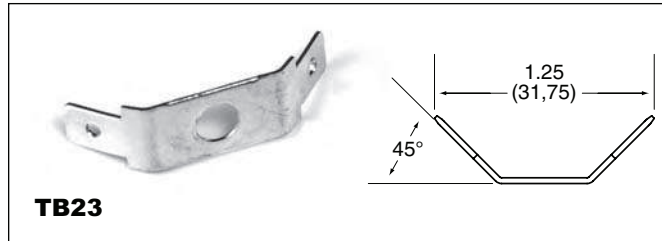

**TB23**

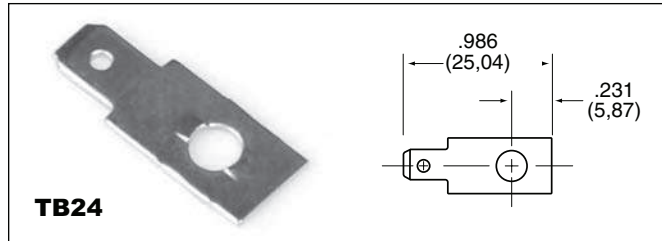

**TB24**

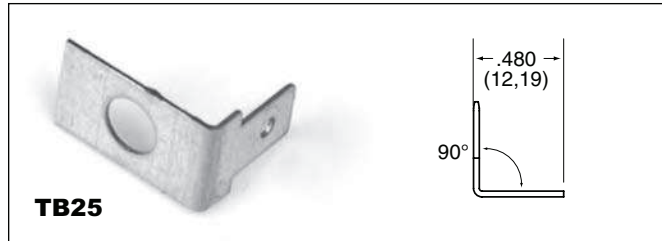

**TB25**

BARRIER STYLE



**TINNERMAN NUT**

GFT – for speed mounting of terminal blocks less mounting position.

Part No. TN-437.

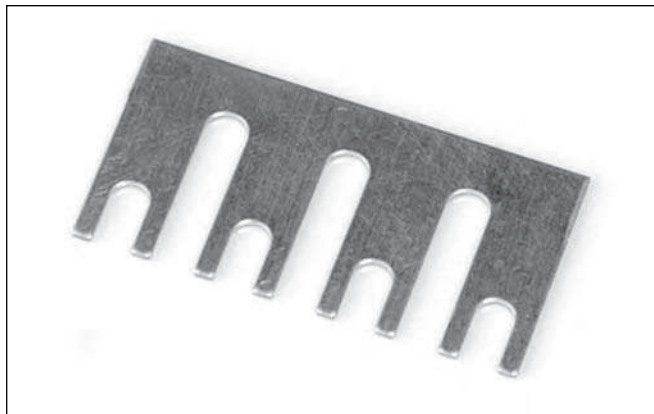
**TERMINAL BLOCK JUMPERS**

GB/GFT – Plated in two styles. Types 267A28 is designed to jump two adjacent terminals as it is channeled to cross over the barrier top. "Rooster comb" design of Type 267A42 permits connections of two to 18 poles.

To order, specify: Part No. 267A42 (plus no. of poles)

Example: 267A42-18

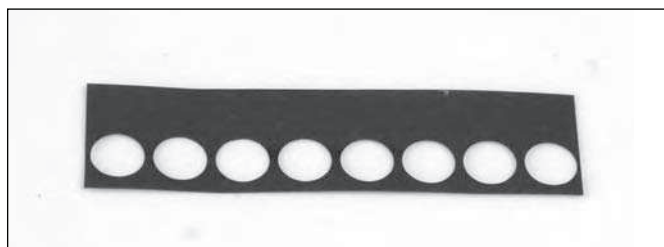
**MARKING STRIPS**

GB/GFT – Pre-punched black fiber . . . mounts under block. May be imprinted to customer specifications.

To order, specify: Part No. 267A19-1 thru 26 (with mounting hole); Part No. 267A18-1 thru 26 (less mounting hole).

**COVERS**

GB/GFT – Rigid .030" thick self-extinguishing vinyl. Black matte-finished on both sides. May double as marking strip when imprinted with white ink. Complete with spring clips for attaching to mounting positions.

Part No. 267B86-1 thru 26 terminals

