

5

4

3

2

1

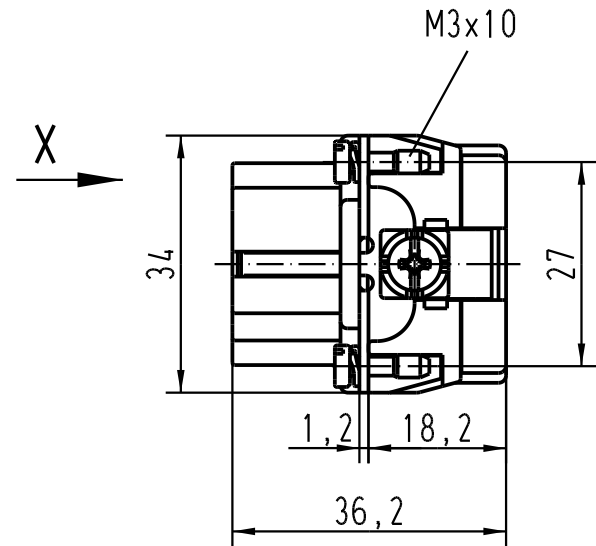
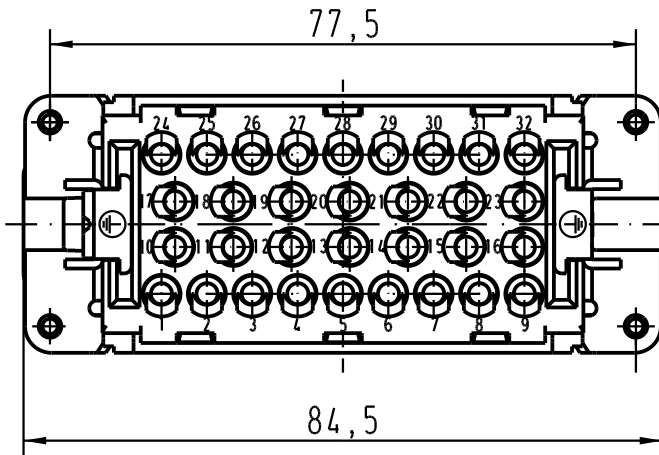

X (um 180° gedreht)

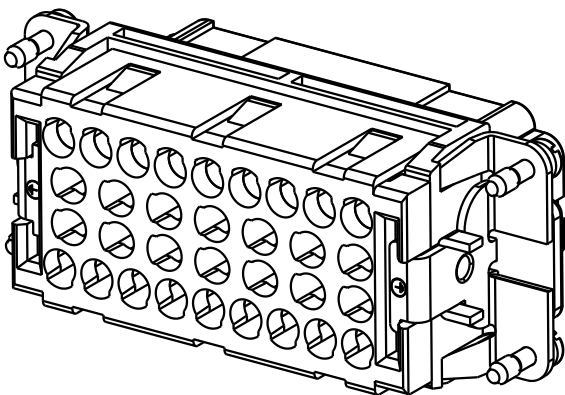
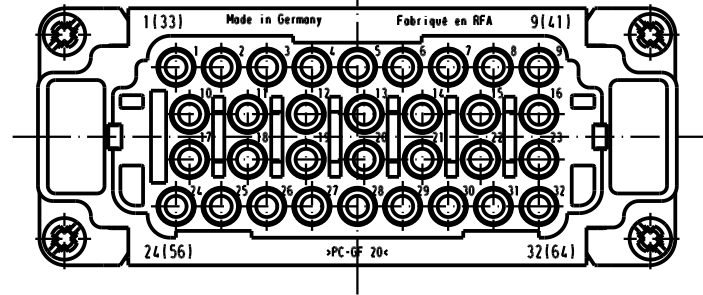

	All Dimensions in mm Original Size DIN A 4			Techn. Character.			Nicht tolerierte Masse/ Free size tolerances			
					Dat.	Name	Massstab/ Scale			
				Detail.	08.08.02	DY	2:1			
				Insp.		KR				
				Stand.						
411184	05.08.04	ML	HARTING Electric GmbH & Co. KG				TB 09 32 032 3101			Blatt/ page
410166			D-32339 Espelkamp							
Mod.	Dat.	Name				Sub. TB 09 32 032 3101 v. 18.06.99				