

VOLEX

GROUP

Standard Cord Details: 17614 10 B1

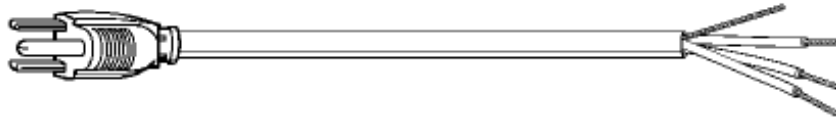

Specifications	
Certifications	
Part Number	17614 10 B1
Connector Type	none
Plug Type	5-15P
Category	Plastic
Application	Non-Detachable
Plug Catalog No.	
Connector Catalog No.	
Cable	
Jacket Color	Black
Length in Feet	6'7"
Length in Meters	2
Temperature Rating	60 C
Packaging Units Per Carton	100
Color Coding	International
Nominal OD in Inches	0.365
Nominal OD in Millimeters	9.27

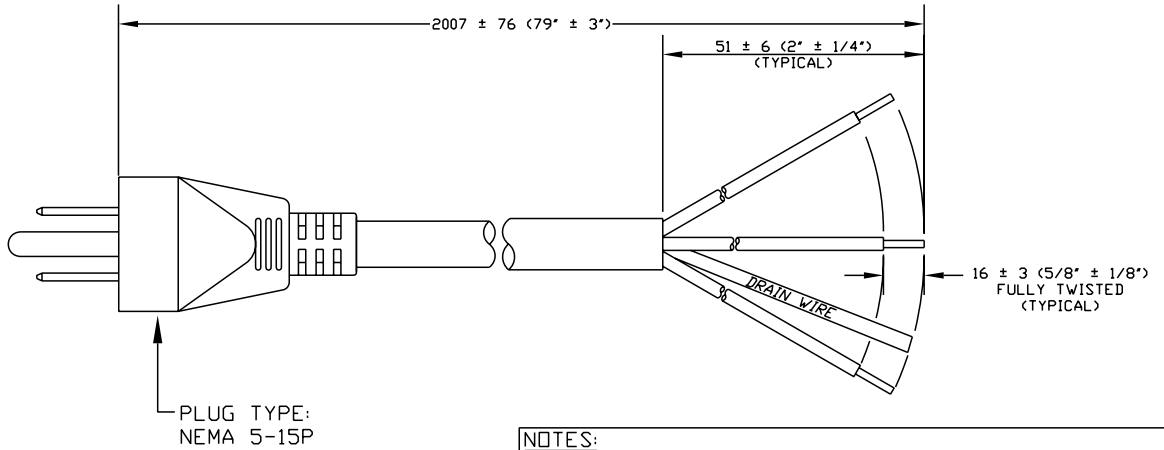
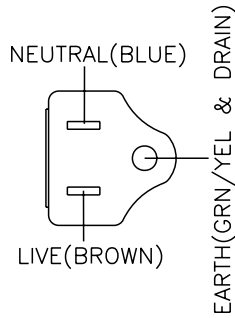

VOLEX RESERVES THE RIGHT TO ALTER NON-CRITICAL DIMENSIONS WITHOUT NOTICE.

- NOTES:
- 1) CORDAGE: 16/3, SJT, 60°C, BLACK, LEAD FREE, FOIL SHIEDED WITH DRAIN WIRE.
 - 2) APPROVALS:
 - 3) RATING: 13 AMP/125 VOLTS
 - 4) FLAME RATING : FT2
 - 5) DRAIN WIRE CONNECTED TO GROUND PIN OF PLUG PRIOR TO MOLDING.
 - 6) PACKAGING: 70 PIECES/CARTON
 - 7) ALL DIMENSIONS IN MILLIMETERS UNLESS OTHERWISE NOTED.

PACKAGING: FOLD & TIE

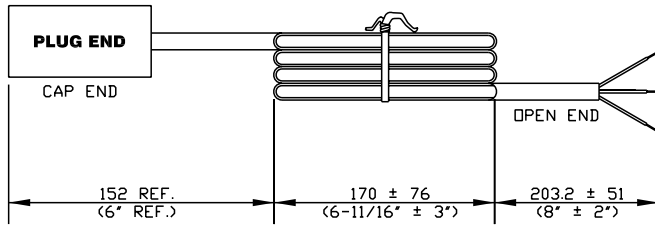

1	C.U.D - NEW RELEASE	9/5/07
REV	DESCRIPTION	DATE

	<input checked="" type="checkbox"/> Indianapolis, IN <input type="checkbox"/> Conover, N.C. <input type="checkbox"/> Freemont, CA <input type="checkbox"/> Aguascalientes, MX <input type="checkbox"/> Tijuana, Mexico <input type="checkbox"/> Hermosillo, MX <input type="checkbox"/> Clinton, AR <input type="checkbox"/> Kanata, Canada	Proprietary Notice: This document is the property of Volex Incorporated. The information contained herein is not to be disclosed to anyone without the express written consent of Volex Inc.	MATERIAL: PLUG: PVC, BLK, LEAD FREE JACKET: PVC, BLK, LEAD FREE	SCALE: NOT TO SCALE ECD: N/A	ITEM DESCRIPTION CORDSET - NORTH AMERICAN POWER SUPPLY CORD (6'7")		
	FINISH: JACKET: SMOOTH		TOLERANCE UNLESS OTHERWISE SPECIFIED .XXX ± .005 .XX ± .02 .X ± .03 FRACT. ± 1/32 ANGULAR ± 1/2°		APPROVED: STC DRAWN BY: STC DATE: 9/5/07	PART NO. 17614 10 B1	

FORM IN71-07 REV.A