

SOLID TANTALUM CHIP CAPACITORS

T495 SERIES—Low ESR, Surge Robust



Solid Tantalum Surface Mount

FEATURES

- Designed for very low ESR
- High ripple current capability
- High surge current capability
- 100% accelerated steady-state aging
- 100% Surge Current test
- Meets or Exceeds EIA Standard 535BAAC
- Available tested per DSCC Dwg. 95158
- Operating Temperature: -55°C to +125°C
- New Extended Values for Low ESR
- Low Equivalent Series Inductance (<2.5nH ESL)
- Precision-molded, laser-marked case
- Symmetrical, compliant terminations
- Taped and reeled per EIA 481-1
- RoHS Compliant & Leadfree Terminations (see www.kemet.com for lead transition)

OUTLINE DRAWING

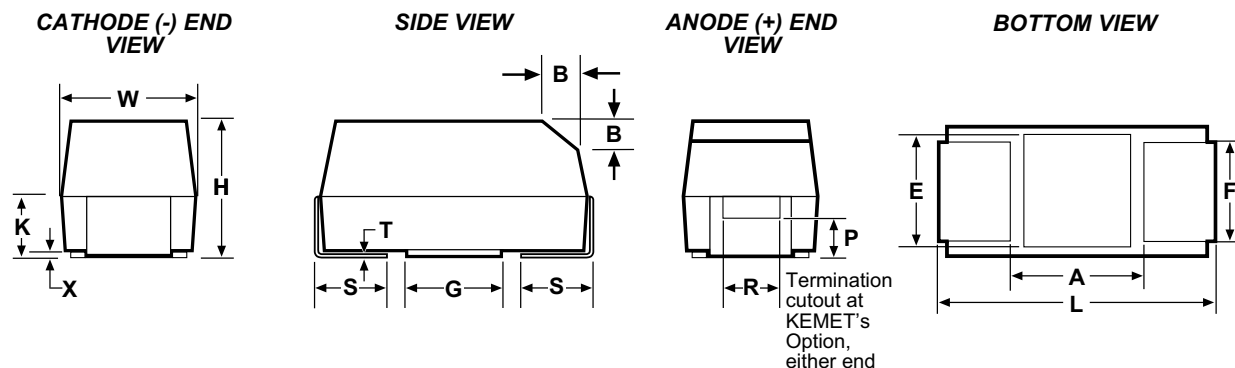

STANDARD T495 DIMENSIONS

Millimeters (Inches)

Case Size		L	W	H	K ±0.20	F ±0.1	S ±0.3	B ±0.15 (Ref) ±(.006)	X (Ref)	P (Ref)	R (Ref)	T (Ref)	A (Min)	G (Ref)	E (Ref)
KEMET	EIA														
B	3528-21	3.5 ± 0.2 (.138 ± .008)	2.8 ± 0.2 (.110 ± .008)	1.9 ± 0.1 (.075 ± .008)	1.1 (.043)	2.2 (.087)	0.8 (.031)	0.4 (.016)	0.10 ± 0.10 (.004 ± .004)	0.5 (.020)	1.0 (.039)	0.13 (.005)	2.1 (.083)	1.8 (.071)	2.2 (.087)
C	6032-28	6.0 ± 0.3 (.236 ± .012)	3.2 ± 0.3 (.126 ± .012)	2.5 ± 0.3 (.098 ± .012)	1.4 (.055)	2.2 (.087)	1.3 (.051)	0.5 (.020)	0.10 ± 0.10 (.004 ± .004)	0.9 (.0235)	1.0 (.039)	0.13 (.005)	3.1 (.122)	2.8 (.110)	2.4 (.094)
D	7343-31	7.3 ± 0.3 (.287 ± .012)	4.3 ± 0.3 (.169 ± .012)	2.8 ± 0.3 (.110 ± .012)	1.5 (.059)	2.4 (.094)	1.3 (.051)	0.5 (.020)	0.10 ± 0.10 (.004 ± .004)	0.9 (.0235)	1.0 (.039)	0.13 (.005)	3.8 (.150)	3.5 (.138)	3.5 (.138)
X	7343-43	7.3 ± 0.3 (.287 ± .012)	4.3 ± 0.3 (.169 ± .012)	4.0 ± 0.3 (.157 ± .012)	2.3 (.091)	2.4 (.094)	1.3 (.051)	0.5 (.020)	0.10 ± 0.10 (.004 ± .004)	1.7 (.067)	1.0 (.039)	0.13 (.005)	3.8 (.150)	3.5 (.138)	3.5 (.138)
E	7260-38	7.3 ± 0.3 (.287 ± .012)	6.0 ± 0.3 (.236 ± .012)	3.6 ± 0.2 (.142 ± .008)	2.3 (.091)	4.1 (.161)	1.3 (.051)	0.5 (.020)	0.10 ± 0.10 (.004 ± .004)	0.9 (.035)	1.0 (.039)	0.13 (.005)	3.8 (.150)	3.5 (.138)	3.5 (.138)

Notes: 1. Metric dimensions govern.
2. (Ref) - Dimensions provided for reference only.

LOW PROFILE T495 DIMENSIONS

Millimeters (Inches)

CASE SIZE		COMPONENT										
KEMET	EIA	L	W	H Max.	K Min.	F ± 0.1	S ± 0.3	X (Ref)	T (Ref)	A (Min)	G (Ref)	E (Ref)
T	3528-12	3.5 ± 0.2 (.138 ± .008)	2.8 ± 0.2 (.110 ± .008)	1.2 (.047)	0.3 (.012)	2.2 (.087)	0.8 (.031)	0.05 (.002)	0.13 (.005)	2.1 (.083)	1.8 (.071)	2.2 (.087)
V	7343-20	7.3 ± 0.3 (.287 ± .012)	4.3 ± 0.3 (.169 ± .012)	2.0 (0.079)	0.9 (.035)	2.4 (.094)	1.3 (.051)	0.05 (.002)	0.13 (.005)	3.8 (.150)	3.5 (.138)	3.5 (.138)

Notes: 1. Metric dimensions govern.
2. (Ref) - Dimensions provided for reference only.
3. No dimensions provided for B, P or R because low profile cases do not have a bevel or a notch.

T495 Series – ORDERING INFORMATION

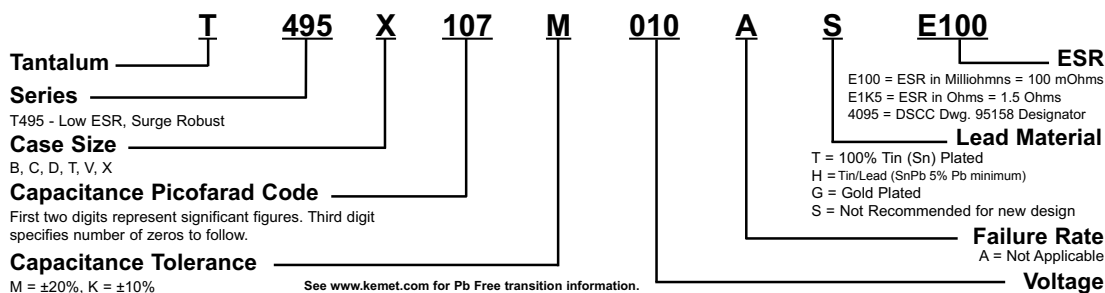

T495 RATINGS & PART NUMBER REFERENCE

Capacitance μ F	Case Size	KEMET Part Number	DSCC Dwg. No. 95158 Part Number	DC Leakage μ A @ 25°C Max	DF% @ 25°C 120 Hz Max	ESR m Ω @ 25°C 100 kHz Max	Ripple Current mA rms @ 25°C, 100 kHz Max		
							25°C	85°C	125°C
35 Volt Rating @ +85°C (23 Volt Rating at +125°C)									
0.47	B	T495B474(1)035A(2)E1K5		0.5	4.0	1500	238	214	95
0.47	B	T495B474(1)035A(2)E2K2		0.5	4.0	2200	197	177	79
1.0	A	T495A105(1)035A(2)E3K0		0.4	4.0	3000	158	142	63
1.0	B	T495B105(1)035A(2)E1K5		0.5	4.0	1500	238	214	95
1.0	B	T495B105(1)035A(2)E1K7		0.5	4.0	1700	224	201	89
2.2	B	T495B225(1)035A(2)E1K5		0.8	6.0	1500	238	214	95
2.2	C	T495C225(1)035A(2)E750		0.8	6.0	750	383	345	153
3.3	B	T495B335(1)035A(2)E900		1.2	6.0	900	307	276	123
3.3	C	T495C335(1)035A(2)E600		1.2	6.0	600	428	385	171
4.7	C	T495C475(1)035A(2)E450		1.7	6.0	450	494	445	198
4.7	C	T495C475(1)035A(2)E500		1.7	6.0	500	469	422	188
4.7	*C	T495C475(1)035A(2)E600		1.7	6.0	600	428	385	171
4.7	*C	T495C475(1)035A(2)4095	95158-29(1)2	1.7	6.0	600	428	385	171
6.8	D	T495D685(1)035A(2)E400		2.4	6.0	400	612	551	245
6.8	X	T495X685(1)035A(2)E300		1.9	4.0	300	742	667	297
6.8	X	T495X685(1)035A(2)4095	95158-20(1)2	1.9	4.0	300	742	667	297
10.0	D	T495D106(1)035A(2)E250		3.5	6.0	250	775	697	310
10.0	D	T495D106(1)035A(2)E300		3.5	6.0	300	707	636	283
10.0	D	T495D106(1)035A(2)4095	95158-27(1)2	3.5	4.0	300	707	636	283
10.0	X	T495X106(1)035A(2)E175		3.5	6.0	175	971	874	388
10.0	X	T495X106(1)035A(2)E200		3.5	6.0	200	908	817	363
10.0	X	T495X106(1)035A(2)E250		2.8	4.0	250	812	731	325
10.0	X	T495X106(1)035A(2)4095	95158-21(1)2	2.8	4.0	250	812	731	325
15.0	D	T495D156(1)035A(2)E225		5.3	6.0	225	816	735	327
15.0	*D	T495D156(1)035A(2)E300		5.3	6.0	300	707	636	283
15.0	*X	T495X156(1)035A(2)E200		5.3	6.0	200	908	817	363
15.0	*X	T495X156(1)035A(2)E225		5.3	6.0	225	856	771	343
15.0	*X	T495X156(1)035A(2)4095	95158-22(1)2	5.3	6.0	225	856	771	343
22.0	D	T495D226(1)035A(2)E200		7.7	6.0	200	866	779	346
22.0	D	T495D226(1)035A(2)E250		7.7	6.0	250	775	697	310
22.0	*D	T495D226(1)035A(2)E300		7.7	6.0	300	707	636	283
22.0	X	T495X226(1)035A(2)E200		7.7	6.0	200	908	817	363
22.0	*X	T495X226(1)035A(2)E275		7.7	6.0	275	775	697	410
22.0	*X	T495X226(1)035A(2)4095	95158-23(1)2	7.7	6.0	300	742	667	297
33.0	X	T495X336(1)035A(2)E175		11.6	6.0	175	971	874	388
33.0	*X	T495X336(1)035A(2)E250		11.6	6.0	250	812	731	325
47.0	X	T495X476(1)035A(2)E185		16.5	8.0	185	944	850	378
47.0	X	T495X476(1)035A(2)E200		16.5	8.0	200	908	817	363
47.0	*X	T495X476(1)035A(2)E300		16.5	8.0	300	742	667	297
50 Volt Rating @ +85°C (33 Volt Rating at +125°C)									
1.0	C	T495C105(1)050A(2)E1K3		0.5	4.0	1300	291	262	116
2.2	D	T495D225(1)050A(2)E600		1.1	6.0	600	500	450	200
3.3	D	T495D335(1)050A(2)E700		1.7	6.0	700	463	417	185
4.7	D	T495D475(1)050A(2)E275		2.4	6.0	275	739	665	295
4.7	D	T495D475(1)050A(2)E300		2.4	6.0	300	707	636	283
4.7	X	T495X475(1)050A(2)E300		1.9	4.0	300	742	667	297
4.7	X	T495X475(1)050A(2)4095	95158-24(1)2	1.9	4.0	300	742	667	297
6.8	D	T495D685(1)050A(2)E275		3.4	6.0	275	739	665	295
6.8	*D	T495D685(1)050A(2)E300		3.4	8.0	300	700	600	300
10.0	*X	T495X106(1)050A(2)E300		5.0	6.0	300	741	667	297
15.0	*X	T495X156(1)050A(2)E300		7.5	8.0	300	742	667	297

- (1) To complete KEMET part number, insert "K" for $\pm 10\%$ or "M" for $\pm 20\%$ capacitance tolerance.
 (2) To complete KEMET part number, insert lead material designations per Ordering Information on page 31.
 *Extended Values

Higher voltage ratings and tighter capacitance tolerance product may be substituted within the same size at KEMET's option. Voltage substitutions will be marked with the higher voltage rating.

CONSTRUCTION

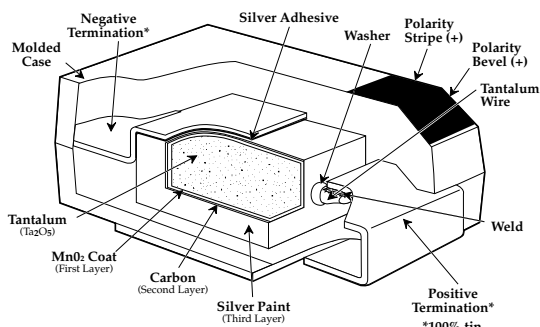

CAPACITOR MARKINGS

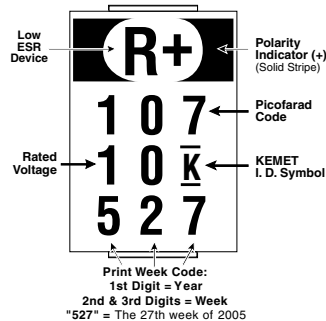

SOLID TANTALUM CHIP CAPACITORS

T495 SERIES—Low ESR, Surge Robust



Solid Tantalum Surface Mount

T495 TANTALUM CHIP CAPACITANCE VALUES

Case Size and Max. ESR (mΩ) by Capacitance & Voltage
Standard Capacitance Values

Capacitance		Rated Voltage @ +85°C								
μF	Code	2.5	4	6	10	16	20	25	35	50
0.47	474							A,4500	B,1500 B,2200	
1.0	105						A,3000		A,3000 B,1500 B,1700	C,1500
2.2	225							C,1300	B,1500 C,750	D,600
3.3	335					A,3000		C,750	B,900 C,600	D,700
4.7	475				A,1300 B,1300	A,2000 B,700		C,575	C,450,500 C,600	D,275,300 X,300
6.8	685				A,1800 B,900	C,750		B,1500 C,400,490,500	D,400 X,300	D,275,300
10.0	106				B,750	T,4000	B,1000 C,400,475	C,450	D,250,300 X,175,200 X,250	X,300
15.0	156				B,500 C,375,400	B,800	C,375 D,275	D,275 X,200	D,225,300 X,200,225	X,300
22.0	226				V,70 C,290,345		D,180,225 D,275	C, 300,900 D,200 X,225	D,200,250 D300 X,200,275, 300	
33.0	336				B,450 V,100,150	C,225,275 D,150,175, D,225,250	D,100,150,200	D,90,100 D,225,300 X,175	X,175,250	
47.0	476			B,450 C,250 V,150	D,80,90, 200	C,350 D,100,150, 200	D,100,175 X,65,100 X,125,150	D,120,250 X,150,185, 200	X,185,200, 300	
68.0	686		V,150	D,175	V,100,140 B,600,750 B,900 C,225 D,90,150 X,150	V,180,300 D,150	D,150 X,120,150	X,125,150 200		
100.0	107	T, 3000	B,500	V,90,150 B,400,700 C,150 D,150	V,150 D,65, 80,100 X,100	D,100,125 X,80,100, 125	X,150 E,85,100 200			
150.0	157		B,900 C,250	V,70 C,200 X,100,125	D,80,100 X,85,100 V,100,150	X,75,100				
220.0	227	D,45		C,225 D,45,100 X,50, 60,70, 100	V,150 D,45,75 D,100,125 X, 45,70, 100	E,100,150				
330.0	337		C,300,700 D,30,45	X,35,45,65, X,100 D,40,50,70, D,100 E,40,60,100	D,125 X,50,60 E,60,100					
470.0	477			X,30,45,50, X,65 D,100,125 E,55,100						
680.0	687									
1000.0	108	X,40	X,70 E,35,50	E,50						

Note that standard values are preferred, especially where high surge currents are possible. Extended values are available to increase capacitance and reduce ESR. Note that standard CV values demonstrate inherently lower failure rates than extended CV values, especially in low impedance applications.

Tape & Reel Packaging

KEMET's Molded Tantalum and Aluminum Chip Capacitor families are packaged in 8 mm and 12 mm plastic tape on 7" and 13" reels, in accordance with EIA Standard 481-1: Taping of Surface Mount Components for Automatic Handling. This packaging system is compatible with all tape fed automatic pick and place systems.

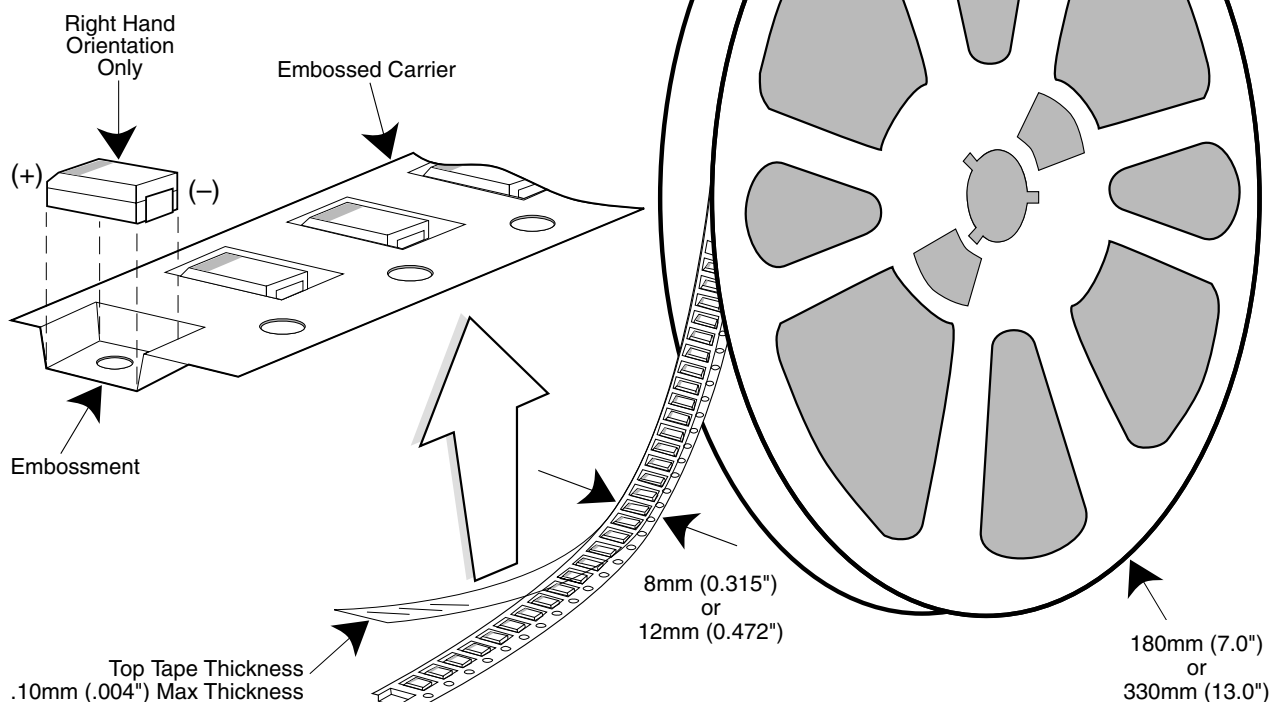

Labeling: Bar code labeling (standard or custom) shall be on the side of the reel opposite the sprocket holes. Refer to EIA-556.

QUANTITIES PACKAGED PER REEL

Case Code		Tape Width-mm	7" Reel*	13" Reel*
KEMET	EIA			
R	2012-12	8	2,500	10,000
S	3216-12	8	2,500	10,000
T	3528-12	8	2,500	10,000
U	6032-15	12	1,000	5,000
W	7343-15	12	1,000	3,000
V	7343-20	12	1,000	3,000
A	3216-18	8	2,000	9,000
B	3528-21	8	2,000	8,000
C	6032-28	12	500	3,000
D	7343-31	12	500	2,500
Y	7343-40	12	500	2,000
X	7343-43	12	500	2,000
E	7260-38	12	500	2,000

* No c-spec required for 7" reel packaging. C-7280 required for 13" reel packaging.

TANTALUM, CERAMIC AND ALUMINUM CHIP CAPACITORS



Packaging Information

Performance Notes

- Cover Tape Break Force:** 1.0 Kg Minimum.
- Cover Tape Peel Strength:** The total peel strength of the cover tape from the carrier tape shall be:

Tape Width	Peel Strength
8 mm	0.1 Newton to 1.0 Newton (10g to 100g)
12 mm	0.1 Newton to 1.3 Newton (10g to 130g)

The direction of the pull shall be opposite the direction of the carrier tape travel. The pull angle of the carrier tape shall be 165° to 180° from the plane of the carrier tape. During peeling, the carrier and/or cover tape shall be pulled at a velocity of 300 ±10 mm/minute.

- Reel Sizes:** Molded tantalum capacitors are available on either 180 mm (7") reels (standard) or 330 mm (13") reels (with C-7280). Note that 13" reels are preferred.
- Labeling:** Bar code labeling (standard or custom) shall be on the side of the reel opposite the sprocket holes. Refer to EIA-556.

Embossed Carrier Tape Configuration: Figure 1

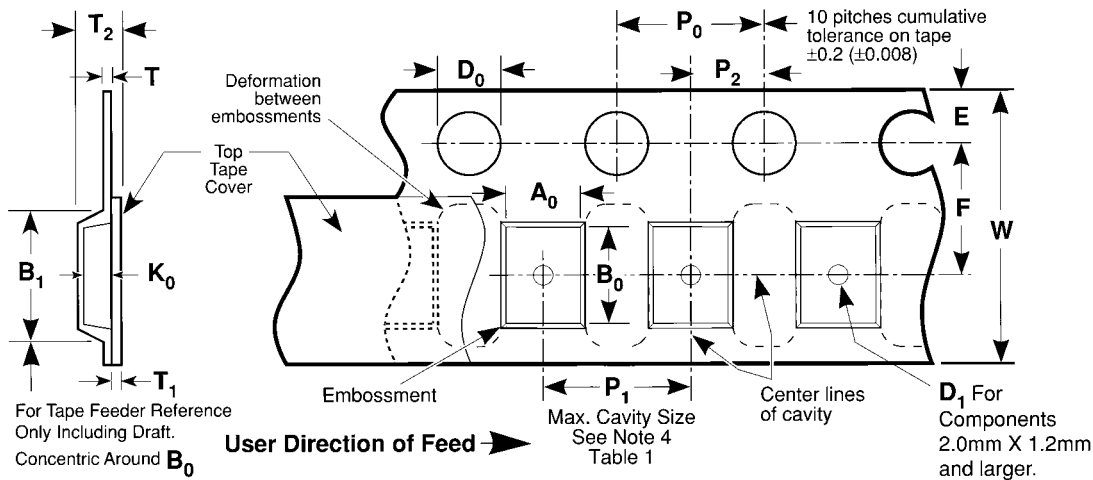

Table 1 — EMBOSSED TAPE DIMENSIONS (Metric will govern)

Constant Dimensions — Millimeters (Inches)									
Tape Size	D ₀	E	P ₀	P ₂	T Max	T ₁ Max			
8 mm and 12 mm	1.5 +0.10 -0.0 (0.059 +0.004, -0.0)	1.75 ±0.10 (0.069 ±0.004)	4.0 ±0.10 (0.157 ±0.004)	2.0 ±0.05 (0.079 ±0.002)	0.600 (0.024)	0.100 (0.004)			
Variable Dimensions — Millimeters (Inches)									
Tape Size	Pitch	B ₁ Max. Note 1	D ₁ Min. Note 2	F	P ₁	R Min. Note 3	T ₂ Max	W	A ₀ B ₀ K ₀ Note 4
8 mm	Single (4 mm)	4.4 (0.173)	1.0 (0.039)	3.5 ±0.05 (0.138 ±0.002)	4.0 ±0.10 (0.157 ±0.004)	25.0 (0.984)	2.5 (0.098)	8.0 ±0.30 (.315 ±0.012)	
12 mm	Double (8 mm)	8.2 (0.323)	1.5 (0.059)	5.5 ±0.05 (0.217 ±0.002)	8.0 ±0.10 (0.315 ±0.004)	30.0 (1.181)	4.6 (0.181)	12.0 ±0.30 (0.472 ±0.012)	

NOTES

- B1 dimension is a reference dimension for tape feeder clearance only.
- The embossment hole location shall be measured from the sprocket hole controlling the location of the embossment. Dimensions of embossment location and hole location shall be applied independent of each other.
- Tape with components shall pass around radius "R" without damage (see sketch A). The minimum trailer length (Fig. 2) may require additional length to provide R min. for 12 mm embossed tape for reels with hub diameters approaching N min. (Table 2)
- The cavity defined by A₀, B₀, and K₀ shall be configured to surround the part with sufficient clearance such that the chip does not protrude beyond the sealing plane of the cover tape, the chip can be removed from the cavity in a vertical direction without mechanical restriction, rotation of the chip is limited to 20 degrees maximum in all 3 planes, and lateral movement of the chip is restricted to 0.5 mm maximum in the pocket (not applicable to vertical clearance.)

Embossed Carrier Tape Configuration (cont.)

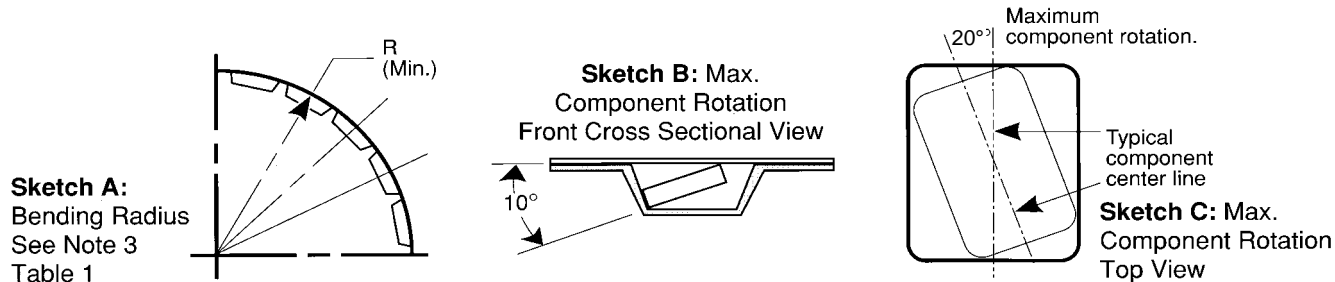

Sketch D: Tape Camber (Top View)

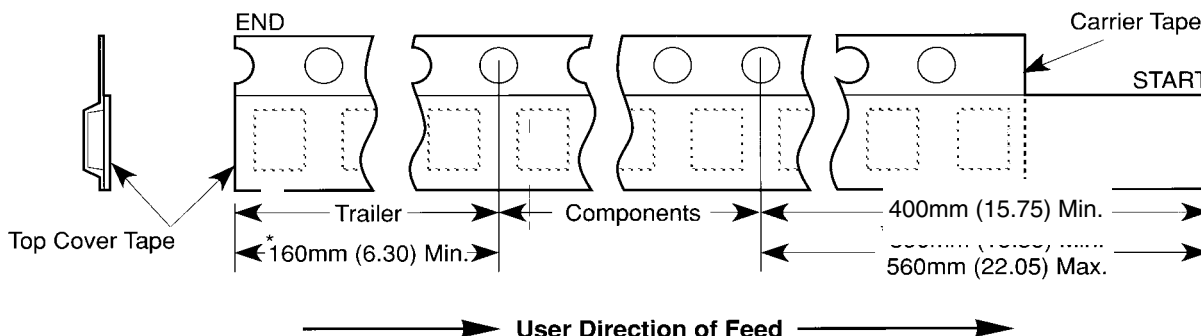
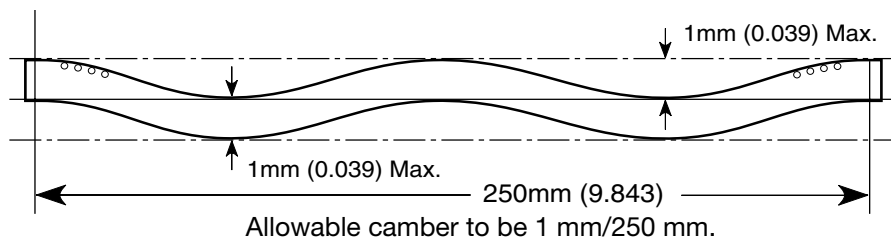

Figure 2:
Tape Leader
& Trailer
Dimensions
(Metric
Dimensions
Will Govern)

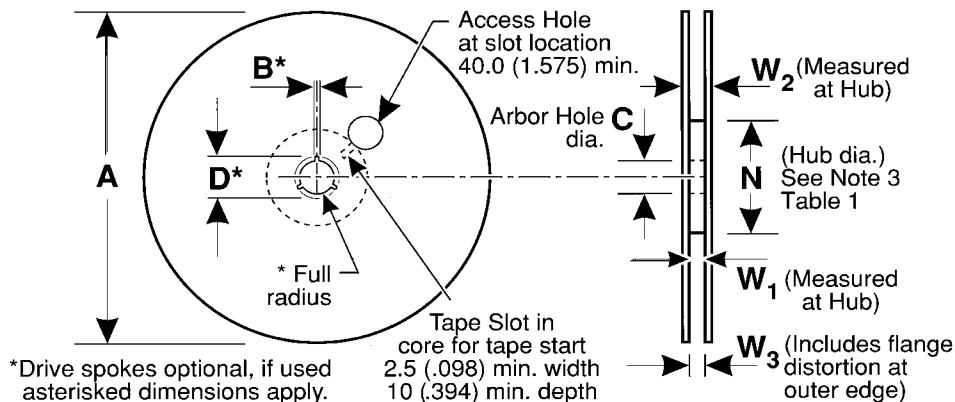

Figure 3: Reel Dimensions (Metric Dimensions will govern)

Table 2 – REEL DIMENSIONS (Metric will govern)

Tape Size	A Max	B* Min	C	D* Min	N Min	W_1	W_2 Max	W_3
8 mm	330.0 (12.992)	1.5 (0.059)	13.0 ± 0.20 (0.512 ± 0.008)	20.2 (0.795)	50.0 (1.969) See Note 3	8.4 +1.5, -0.0 (0.331) +0.059, -0.0)	14.4 (0.567)	7.9 Min (0.311) 10.9 Max (0.429)
12 mm	330.0 (12.992)	1.5 (0.059)	13.0 ± 0.20 (0.512 ± 0.008)	20.2 (0.795)	Table 1	12.4 +2.0, -0.0 (0.488) +0.078, -0.0)	18.4 (0.724)	11.9 Min (0.469) 15.4 Max (0.606)