

## Relays and Timers

## Contents

<i>Description</i>	<i>Page</i>
catalogue Number Selection .....	<b>B-3</b>
Product Selection .....	<b>B-4</b>
Accessories .....	<b>B-5</b>
Technical Data and Specifications .....	<b>B-10</b>
Dimensions .....	<b>B-13</b>
Reference Data .....	<b>B-162</b>

B



## Product Description

Eaton's new line of **XT** Relays and Timers includes mini and standard frame control relays and auxiliary contacts, mini electronic on-delay and multi-function timers and an electronic star-delta (wye-delta) timer for use in star-delta (wye-delta) combinations. Because **XT** meets UL, CSA, CCC and CE standards, it is the perfect product solution for IEC applications all over the world. The compact, space saving, and easy to install **XT** line of IEC contactors and starters is the efficient and effective solution for customer applications.

## Features

- For use with Mini and Standard frame size contactors and starters
- Control Relays
  - AC Control from 12V to 550V 50 Hz, 600V 60 Hz
  - DC Control from 12V to 220V
- On-Delay and Multi-Function Timers
  - 24 – 240V AC/DC Control
- Available with screw or spring cage terminals
- 4-Pole Configurations
- IP20 finger and back-of-hand proof
- Large ambient temperature range: -25° to 50°C [-13° to 122°F]
- The XTRE Control Relays have positively driven contacts between the relay and the auxiliary contact modules as well as within the auxiliary contact modules

## Standards and Certifications

- IEC EN 60947
- CE Approved
- UL
- CSA
- CCC
- ATEX

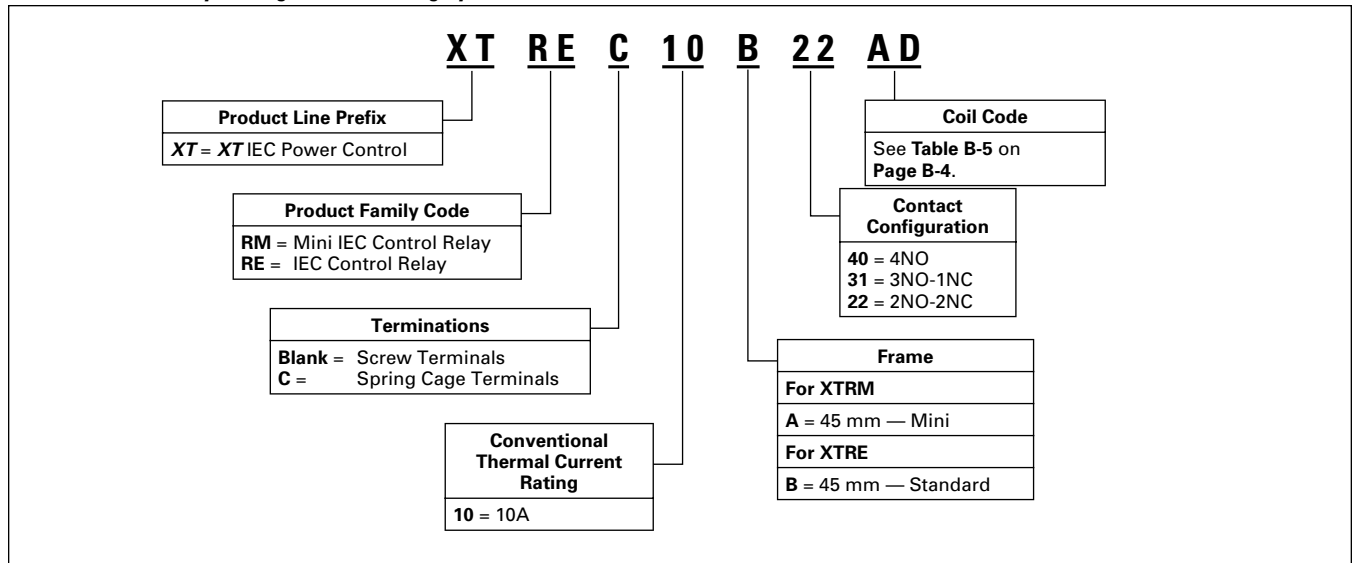


## Instructional Leaflets

Pub51219	Inside of Packaging XTRM Mini Control Relays
Pub51210	Inside of Packaging 7-15A XTCE Contactors and XTRE Control Relays
Pub51244	XTTR Electronic Star-Delta (Wye-Delta) Timer
Pub51245	XTMT Mini Electronic On-Delay and Multi-Function Timers

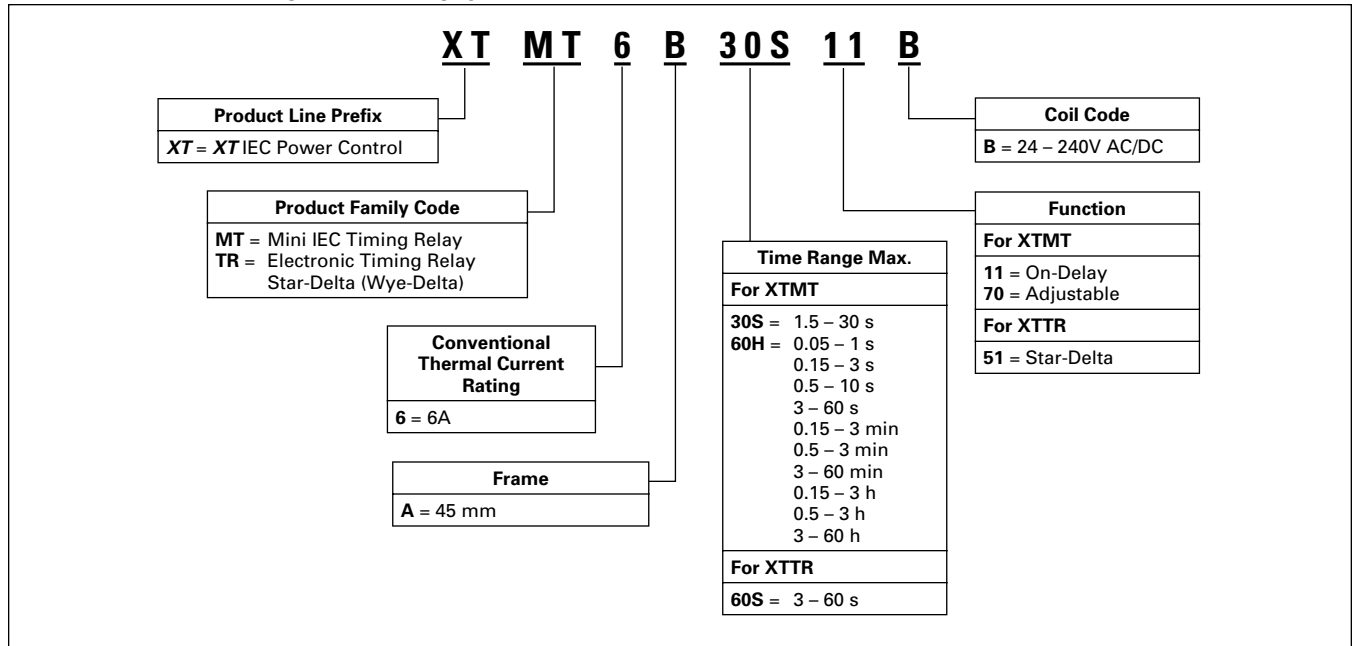
**catalogue Number Selection**

**Table B-1. XT— Relay catalogue Numbering System**



**B**

**Table B-2. XT— Timers catalogue Numbering System**



**Product Selection**



**B**

**Mini Control Relays**

Table B-3. Mini Control Relays

Conventional Thermal Current $I_{th}$ (A)	Contact Configuration	Rated Operational Current AC-15 $I_e$ (A)			Circuit Symbol	Screw Terminals	Spring Cage Terminals	Price	
		220 – 240V	380 – 415V	500V		catalogue Number ①	catalogue Number ①	AC Coil	DC Coil
10	4NO	6	3	1.5		XTRM10A40_	XTRMC10A40_		
10	3NO-1NC	6	3	1.5		XTRM10A31_	XTRMC10A31_		
10	2NO-2NC	6	3	1.5		XTRM10A22_	XTRMC10A22_		

① Underscore ( \_ ) indicates magnet coil suffix required. See Table B-5.

**Control Relays**



Table B-4. Control Relays

Conventional Thermal Current Open at 60°C $I_{th}$ (A)	Contact Configuration	Rated Operational Current AC-15 $I_e$ (A)			Circuit Symbol	Screw Terminals	Spring Cage Terminals	Price	
		220 – 240V	380 – 415V	500V		catalogue Number ②	catalogue Number ②	AC Coil	DC Coil
16	4NO	6	4	1.5		XTRE10B40_	XTREC10B40_		
16	3NO-1NC	6	4	1.5		XTRE10B31_	XTREC10B31_		
16	2NO-2NC	6	4	1.5		XTRE10B22_ ③	XTREC10B22_ ③		

② Underscore ( \_ ) indicates magnet coil suffix required. See Table B-5.

③ DC operated control relays XTRE(C)10B22\_ can only be combined with 2-pole auxiliary contacts.

Table B-5. Coil Voltage Suffix

Coil Voltage	Suffix Code
110V 50 Hz, 120V 60 Hz	<b>A</b>
220V 50 Hz, 240V 60 Hz	<b>B</b>
230V 50 Hz	<b>F</b>
24V 50/60 Hz	<b>T</b>
24V DC	<b>TD</b>
415V 50 Hz, 480V 60 Hz	<b>C</b>
550V 50 Hz, 600V 60 Hz	<b>D</b>

Coil Voltage	Suffix Code
208V 60 Hz	<b>E</b>
190V 50 Hz, 220V 60 Hz	<b>G</b>
240V 50 Hz, 277V 60 Hz	<b>H</b>
380V 50 Hz, 440V 60 Hz	<b>L</b>
400V 50 Hz	<b>N</b>
380V 60 Hz	<b>P</b>
12V 50/60 Hz	<b>R</b>

Coil Voltage	Suffix Code
24V 50 Hz	<b>U</b>
42V 50 Hz, 48V 60 Hz	<b>W</b>
48V 50 Hz	<b>Y</b>
120V DC	<b>AD</b>
220V DC	<b>BD</b>
12V DC	<b>RD</b>
48V DC	<b>WD</b>

**Notes:**

- Orders must be placed in multiples of the package quantity listed.
- DC operated control relays have a built-in suppressor circuit.
- Contact terminal numbers to EN50011.
- Coil terminal numbers to EN50005.

Accessories ..... **Page B-5**  
 Dimensions ..... **Page B-13**  
 Discount Symbol ..... **MC7/MC8**

**Accessories**



**Auxiliary Contacts**

**Table B-6. Front Mount Auxiliary Contacts for Use with XTRM Mini Control Relays**

Conventional thermal current, I <sub>th</sub> Open (A)	Rated Operational Current AC-15 I <sub>e</sub> (A)			Contact Configuration	Contact Sequence	Package Qty.	Screw Terminals	Spring Cage Terminals	Price <sup>①</sup>
	220V 230V 240V	380V 400V 415V	500V				catalogue Number	catalogue Number	
10	4	2	1.5	2NC		5	XTMCXFA02	—	
10	4	2	1.5	1NO-1NC		5	XTMCXFA11	XTMCXFAC11	
10	4	2	1.5	2NO		5	XTMCXFA20	—	
10	4	2	1.5	1NO <sub>E</sub> -1NC <sub>L</sub>		5	XTMCXFAL11 <sup>②</sup>	—	
10	4	2	1.5	4NC		5	XTMCXFA04	XTMCXFAC04	
10	4	2	1.5	1NO-3NC		5	XTMCXFA13	XTMCXFAC13	
10	4	2	1.5	2NO-2NC		5	XTMCXFA22	XTMCXFAC22	
10	4	2	1.5	3NO-1NC		5	XTMCXFA31	XTMCXFAC31	
10	4	2	1.5	4NO		5	XTMCXFA40	XTMCXFAC40	
10	4	2	1.5	1NO-1NC 1NO <sub>E</sub> -1NC <sub>L</sub>		5	XTMCXFAL22 <sup>②</sup>	XTMCXFCLC22 <sup>②</sup>	














① Orders must be placed in multiples of package quantity listed.

② 1 early-make contact (NO<sub>E</sub>), 1 late-break contact (NC<sub>L</sub>).

**B**

Relays and Timers

Table B-7. Front Mount Auxiliary Contacts for Use with XTRE Control Relays ③

	Conventional Thermal Current, I <sub>th</sub> (A), Open at 60°C	Poles	Rated Operational Current AC-15 I <sub>e</sub> (A)			Contact Configuration	Circuit Symbol	Pkg. Qty.	Screw Terminals	Spring Cage Terminals	Price ①
			220V	380V	400V				240V	415V	
	16	2	6	3	1.5	2NO		5	XTCEXFAC20	XTCEXFACC20	
	16	2	6	3	1.5	1NO-1NC		5	XTCEXFAC11	XTCEXFACC11	
	16	2	6	3	1.5	2NC		5	XTCEXFAC02	XTCEXFACC02	
	16	2	6	3	1.5	1NO <sub>E</sub> -1NC <sub>L</sub>		5	XTCEXFALC11 ②	XTCEXFALCC11 ②	
	16	4	6	3	1.5	4NO		5	XTCEXFAC40	XTCEXFACC40	
	16	4	6	3	1.5	3NO-1NC		5	XTCEXFAC31	XTCEXFACC31	
	16	4	6	3	1.5	2NO-2NC		5	XTCEXFAC22	XTCEXFACC22	
	16	4	6	3	1.5	1NO-3NC		5	XTCEXFAC13	XTCEXFACC13	
	16	4	6	3	1.5	4NC		5	XTCEXFAC04	XTCEXFACC04	
	16	4	6	3	1.5	1NO-1NC 1NO <sub>E</sub> -1NC <sub>L</sub>		5	XTCEXFCLC22 ②	XTCEXFCLCC22 ②	
	16	4	6	3	1.5	1NO-1NC 1NO <sub>E</sub> -1NC <sub>L</sub>		5	XTCEXFCLC22 ②	XTCEXFCLCC22 ②	

① Orders must be placed in multiples of package quantity listed.

② 1 early-make contact (NO<sub>E</sub>), 1 late-break contact (NC<sub>L</sub>).

③ Interlocked opposing contacts, to IEC/EN 60947-5-1 Annex L (positively driven), within the auxiliary contact modules (not NO<sub>E</sub> and NC<sub>L</sub> contacts) and between the auxiliary contacts and built-in contacts of the XTRE control relays.

Suppressors

For AC operated contactors 50 – 60 Hz. On DC operated contactor relays and on XTRE10B the suppressor circuit is built-in. Note drop-out relay.



Varistor Suppressor ④⑤



Table B-8. Varistor Suppressor for XTRE


Voltage	For Use with...	Pkg. Qty.	catalogue Number	Price ⑥
24 – 48	XTCE007B – XTCE015B,	10	XTCEXVSBW	
48 – 130	XTCF020B, XTRE(C)10B	10	XTCEXVSB A	
130 – 240		10	XTCEXVSB B	
240 – 500		10	XTCEXVSB C	

④ Note drop-out delay.

⑤ For AC operated contactors, 50/60 Hz. DC operated contactors have an integrated suppressor.

⑥ Orders must be placed in multiples of package quantity listed.

Table B-9. Varistor Suppressor for XTRM ⑦

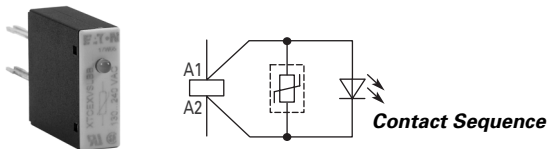
Voltage	For Use with...	Circuit Symbol	Package Qty.	catalogue Number	Price ⑧
24 – 48	XTRM6A..., XTRM9A...		10	XTMCXVSW	
48 – 130	XTRM6A..., XTRM9A...		10	XTMCXVSA	
110 – 250	XTRM6A..., XTRM9A...		10	XTMCXVSB	
380 – 415	XTRM6A..., XTRM9A...		10	XTMCXVSN	
24 – 48	XTRM6A..., XTRM9A...		10	XTMCXVSCW	
48 – 130	XTRM6A..., XTRM9A...		10	XTMCXVSCA	
110 – 250	XTRM6A..., XTRM9A...		10	XTMCXVSCB	

⑦ For AC operated contactors, 50/60 Hz. DC operated contactors have integrated varistor suppressors.

⑧ Orders must be placed in multiples of package quantity listed.

Discount Symbol ..... MC7/MC8

**Varistor Suppressor with Integrated LED** ①②



**Free-Wheel Diode Suppressor**



**Table B-10. Varistor Suppressor for XTRE**

Voltage	For Use with...	Pkg. Qty.	catalogue Number	Price ③
24 – 48	XTRE(C)10B	10	XTCEXVSLBW	
130 – 240		10	XTCEXVSLBB	

- ① Note drop-out delay.
- ② For AC operated contactors, 50/60 Hz. DC operated contactors have an integrated suppressor.
- ③ Orders must be placed in multiples of package quantity listed.

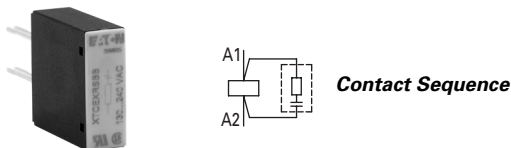
In addition to the built-in suppressor circuit for DC actuated contactors. Prevents negative breaking voltage when contactors are used in combination with a safety PLC.

**Table B-13. Free-Wheel Diode Suppressor for XTRE**

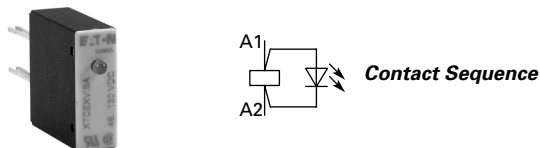
Voltage	For Use with...	Pkg. Qty.	catalogue Number	Price ④
12 – 250 DC	XTRE10B	10	XTCEXD5B	

- ④ Orders must be placed in multiples of package quantity listed.

**RC Suppressor** ⑤⑥



**Voltage Indicator**



**Table B-11. RC Suppressor for XTRE**

Voltage	For Use with...	Pkg. Qty.	catalogue Number	Price ⑥
24 – 48	XTRE(C)10B	10	XTCEXRSBW	
48 – 130		10	XTCEXRSBA	
110 – 240		10	XTCEXRSBB	
240 – 500		10	XTCEXRSBC	

- ④ Note drop-out delay.
- ⑤ For AC operated contactors, 50/60 Hz. DC operated contactors have an integrated suppressor.
- ⑥ Orders must be placed in multiples of package quantity listed.

**Table B-14. Voltage Indicator for XTRE**

Voltage	For Use with...	Pkg. Qty.	catalogue Number	Price ⑦
24 – 48	XTRE(C)10B	10	XTCEXVIBW	
110 – 120		10	XTCEXVIBA	
110 – 250		10	XTCEXVIBB	

- ⑦ Orders must be placed in multiples of package quantity listed.



**Table B-12. RC Suppressor for XTRM** ⑦

Voltage	For Use with...	Circuit Symbol	Package Qty.	catalogue Number	Price ⑧
24 – 48	XTRM6A..., XTRM9A...		10	XTMCXRSW	
48 – 130	XTRM6A..., XTRM9A...		10	XTMCXRSA	
110 – 250	XTRM6A..., XTRM9A...		10	XTMCXRSB	
24 – 48	XTRMC6A..., XTRMC9A...		10	XTMCXRSCW	
48 – 130	XTRMC6A..., XTRMC9A...		10	XTMCXRSCA	
110 – 250	XTRMC6A..., XTRMC9A...		10	XTMCXRSCB	

- ⑦ For AC operated contactors, 50/60 Hz. Note drop-out delay.
- ⑧ Orders must be placed in multiples of package quantity listed.



Discount Symbol ..... MC7/MC8

B

**Relays and Timers**

**Connector ①**



**Table B-15. Connector**

	For Use with...	Pkg. Qty.	catalogue Number	Price ②
	XTRE(C)10B	50	XTCEXCNC	
	XTRM10A	50	XTMCXCN	

- ① For mechanically arranging contactors in combinations. Distance between contactors is 0 mm.
- ② Orders must be placed in multiples of package quantity listed.

**Mechanical Interlock ③**

**Table B-16. Mechanical Interlock**

	For Use with...	Pkg. Qty.	catalogue Number	Price ④
	XTRE10B...	5	XTCEXMLB	
	XTRM10A...	5	XTMCXML	

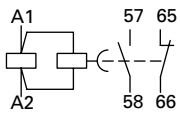
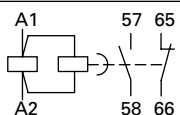
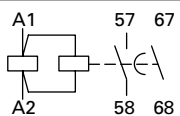

- ③ For two contactors with AC or DC operated magnet system which are horizontally or vertically mounted. For B frame, mechanical lifespan is 2.5 x 10<sup>6</sup> operations and the distance between contactors is 0 mm.
- ④ Orders must be placed in multiples of package quantity listed.

**Electronic Timer Modules**



Front (Top) mounted timer modules for use with XTRE10B control relays. Can not be combined with top mount auxiliary contacts, XTCEXF\_C\_.

**Table B-17. Electronic Timer Modules for XTRE**

Voltage	Contact Sequence	Timing Range	For Use with...	Pkg. Qty.	catalogue Number	Price ⑤
<b>On-Delayed</b>						
24V AC/DC		0.05 – 1 s 0.5 – 10 s 15 – 100 s	XTRE10B_	1	XTCEXTEEC11T	
100 – 130V AC					XTCEXTEEC11A	
200 – 240V AC					XTCEXTEEC11B	
<b>Off-Delayed</b>						
24V AC/DC		0.05 – 1 s	XTRE10B_	1	XTCEXTED1C11T	
100 – 130V AC					XTCEXTED1C11A	
200 – 240V AC					XTCEXTED1C11B	
24V AC/DC		0.5 – 10 s	XTRE10B_	1	XTCEXTED10C11T	
100 – 130V AC					XTCEXTED10C11A	
200 – 240V AC					XTCEXTED10C11B	
24V AC/DC		5 – 100 s	XTRE10B_	1	XTCEXTED100C11T	
100 – 130V AC					XTCEXTED100C11A	
200 – 240V AC					XTCEXTED100C11B	
<b>Star-Delta</b>						
24V AC/DC		1 – 30 s	XTRE10B_	1	XTCEXTEYC20T	
100 – 130V AC					XTCEXTEYC20A	
200 – 240V AC					XTCEXTEYC20B	
<b>Sealable Shroud</b>						
	Transparent sealable shroud used to protect electronic timer modules from unwanted access.		XTCEXTEE, XTCEXTED, XTCEXTEY	1	XTCEXTESHRD	

- ⑤ Orders must be placed in multiples of package quantity listed.

Discount Symbol ..... **MC8/MC7**

Mini Electronic Timers



Table B-18. Mini Electronic On-Delay Timers

Conventional Thermal Current I <sub>e</sub> (A)	Rated Operational Current I <sub>e</sub> AC-11 Amps		Time Range	Function	Terminal Marking According to EN 50042	catalogueue Number	Price
	220/230/240V	380/400/440V					
6	3	3	1.5 – 30 sec 0.05 – 1 sec 0.15 – 3 sec 0.5 – 10 sec 3 – 60 sec	Fixed, On-delay		XTMT6A30S11B	
6	3	6	0.15 – 3 min 0.5 – 10 min 3 – 60 min 0.15 – 3 h 0.5 – 10 h 3 – 60 h	Fixed, On-delay		XTMT6A60H11B	
6	3	3	0.05 – 1 sec 0.15 – 3 sec 0.5 – 10 sec 3 – 60 sec 0.15 – 3 min 0.5 – 10 min 3 – 60 min 0.15 – 3 h 0.5 – 10 h 3 – 60 h	Adjustable: On-delayed; Fleeting contact on energization; Flashing; Pulse generating; ON-OFF		XTMT6A60H70B	

Notes —

Actuating Voltage

24 – 240 50/60 Hz  
24 – 240V DC

Admissible Cable Length

Cable unscreened, with cable cross-section 0.5 – 1.5 mm<sup>2</sup>  
Two-core cable  
Two-core cable in the same cable duct with the main cable, 50/60 Hz

Connection to

Y1/Y2, Z1/Z2  
M250  
M50

Electronic Star-Delta (Wye-Delta) Timers



Table B-19. Electronic Star-Delta (Wye-Delta) Timers

Conventional Thermal Current I <sub>e</sub> (A)	Rated Operational Current I <sub>e</sub> AC-11 Amps		Time Range	Function	Terminal Marking According to EN 50042	catalogueue Number	Price
	230V	400V					
6	3	3	3 – 60 sec	Fixed, Star-Delta		XTTR6A60S51B	

Notes —

Actuating Voltage

24 – 240 50/60 Hz  
24 – 240V DC

Admissible Cable Length

Cable unscreened, with cable cross-section 0.5 – 1.5 mm<sup>2</sup>  
Two-core cable  
Two-core cable in the same cable duct with the main cable, 50/60 Hz

Connection to

B1, Z1/Z2  
M250  
M50

Discount Symbol ..... MC7/MC8

B



## Relays and Timers

## Technical Data and Specifications

Table B-20. Relays and Timers — Technical Data and Specifications

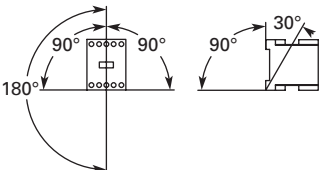
Description	XTRE	XTCEXFAC_	XTCEXTE_	XTRM	XTMCXF_
<b>General</b>					
Standards	IEC/EN 60947, VDE 0660, UL, CSA		DIN EN 61812, IEC/EN 60947, VDE 060, UL, CSA	IEC/EN 60947, VDE 0660, UL, CSA	
Lifespan, Mechanical					
AC Operated	20,000,000	10,000,000	3,000,000	10,000,000	10,000,000
DC Operated	20,000,000	10,000,000	3,000,000	20,000,000	20,000,000
Maximum operating frequency (ops/hr)	9000	9000	—	9000	9000
Climatic Proofing	Damp heat, constant, to IEC 60068-2-78; Damp heat, cyclical, to IEC 60068-2-30				
Ambient Temperature					
Open (°C, min/max)	-25/60	-25/60	-40/80	-25/50	-25/50
Enclosed (°C, min/max)	-25/40	-25/40	-25 – 60	-25/40	-25/40
Ambient Temperature for Storage (°C, min/max)	-40/80	-40/80	-25 – 40	—	—
Mounting Position			As required, not suspended	As required, except vertically A1/A2 at the bottom	
Mechanical shock resistance (IEC/EN 60068-2-27)					
Half-sinusoidal shock 10 ms					
Base unit with auxiliary contact module					
Make contact	7g	7g	6g	10g	10g
Break contact	5g	5g	6g	8g	8g
Degree of Protection	IP20	IP20	IP20	IP20	IP20
Protection against direct contact from the front when actuated by a perpendicular test finger (IEC 536)	Finger- and back-of-hand proof				
Weight					
AC operated (kg)	0.23	0.05	0.08	0.17	—
DC operated (kg)	0.28	0.05	0.08	0.20	—
Terminal capacity					
Screw terminals					
Solid (mm <sup>2</sup> )		1 x (0.75 – 4) 2 x (0.75 – 2.5)	1 x (0.75 – 2.5) 2 x (0.75 – 1.5)		1 x (0.75 – 2.5) 2 x (0.75 – 2.5)
Flexible with ferrule (mm <sup>2</sup> )		1 x (0.75 – 2.5) 2 x (0.75 – 2.5)	1 x (0.75 – 1.5) 2 x (0.75 – 1.5)		1 x (0.75 – 1.5) 2 x (0.75 – 1.5)
Solid or stranded (AWG)		18 – 14	18 – 14		18 – 14
Terminal screw	M3.5	M3.5	M3.5	M3.5	M3.5
Pozidriv screwdriver	Size 2	Size 2	Size 2	Size 2	Size 2
Standard screwdriver (mm)		0.8 x 5.5 1 x 6	0.8 x 5.5 1 x 6		0.8 x 5.5 1 x 6
Max. tightening torque (Nm)	1.2	1.2	1.2	1.2	1.2
Spring cage terminals					
Solid (mm <sup>2</sup> )		1 x (0.75 – 2.5) 2 x (0.75 – 2.5)	—		1 x (0.75 – 2.5) 2 x (0.75 – 2.5)
Flexible with or without ferrule DIN 46228 (mm <sup>2</sup> )		1 x (0.75 – 2.5) 2 x (0.75 – 2.5)	—		1 x (0.75 – 2.5) 2 x (0.75 – 2.5)
Solid or stranded (AWG)		18 – 14	—		18 – 14
Standard screwdriver (mm)		0.6 x 3.5	—		0.6 x 3.5
<b>Contacts</b>					
Interlocked opposing contacts to ZH 1/457, including auxiliary contact module	Yes	Yes	No	Yes	Yes
Rated impulse withstand voltage (U <sub>imp</sub> ) V AC	6000	6000	6000	6000	6000
Overvoltage category/pollution degree	III/3	III/3	III/3	III/3	III/3
Rated insulation voltage (U <sub>i</sub> ) V AC	690	690	600	690	690
Rated operational voltage (U <sub>e</sub> ) V AC	690	500	400	600	600
Safe isolation to VDE 0106 Part 101 and Part 101/A1					
Between coil and auxiliary contacts (V AC)	400	400	250	300	300
Between the auxiliary contacts (V AC)	400	400	250	300	300
Rated operational current					
AC-15 220/240V I <sub>e</sub>	6	6	Please inquire	6	4
380/415V I <sub>e</sub>	4	3	Please inquire	3	2
500V I <sub>e</sub>	1.5	—	—	1.5	1.5

Table B-20. Relays and Timers — Technical Data and Specifications (Continued)

Description	XTRE	XTCEXFAC_	XTCEXTE_	XTRM	XTMCXFA_
<b>Contacts (Continued)</b>					
DC-13 ①					
DC13 L/R ≤ 15 mS					
Contacts in series: Voltage:					
1 24V	10	10	—	2.5	2.5
1 60V	6	6	—	—	—
2 60V	10	10	—	2.5	2.5
1 110V	3	3	—	—	—
3 110V	6	6	—	1.5	1.5
1 220V	1	1	—	—	—
3 220V	5	5	—	0.5	0.5
DC-13 L/R ≤ 50 mS					
Contacts in series: Voltage:					
3 24V	4	—	—	—	—
3 60V	4	—	—	—	—
3 110V	2	—	—	—	—
3 220V	1	—	—	—	—
Control circuit reliability (at $U_e = 24V$ DC, $U_{min} = 17$ , $I_{min} = 5.4$ mA)	Failure rate = $<10^{-8}$ , < one failure in 100 million operations		—	Failure rate = $<10^{-8}$ , < one failure in 100 million operations	
Conventional thermal current ( $I_{th}$ )	16	16	6	10	10
Short-circuit rating without welding Maximum overcurrent protective device					
220/240V – XTPR Frame B	4	—	—	4	4
380/415V – XTPR Frame B	4	—	—	4	4
Short-circuit protection, max. fuse					
500V (A gG/gL)	10	10	6	6	6
500V (A fast)	—	—	—	10	10
Current heat losses at load of $I_{th}$					
AC operated (W)	0.3	0.3	—	0.2	0.2
DC operated (W)	0.3	0.3	—	0.3	0.3
<b>Magnet Systems</b>					
Pick-up and drop-out values					
AC operated					
Single-voltage coil 50 Hz and dual-voltage coil 50 Hz, 60 Hz (Pick-up x $U_c$ )	0.8 – 1.1	—	0.85 – 1.1	0.8 – 1.1	—
Dual-frequency coil 50/60 Hz (Pick-up x $U_c$ )	0.8 – 1.1	—	—	0.85 – 1.1	—
DC operated ②					
Pick-up voltage (Pick-up x $U_c$ )	0.8 – 1.1	—	0.7 – 1.2	0.85 – 1.3	—
At 24V: without auxiliary contact module (40°C) (Pick-up x $U_c$ )	0.7 – 1.3	—	—	0.7 – 1.3	—
Power consumption					
Single-voltage coil 50 Hz and dual-voltage coil 50 Hz, 60 Hz					
Pick-up VA	24	—	—	25	—
Pick-up W	19	—	—	22	—
Sealing VA	3.4	—	2	4.6	—
Sealing W	1.2	—	1.8	1.3	—
Dual-frequency coil 50/60 Hz at 50 Hz					
Pick-up VA	27	—	—	30	—
Pick-up W	22	—	—	26	—
Sealing VA	4.2	—	—	5.4	—
Sealing W	1.4	—	—	1.6	—
Dual-frequency coil 50/60 Hz at 60 Hz					
Pick-up VA	25	—	—	29	—
Pick-up W	21	—	—	24	—
Sealing VA	3.3	—	—	3.9	—
Sealing W	1.2	—	—	1.2	—
DC operated					
Pull-in = sealing (W)	3	—	—	2.6	—
Duty factor (% DF)	100	—	100	100	—
Switching times at 100% $U_c$ (approximate values)					
AC operated closing delay (mS)	≤21	—	—	14 – 21	—
AC operated NO contact opening delay (mS)	≤18	—	—	8 – 18	—
AC operated with auxiliary contact module, max. closing delay (mS)	—	—	—	45	45
DC operated closing delay (mS)	≤31	—	—	26 – 35	—
DC operated NO contact opening delay (mS)	≤12	—	—	15 – 25	—
DC operated with auxiliary contact module, max. closing delay (mS)	—	—	—	70	70

① Making and breaking conditions to DC13, time constant as stated.

② Smoothed DC or three-phase bridge rectifier.

Relays and Timers

Control Relays

B

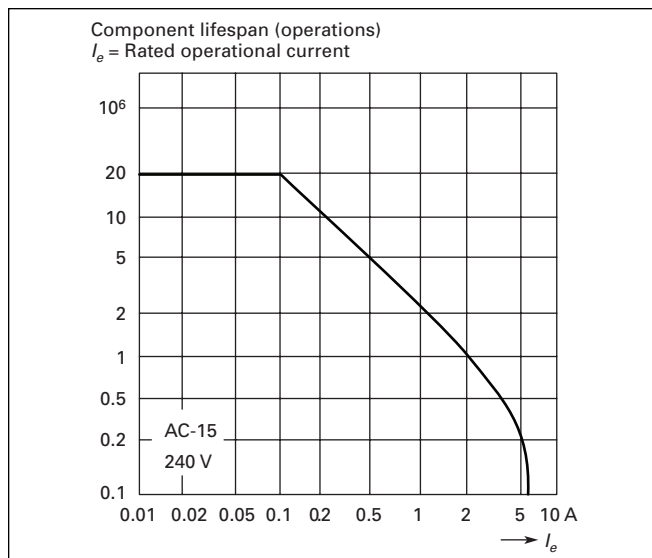


Figure B-1. XTRE (AC-15) Characteristic Curve

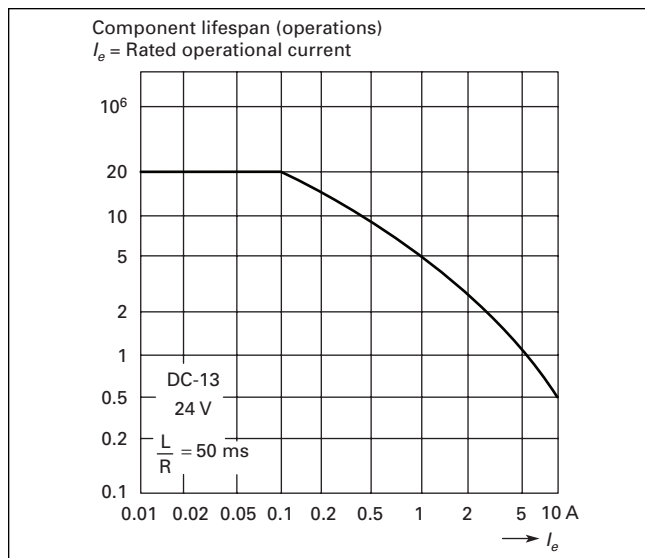


Figure B-2. XTRE (DC-13) Characteristic Curve ①

① Making and breaking conditions to DC-13, time constant as stated.

The diagrams show the closing and opening travel of the contact of the contactor relays and auxilliary contacts at no load. Tolerances are not taken into consideration.

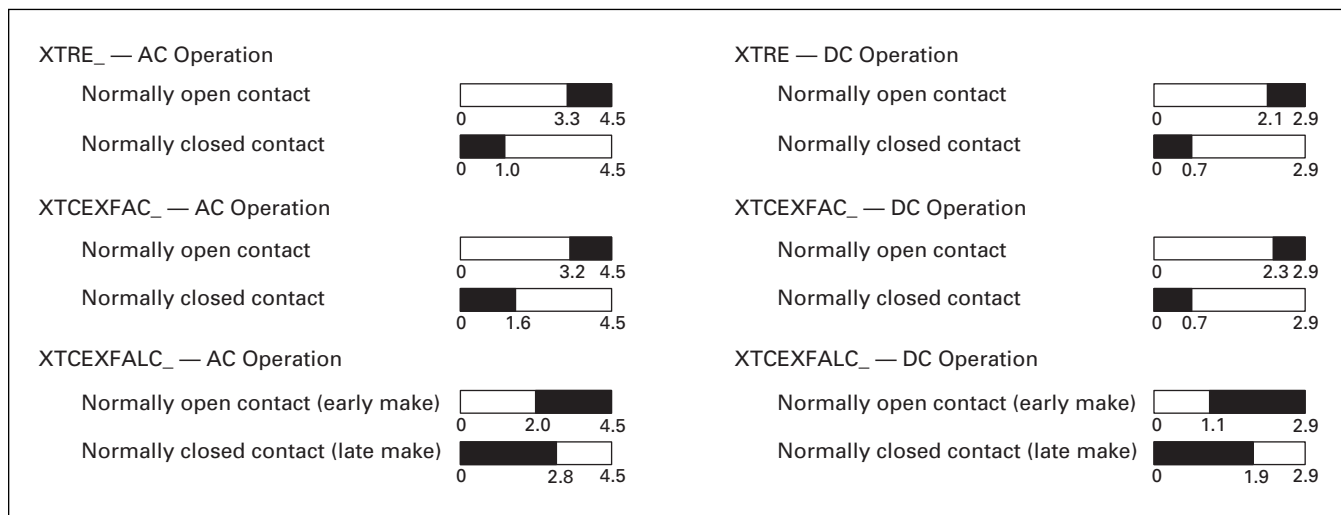
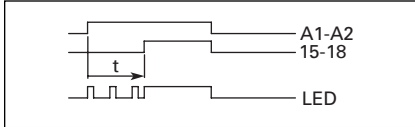


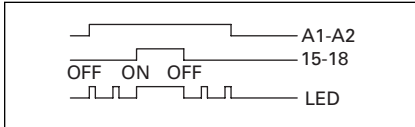
Figure B-3. Contact Travel Diagrams — XTRE

**Flow Diagrams — Electronic Timers**

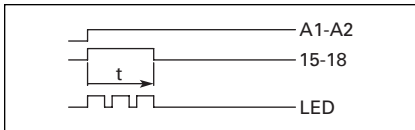
**XTMT Mini Timers**



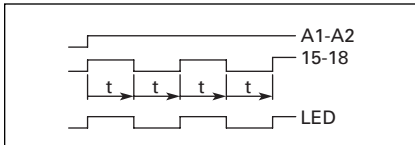
**Figure B-4. On-Delayed**



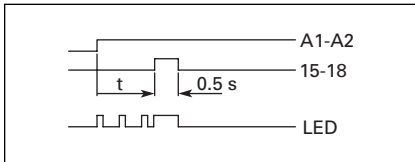
**Figure B-5. ON-OFF Function**



**Figure B-6. Fleeting Contact on Energization**

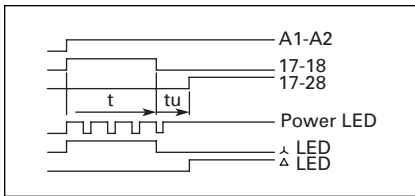


**Figure B-7. Flashing, Pulse Initiating**



**Figure B-8. Pulse Generating**

**Star-Delta (Wye-Delta) Timer**



**Figure B-9. Star-Delta**

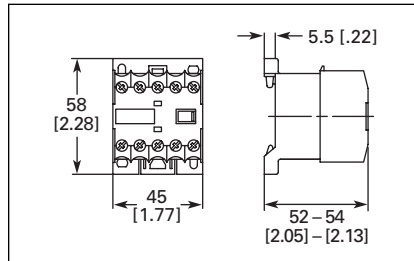
**Rating Data**

**Table B-21. Rating Data for Approved Types**

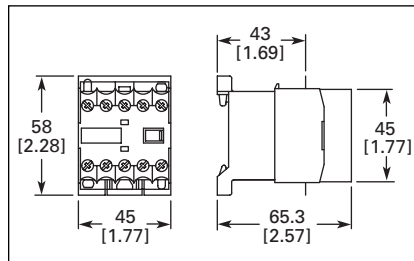
Pilot Duty	General Use
<b>Control Relays — XTMR</b>	
A600, P300	10A – 600V AC 0.5A – 250V DC
<b>Timers — XTMT, XTTR</b>	
B300	6A – 250V AC

**Dimensions**

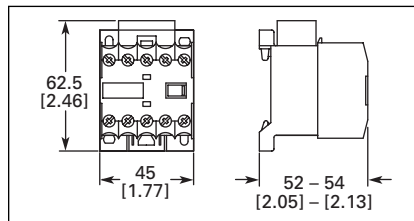
**Mini Control Relays**



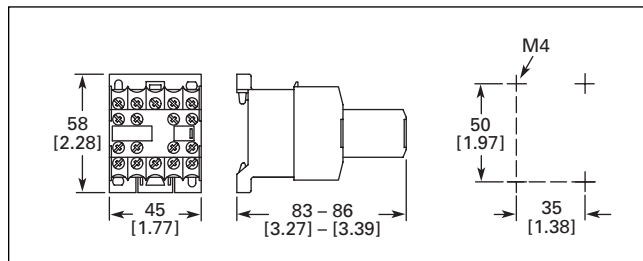
**Figure B-10. Mini Control Relay XTRM — Approximate Dimensions in mm [in.]**



**Figure B-11. XTRM Mini Control Relay with IP40 XTMCX Shroud — Approximate Dimensions in mm [in.]**



**Figure B-12. XTRM Mini Control Relay with RC or Varistor Suppressor — Approximate Dimensions in mm [in.]**



**Figure B-13. XTRM Mini Control Relay with XTMCXFA Auxiliary Contact — Approximate Dimensions in mm [in.]**

**B**

Control Relays

B

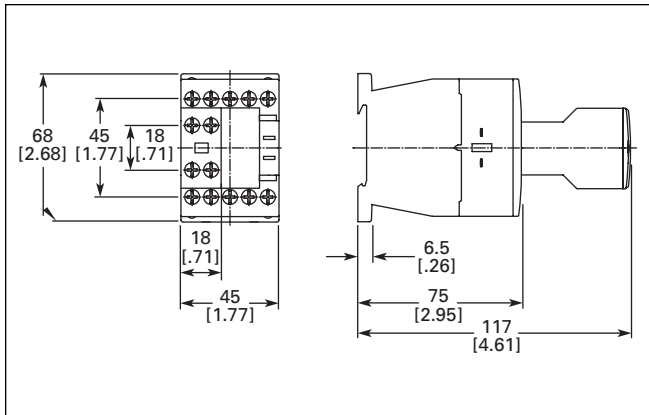


Figure B-14. Control Relay XTRE with XTCEXFA Auxiliary Contact — Approximate Dimensions in Inches (mm)

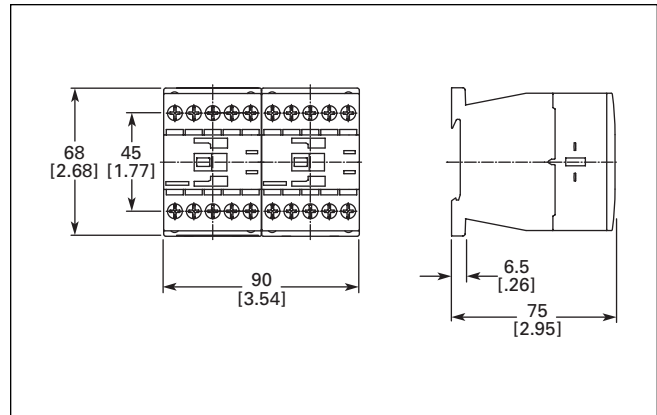


Figure B-17. Control Relays XTRE with XTCEXMLB Mechanical Interlock — Approximate Dimensions in Inches (mm)

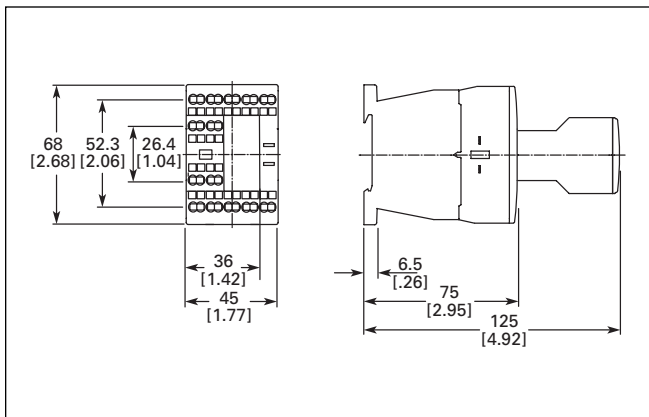


Figure B-15. Control Relay with Spring Cage Terminals XTREC with XTCEXFA Auxiliary Contact — Approximate Dimensions in Inches (mm)

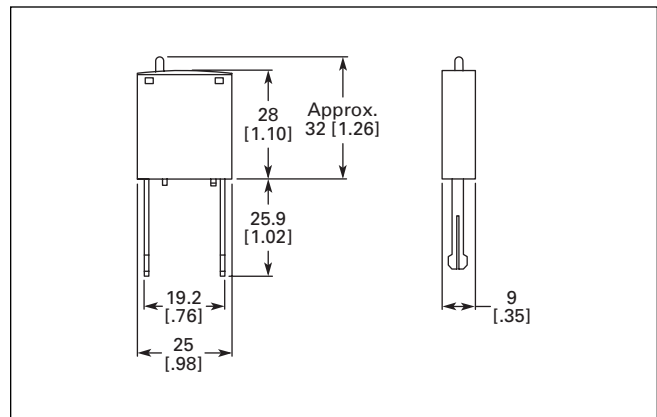


Figure B-18. Coil Suppressors for Use with XTRE Control Relays — Approximate Dimensions in Inches (mm)

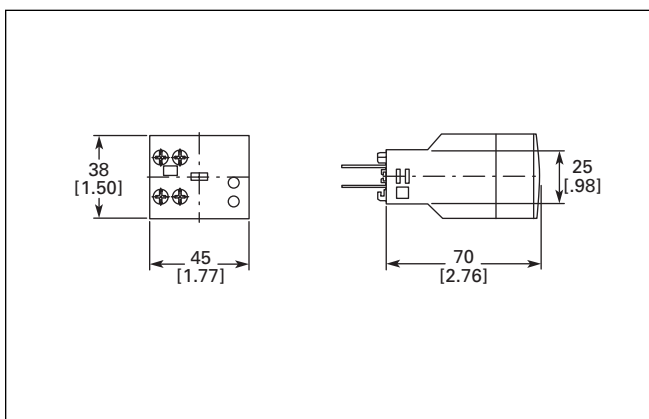


Figure B-16. Electronic Timer Module XTCEXTE — Approximate Dimensions in Inches (mm)