

DA Series Miniature Single Pole Rocker Switches

Features/Benefits

- Nice actuator styling with multiple options
- Guards to prevent accidental actuation
- Momentary and maintained functions
- IP65 splash proof rubber boot option
- RoHS compliant



Typical Applications

- Small appliances
- Computers and peripherals
- Medical instrumentation



Specifications

CONTACT RATING:

UL/CSA: 16 AMPS @ 125 VAC, 1/3 HP;

10 AMPS @ 250 VAC, 1/2 HP.

VDE: 10 AMPS @ 125 VAC, 6 AMPS @ 250 VAC.

ELECTRICAL LIFE: 10,000 make and break cycles at full load.

INSULATION RESISTANCE: $10^8 \Omega$ min.

DIELECTRIC STRENGTH: 1,500 VRMS @ sea level.

OPERATING TEMPERATURE: -20°C to +85°C

Materials

HOUSING AND ACTUATOR: 6/6 nylon (UL94V-2), black, matte finish.

ILLUMINATED ACTUATOR: Polycarbonate, matte finish.

CENTER CONTACTS: Silver plated, copper alloy.

END CONTACTS: Silver plated $AgSnO_2InO_3$.

ALL TERMINALS: Silver plated, copper alloy.

NOTE: Specifications and materials listed above are for switches with standard options. For information on specific and custom switches, consult Customer Service Center.

Build-A-Switch

To order, simply select desired option from each category and place in the appropriate box. Available options are shown and described on pages H-58 through H-60. For additional options not shown in catalog, consult Customer Service Center.

<div style="display: flex; justify-content: space-around; border-bottom: 1px solid black; margin-bottom: 10px;"> <div style="width: 15%;"></div> <div style="width: 15%;"></div> <div style="width: 15%;"></div> <div style="width: 15%;"></div> <div style="width: 15%;"></div> <div style="width: 15%;"></div> <div style="width: 15%;"></div> <div style="width: 15%;"></div> </div>		
<p>Switch Function</p> <p>DA101 SPDT On-None-On DA102 SPST On-None-Off DA103 SPDT On-Off-On DA12* SPST On-None-Off</p>	<p>Actuator</p> <p>J1 Rocker J2 Two-tone rocker J3 Illuminated rocker J4 Circle, illuminated rocker J5 Oval, illuminated rocker</p> <p>Actuator Color</p> <p>1-5 See Chart on Page H-59 R Red, illuminated A Amber, illuminated G Green, illuminated</p>	<p>Mounting Style/Color</p> <p>S2 Snap-in, black S1 Snap-in, white B2 Recessed snap-in bracket, black G2 Guard, black</p> <p>Termination</p> <p>15 .187" quick connect 17 Solder lug 02 Thru-hole A Right angle</p> <p>Actuator Marking</p> <p>(NONE) No marking D ON-OFF H "O I" - international ON-OFF N Large dot P "O -" international ON-OFF</p>
		<p>Contact Rating</p> <p>QF Silver</p>
		<p>Lamp Rating</p> <p>(NONE) No lamp 6 LED 7 125 VAC neon 8 250 VAC neon</p>

* DA12 — for switches with both marking and illumination



Dimensions are shown: Inch (mm)
Specifications and dimensions subject to change

Rocker



DA Series Miniature Single Pole Rocker Switches

SWITCH FUNCTION

NO. POLES	MODEL NO.	SWITCH FUNCTION			CONNECTED TERMINALS			SCHEMATIC
SP	DA101	ON	NONE	ON	2-3	N/A	2-1	
	DA102	ON	NONE	OFF				
	DA103	ON	OFF	ON				
	DA12 *	ON	NONE	OFF				

* DA12 - for switches with both marking and illumination

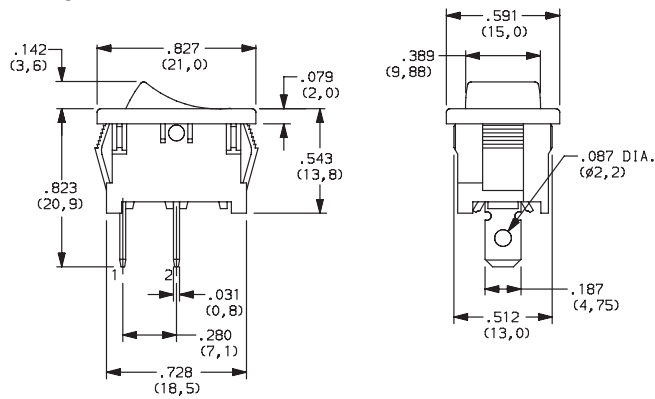

Shown in Pos. 1

ACTUATOR

J1 ROCKER

J3 ILLUMINATED ROCKER

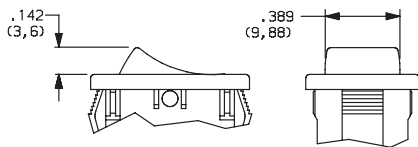

NOTE: J3 actuator available with DA102 & DA12 switch functions, 7&8 lamp ratings and not available with O2 and A termination options.

J2 TWO-TONE ROCKER

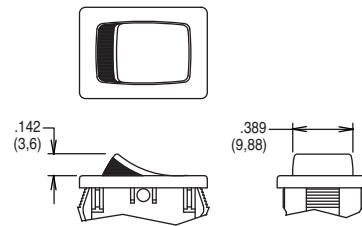

NOTE:

1. Available with DA102 switch function only.
2. Available with None or P actuator marking options only.

Rocker



C&K

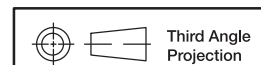

Third Angle
Projection

Dimensions are shown: Inch (mm)
Specifications and dimensions subject to change

DA Series Miniature Single Pole Rocker Switches

ACTUATOR

J4 CIRCLE, ILLUMINATED ROCKER

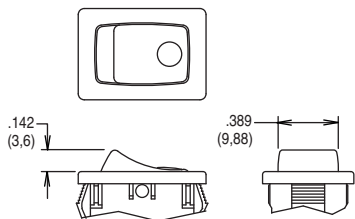

NOTE: Available with DA102 switch function and 7 & 8 lamp ratings combinations only. Not available with O2 and A termination options.

J5 OVAL, ILLUMINATED ROCKER

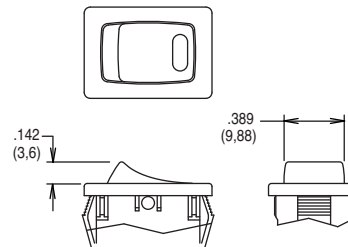

NOTE: Available with DA102 switch function and 6 lamp rating combinations only. Not available with O2 and A termination options.

ACTUATOR COLOR

	OPTION CODE	ACTUATOR COLOR
For J1 only	2	BLACK
	1	WHITE
	3	RED
For J3, J4, J5 only	R	RED, ILLUMINATED
	A	AMBER, ILLUMINATED
	G	GREEN, ILLUMINATED

OPTION CODE	ACTUATOR COLOR	
	TOP	BOTTOM
1	WHITE	RED
2	WHITE	BLACK
3	RED	WHITE
4	BLACK	WHITE
5	BLACK	RED

J2 actuator only

MOUNTING STYLE/COLOR

S2 SNAP-IN, BLACK

S1 SNAP-IN, WHITE

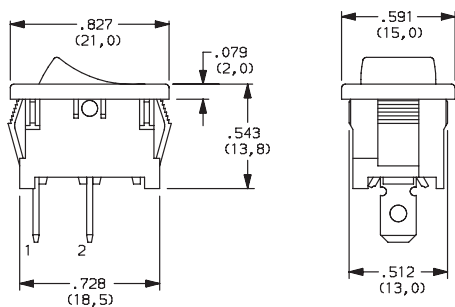

Actuator shown in Pos. 1

G2 GUARD, BLACK

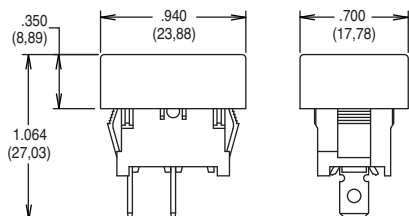

NOTE: Available with DA10X switch functions only.

B2 RECESSED SNAP-IN BRACKET, BLACK

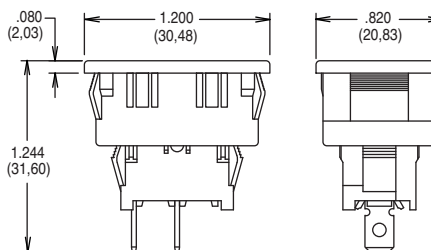

NOTE: Available with DA10X switch functions only.

S2, S1 & G2 PANEL MOUNTING

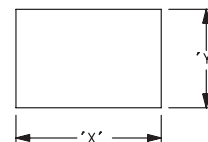

PANEL THICKNESS	"X"	"Y"
0.030-0.049 (0,75-1,25)	0.756-.004 (19,2-0,1)	0.512+.004 (13,0+0,1)
0.049-0.079 (1,25-2,0)	0.764-.004 (19,4-0,1)	0.512+.004 (13,0+0,1)
0.079-0.118 (2,0-3,0)	0.779-.004 (19,8-0,1)	0.512+.004 (13,0+0,1)

B2 PANEL MOUNTING

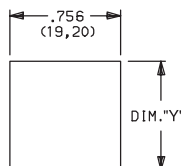

PANEL THICKNESS	"Y"
0.030-0.049 (0,75-0,25)	1.068 (27,13)
0.049-0.079 (1,25-2,0)	1.076 (27,33)
0.079-0.118 (2,0-3,0)	1.092 (27,74)

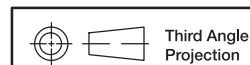

Dimensions are shown: Inch (mm)
Specifications and dimensions subject to change

C&K

Rocker



DA Series Miniature Single Pole Rocker Switches

TERMINATION

15 .187" QUICK CONNECT

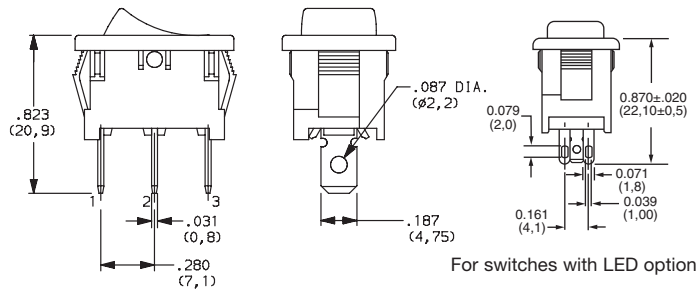

17 SOLDER LUG

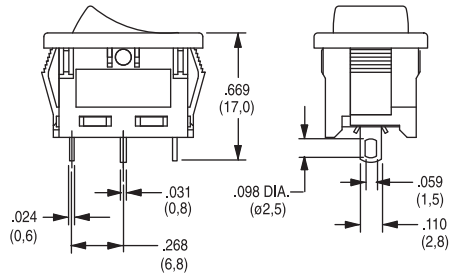

02* THRU-HOLE

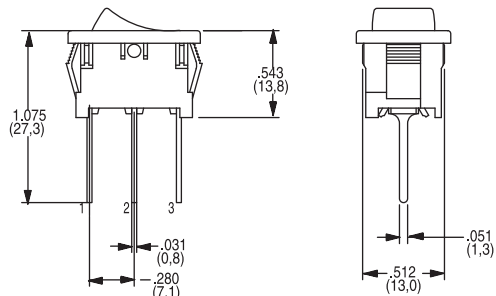

A* RIGHT ANGLE

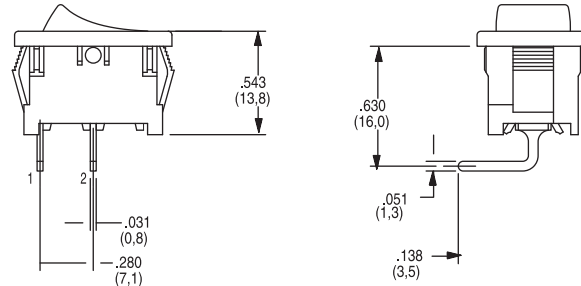

* NOTE - O2 and A termination options not offered with J3, J4 or J5 actuator options.

ACTUATOR MARKING

NONE NO MARKING



D ON-OFF

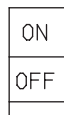

H O I

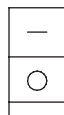

N LARGE DOT

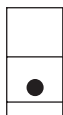

P O -

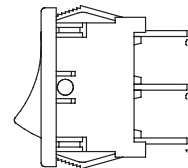
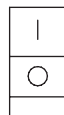

All models shown in Pos. 1

NOTE: Orientation of actuator marking and terminals.

CONTACT MATERIAL

OPTION CODE	CONTACT AND TERMINAL MATERIAL	RATINGS	
QF	SILVER	POWER	16 AMPS @ 125 VAC; 1/3 HP; 10 AMPS @ 250 VAC; 1/2 (UL/CSA). 10 AMPS @ 125 VAC, 6 AMPS @ 250 VAC (VDE)

* Note: See Technical Data section of this catalog for RoHS compliant and compatible definitions and specifications.

LAMP RATING

(NONE) NO LAMP

6 LED RATING @ 10 mA $V_f=1.85V$

7 125 VAC 33kΩ NEON

8 250 VAC 150kΩ NEON

ACCESSORIES

216C0000 IP65 SPLASH PROOF RUBBER BOOT

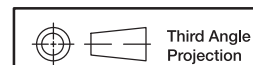
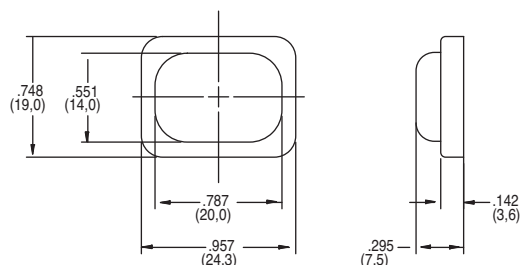

Third Angle Projection

Dimensions are shown: Inch (mm)
Specifications and dimensions subject to change

Rocker



C&K