

## Interactive Catalog Supplements Catalog PDFs

If you need detailed product information, or help choosing the right product for your application, see our [Interactive Catalog](#). Use the [Interactive Catalog](#) to access the most complete and up-to-date information available.

The [Interactive Catalog](#) provides an extensive collection of product specifications, application data, and technical literature that can be searched based on criteria you select.

This PDF catalog information was published in November 2000.



Sensing and Control  
[Interactive Catalog...](#)

**Click this icon to try  
the Interactive Catalog.**

---

**Sensing and Control**  
Honeywell Inc.  
11 West Spring Street  
Freeport, IL 61032

[www.honeywell.com/sensing](http://www.honeywell.com/sensing)

# Manual Switches

## Miniature Toggle Switches



1TW Standard unsealed toggle lever  
1/4" bushing



2TW101 Standard sealed toggle lever  
1/4" bushing



11TW Standard toggle lever  
15/32" bushing

12TW Pull-to-unlock toggle lever  
15/32" bushing

- Qualified to MIL-S-83781
- Save space and weight
- SPDT and DPDT circuitry
- Choice of 1/4" or 15/32" bushings
- 15/32" bushing has lever seal
- Pull-to-unlock option on 15/32" bushing

- UL Recognized
- Temperature range: -85°F to +160°F (-65°C to +71°C)
- Sealed bushing versions

Molded-in terminals are plated for soldering. There is positive return on momentary versions. All switches come with a lockwasher, a keying washer, and two hexnuts. Special "on-on-on" circuitries, similar to those shown for TL, are also available for TW.

### ELECTRICAL RATING

Volts	Amperes		
	Resistive	Inductive	Lamp
30 VDC	5	2	1
115 VAC	5	2	1
UL Code 117	5 amps @ 125 VAC		

### CIRCUITRY

1<sup>1</sup> Single Pole Double Throw



2<sup>1</sup> Two Single Pole Double Throw Circuits

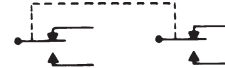

<sup>1</sup>Refer to order guides.

### TERMINAL CIRCUIT IDENTIFICATIONS

Terminal identifications are referred to in the Ordering Charts to indicate which circuits are made in each toggle position

(i.e., "1-2" reference indicates circuit closure through terminals 1 and 2).

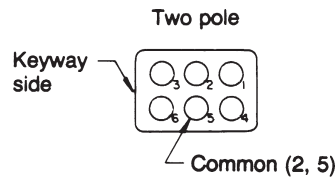
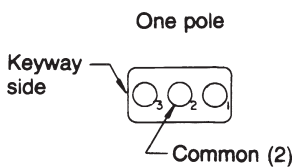

# Manual Switches

## Miniature Toggle Switches

### 2-POSITION ORDER GUIDES

#### Switches with 15/32" Bushings

No. Poles	Circuits Made with Toggle at:		Sealed Standard Toggle		Sealed Pull-to-Unlock Toggle**	
	Keyway Position	Opposite Keyway	Catalog Listing	Military No.	Add Suffix (next page) to Listing	Military No.**
1	OFF	2-3 ON	11TW1-2	MS27718-22-1	D, F, G	MS27720-22-1
1	2-1 ON	2-3 ON	11TW1-3	MS27718-23-1	D, F, G	MS27720-23-1
1	2-1 ON*	2-3 ON	11TW1-8	MS27718-26-1	F	MS27720-26-1
2	OFF	2-3 & 5-6 ON	12TW1-2	MS27719-22-1	D, F, G	MS27721-22-1
2	2-1 & 5-4 ON	2-3 & 5-6 ON	12TW1-3	MS27719-23-1	D, F, G	MS27721-23-1
2	2-1 & 5-4 ON*	2-3 & 5-6 ON	12TW1-8	MS27719-26-1	F	MS27721-26-1

\* These positions are momentary. All others are maintained.

\*\* Also add appropriate suffix letter to the Military Number.

#### Switches with 1/4" Bushings

No. Poles	Circuits Made with Toggle at:		Unsealed Standard Toggle		Sealed Standard Toggle
	Keyway Position	Opposite Keyway	Catalog Listing	Military No.	Catalog Listing
1	OFF	2-3 ON	1TW1-2	MS27716-22-1	1TW101-2
1	2-1 ON	2-3 ON	1TW1-3	MS27716-23-1	1TW101-3
1	2-1 ON*	2-3 ON	1TW1-8	MS27716-26-1	1TW101-8
2	OFF	2-3 & 5-6 ON	2TW1-2	MS27717-22-1	2TW101-2
2	2-1 & 5-4 ON	2-3 & 5-6 ON	2TW1-3	MS27717-23-1	2TW101-3
2	2-1 & 5-4 ON*	2-3 & 5-6 ON	2TW1-8	MS27717-26-1	2TW101-8

\* These positions are momentary. All others are maintained.

### 3-POSITION ORDER GUIDES

#### Switches with 15/32" Bushings

No. Poles	Circuits Made with Toggle at:			Sealed Standard Toggle		Sealed Pull-to-Unlock Toggle	
	Keyway Position	Center Position	Opposite Keyway	Catalog Listing	Military No.	Add Suffix (next page) to Listing	Military No.**
1	2-1 ON	OFF	2-3 ON	11TW1-1	MS27718-21-1	ALL	MS27720-21-1
1	2-1 ON*	OFF	2-3 ON	11TW1-5	MS27718-31-1	E, F, K, L, M, N	MS27720-31-1
1	2-1 ON*	OFF	2-3 ON*	11TW1-7	MS27718-27-1	E, L, N	MS27720-27-1
2	2-1 & 5-4 ON	OFF	2-3 & 5-6 ON	12TW1-1	MS27719-21-1	ALL	MS27721-21-1
2	2-1 & 5-4 ON*	OFF	2-3 & 5-6 ON	12TW1-5	MS27719-31-1	E, F, K, L, M, N	MS27721-31-1
2	2-1 & 5-4 ON*	OFF	2-3 & 5-6 ON*	12TW1-7	MS27719-27-1	E, L, N	MS27721-27-1

\* These positions only are momentary. All others are maintained.

\*\* Also add appropriate suffix letter to the Military Number.

#### Switches with 1/4" Bushings

No. Poles	Circuits Made with Toggle at:			Unsealed Standard Toggle		Sealed Standard Toggle
	Keyway Position	Center Position	Opposite Keyway	Catalog	Military No.	Catalog Listing
1	2-1 ON	OFF	2-3 ON	1TW1-1	MS27716-21-1	1TW101-1
1	2-1 ON*	OFF	2-3 ON	1TW1-5	MS27716-31-1	1TW101-5
1	2-1 ON*	OFF	2-3 ON*	1TW1-7	MS27716-27-1	1TW101-7
2	2-1 & 5-4 ON	OFF	2-3 & 5-6 ON	2TW1-1	MS27717-21-1	2TW101-1
2	2-1 & 5-4 ON*	OFF	2-3 & 5-6 ON	2TW1-5	MS27717-31-1	2TW101-5
2	2-1 & 5-4 ON*	OFF	2-3 & 5-6 ON*	2TW1-7	MS27717-27-1	2TW101-7

\* These positions are momentary. All others are maintained.













Toggle/Rockers

# Manual Switches

## Miniature Toggle Switches

### LOCKING CONFIGURATION SUFFIX

When ordering pull-to-unlock toggle listings, add the suffix letter shown in this chart to the standard toggle catalog listing and the Military Approval number.

<b>A</b>  Locked In Three Positions	<b>B</b>  Locked In Center and Extreme Position (Keyway Side)	<b>D</b>  Locked Out Of Center Position	<b>E</b>  Locked In Center Position	<b>F</b>  Locked In Extreme Position (Opposite Keyway)	<b>G</b>  Locked In Extreme Position (Keyway Side)	<b>H</b>  Locked Out Of Center And Extreme Position (Keyway Side)
<b>J</b>  Locked Out Of Center And Extreme Position (Opposite Keyway)	<b>K</b>  Locked In Center And Extreme Position (Opposite Keyway)	<b>L</b>  Locked Out Of Extreme Position (Keyway Side)	<b>M</b>  Locked Out Of And Into Extreme Position (Opposite Keyway)	<b>N</b>  Locked Out Of Extreme Position (Opposite Keyway)	<b>P</b>  Locked Out Of And Into Extreme Position (Keyway Side)	



### WITH IWTS TERMINATION

- 15/32" bushing has lever seal
- One or two pole circuitry
- Accepts #20 wire using M39029/1-101 contact pins
- Connections resist shock, vibration, and high pulling force

### 2 - POSITION ORDER GUIDE — IWTS TERMINATION

No. Poles	Circuits Made with Toggle at:		Standard Toggle	Pull-to-Unlock Toggle
	Keyway Position	Opposite Keyway	Catalog Listing	Add Suffix to Standard Listing
1 1	2-1 ON 2-1 ON*	2-3 ON 2-3 ON	111TW1-3 111TW1-8	D, F, G F
2 2	2-1 & 5-4 ON 2-1 & 5-4 ON*	2-3 & 5-6 ON 2-3 & 5-6 ON	112TW1-3 112TW1-8	D, F, G F

### 3 - POSITION ORDER GUIDE — IWTS TERMINATION

No. Poles	Circuits Made with Toggle at:			Standard Toggle	Pull-to-Unlock Toggle
	Keyway Position	Center Position	Opposite Keyway	Catalog Listing	Add Suffix to Standard Listing
1 1 1	2-1 ON 2-1 ON* 2-1 ON*	OFF OFF OFF	2-3 ON 2-3 ON 2-3 ON*	111TW1-1 111TW1-5 111TW1-7	ALL E, F, K, L, M, N E, L, N
2 2 2	2-1 & 5-4 ON 2-1 & 5-4 ON* 2-1 & 5-4 ON*	OFF OFF OFF	2-3 & 5-6 ON 2-3 & 5-6 ON 2-3 & 5-6 ON*	112TW1-1 112TW1-5 112TW1-7	ALL E, F, K, L, M, N E, L, N

\* These positions only are momentary. All others are maintained.

# Manual Switches

## Miniature Toggle Switches

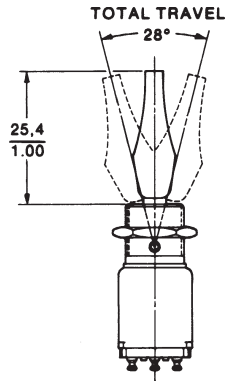

### WITH COLORED TAB LEVERS

- Available in seven colors
- Affords attractive front-of-panel appearance for graphic display and functional identify
- Levers made to withstand temperatures up to 160°F (71°C)
- Switches furnished with decorative knurled nut, a lockwasher, a keying washer, and a hex nut
- 15/32" bushing has lever seal
- Solder terminals (available with IWTS termination)

### ORDER GUIDE

To order, combine the basic (function) listing from Table 1 with the desired lever color suffix from Table 2. Colored tab levers are not available with 1/4 in. bushing.

TABLE 1 — TOGGLE POSITION AND CONTACT ARRANGEMENT

Positions	No. Poles	Circuits Made with Toggle at:			Basic Listing Add color suffix from Table 2.
		Keyway Position	Center Position	Opposite Keyway	
2	1	OFF	NONE	2-3 ON	11TW19-2 -
2	1	2-1 ON	NONE	2-3 ON	11TW19-3 -
2	1	2-1 ON*	NONE	2-3 ON	11TW19-8 -
2	2	OFF	NONE	2-3 & 5-6 ON	12TW19-2 -
2	2	2-1 & 5-4	NONE	2-3 & 5-6 ON	12TW19-3 -
2	2	2-1 & 5-4*	NONE	2-3 & 5-6 ON	12TW19-8 -
3	1	2-1 ON	OFF	2-3 ON	11TW19-1 -
3	1	2-1 ON*	OFF	2-3 ON	11TW19-5 -
3	1	2-1 ON*	OFF	2-3 ON*	11TW19-7 -
3	2	2-1 & 5-4 ON	OFF	2-3 & 5-6 ON	12TW19-1 -
3	2	2-1 & 5-4 ON*	OFF	2-3 & 5-6 ON	12TW19-5 -
3	2	2-1 & 5-4 ON*	OFF	2-3 & 5-6 ON*	12TW19-7 -

\* These positions only are momentary. All others are maintained.

TABLE 2 — TAB LEVER COLORS

Tab Lever Color	White	Black	Blue	Red	Green	Orange	Light Gray
Color suffix	A001	A002	A003	A004	A005	A006	A007

### TW SWITCHES WITH SPECIAL CIRCUITRIES

All 2-pole 3-position TW switches are available with special "on-on-on" -10, -50, -70 circuitry options as shown below.

2-Pole 3-Position Switches			Sealed Standard Toggle		Unsealed Std. Toggle	Sealed Tab Lever
Circuits Made With Toggle At:			15/32" bushing	1/4" bushing	1/4" bushing	15/32" bushing
Keyway Position	Center Position	Opposite Keyway	Catalog Listing	Catalog Listing	Catalog Listing	Catalog Listing Add color suffix from Table 2
2-1 & 5-4 ON	2-1 & 5-6 ON	2-3 & 5-6 ON	12TW1-10	2TW101-10	2TW1-10	12TW19-10 -
2-1 & 5-4 ON*	2-1 & 5-6 ON	2-3 & 5-6 ON	12TW1-50	2TW101-50	2TW1-50	12TW19-50 -
2-1 & 5-4 ON*	2-1 & 5-6 ON	2-3 & 5-6 ON*	12TW1-70	2TW101-70	2TW1-70	12TW19-70 -

\* These positions are momentary. All others are maintained.

Toggle/Rockers

# Manual Switches

## Miniature Toggle Switches

TW Series

### MOUNTING DIMENSIONS (For reference only)

#### Mounting detail for 1/4" bushing switches

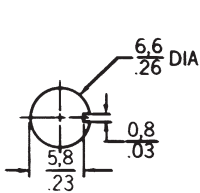

Without locking ring

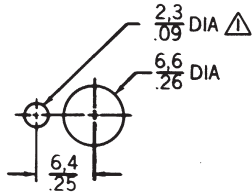

With locking ring

#### Mounting detail for 15/32" bushing switches

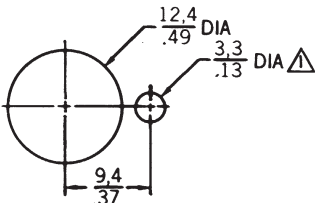

With locking ring

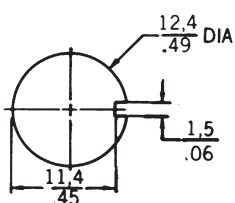

Without locking ring

#### Dimensions for 15/32" switches

##### Standard toggle lever

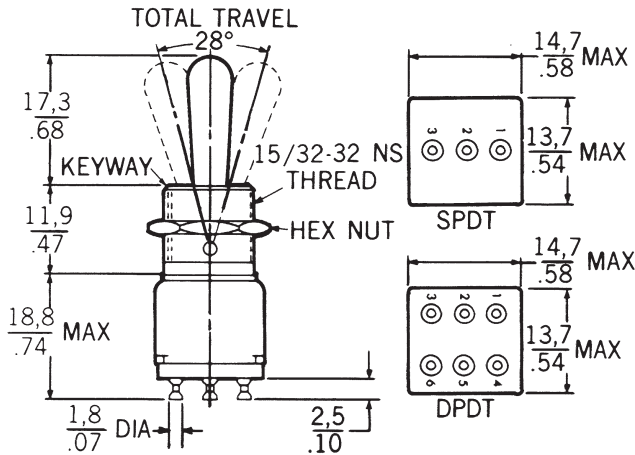

#### Dimensions for 1/4" bushing switches

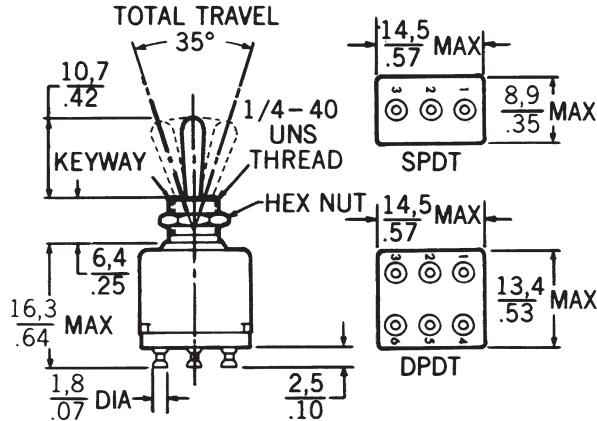

Note:  $\Delta$  1,1/.05 MIN. DEEP TO ACCOMMODATE LOCKING RING.  
FOR SWITCHES USING PANEL SEAL, DO NOT ALLOW THRU HOLE MOUNTING.

Key:  $\frac{0,0}{0.00} = \frac{\text{mm}}{\text{inches}}$

##### Pull-to-unlock toggle lever

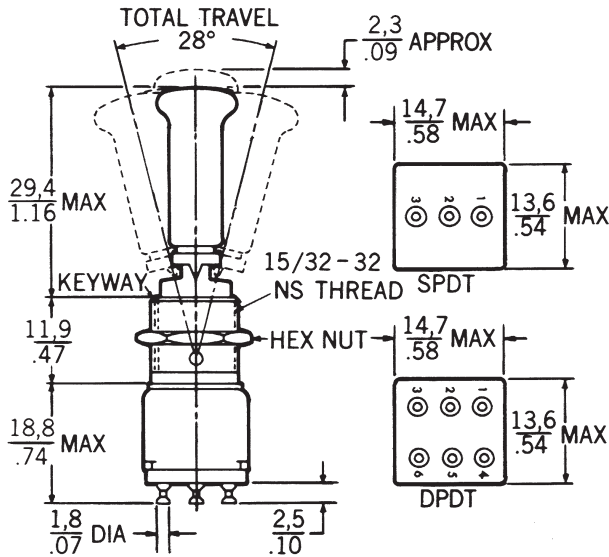

Bushing mounting torque is 10-15 in./lbs.