

Dimensions: mm (In)

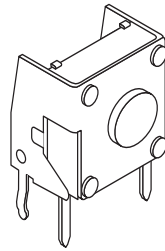

101-0163

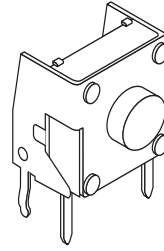

101-0263

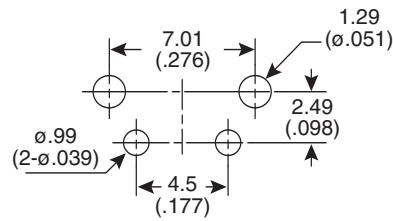
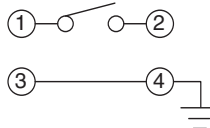
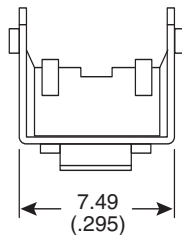

PCB Hole Layout

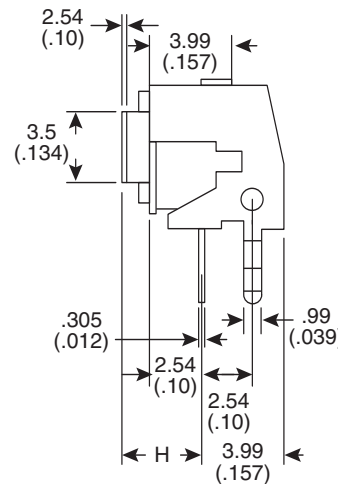
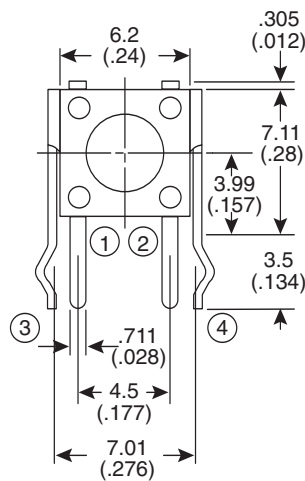

Mechanical Specifications:

- Temperature: -25°C ~ +70°C
- Operating force: 130 ±50gf
- Mechanical life: 500,000 cycles

Electrical Specifications:

- Rating: 50mA/12VDC
- Insulation resistance: >100MΩ @ 250VDC
- Dielectric Strength: 250VAC for 1 minute
- Contact resistance: <100MΩ
- Electrical life: 300,000 cycles

Material:

- Contact: phosphor bronze plated silver

Note:

- H: 124" (101-0163), .152" (101-0263)

Soldering Process:

- Temperature: 255°C max. 5 seconds

Tactile Switches (Thru-Hole)

101-0163, 101-0263

