

Product Family Overview

Introduction

Count controls are counters that provide output signal(s) at preset count value(s). Typical applications include cut-to-length, batching, filling, mixing and dispensing. Available from Eaton are a variety of count controls in different sizes, display types and feature sets.





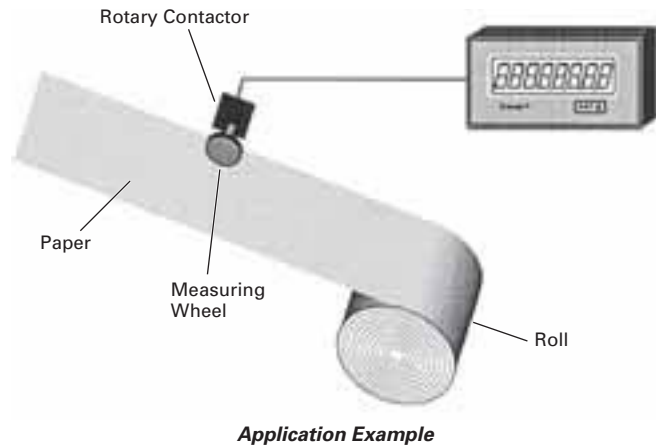

Application Example

The illustration shows a simple cut-to-length application. The roll of paper is measured using a measuring wheel and rotary contactor (or encoder). Once the desired length is reached, an output signal may be directed to a shear for activation. Following the cut-off, the count control will reset to zero and begin measurement of the next piece. Options such as batch counting, where the number of cut pieces is counted, are also typical of this application.



Count Control Product Family Overview

Table 36. Product Family Overview

Product Family	Characteristics	Panel Cutout in Inches (mm)	Page Number
 <i>E5-148-C</i>	<ul style="list-style-type: none"> Low cost, simple count control Various power options: battery, AC, DC Easy-to-change preset values 2-line display: input and preset values 	1.772 x 1.772 (45 x 45)	37
 <i>Eclipse</i>	<ul style="list-style-type: none"> 6-digit, super bright LED display Multiple models available: totalizers, ratemeters, count controls, digital panel meters and flow controls 	1.772 x 1.622 (45 x 92)	41
 <i>Ambassador</i>	<ul style="list-style-type: none"> 6-digit, high-visibility, 2-line LCD display User-configurable control inputs Highly flexible control/display 	2.667 x 2.667 (68 x 68)	43
 <i>President</i>	<ul style="list-style-type: none"> Bright LED display w/14 mm characters Simple configuration with 14-button tactile keypad Many different versions fit almost any application 	2.667 x 5.433 (68 x 138)	46
 <i>Fusion</i>	<ul style="list-style-type: none"> Integrated controller combines operator interface, ladder logic and high-speed counting 	2.667 x 5.433 (68 x 138)	79
 <i>Electromechanical</i>	<ul style="list-style-type: none"> Various price, voltage and size ranges for different duty cycles and environments Long life and always readable display 	Various Mounting Configurations	50

Contents

<i>Description</i>	<i>Page</i>
Count Control	
1/16 DIN Battery Powered LCD Count Control	37
1/16 DIN LCD Count Control	39
Eclipse Series	41
Ambassador Series	43
President Series	46
PD-Q and PD-ER Series	50



Cat. No. E5-148-C1400

Features

- Replacement for electromechanical preset counters
- No power supply necessary (battery operated)
- Count and reset input electrically separated from counter through optocoupler input range 12 – 250V AC/DC
- 2-line LC display count, preset and level of the output
- Screw terminal
- Data security, through two exchangeable lithium batteries, lifetime minimum 8 years
- Easy programming
- Counter presets easily via presetting keys allocated to each decade
- Output: Potential free relay, programmable normally open or normally closed contact

Standards and Certifications

- cRU®us Approval
- CE Marked

Technical Data and Specifications

- Power Supply: 2 pcs user exchangeable lithium batteries, Type 1/2 AA lithium 3.6V
- Display: 2-line LCD display, 6 digits; 999999, height of figure 0.28 Inch (7 mm) or 0.18 Inch (4.5 mm)
- Input: Reset, count and key lock inputs
- Polarity of the Inputs: Bidirectional optocoupler input for the reset count inputs; reset, count and keyboard lock is connected to 3V DC
- Min. pulse duration of the Inputs: Reset input 50 mS; keyboard lock input 15 mS
- Switching Levels of the Inputs —
 - Low: <3V AC/DC
 - High: 12 – 250V AC/DC
- Input Frequency: Max. 25 Hz
- Input Resistance: 110 kΩ
- Output: Bistable relay with potential free contact (programmable as normally closed or normally open contact)
- Max. Switching Voltage: 250V AC/220V DC
- Max. Switching Current: 2A
- Max. Switching Capacity: 60 VA/30W
- Output Response Time: <20 mS, max. 4 Hz
- Data Retention: Via 2 batteries, 8 years or 5x10⁶ power operations of the output relay and an ambient temperature of 77°F (25°C)
- Ambient Temperature: 14 to 122°F (-10 to 50°C)
- Storage Temperature: -13 to 140°F (-25 to 60°C)
- EMC: According to EC EMC directive 89/36/EWG, EN 61 000-6-4/ EN 55011 Class B, EN 61 000-6-2
- Protection: IP65 (front)
- Weight: Approx. 2.82 oz (80 g)

1/16 DIN Battery Powered LCD Count Control

Product Selection

Table 37. Product Selection — 1/16 DIN Battery Powered LCD Count Control

Description	Catalog Number	*
1 Preset Count Control		
Battery Power 1.89 x 1.89 Inch (48 x 48 mm)	E5-148-C1400	

Dimensions

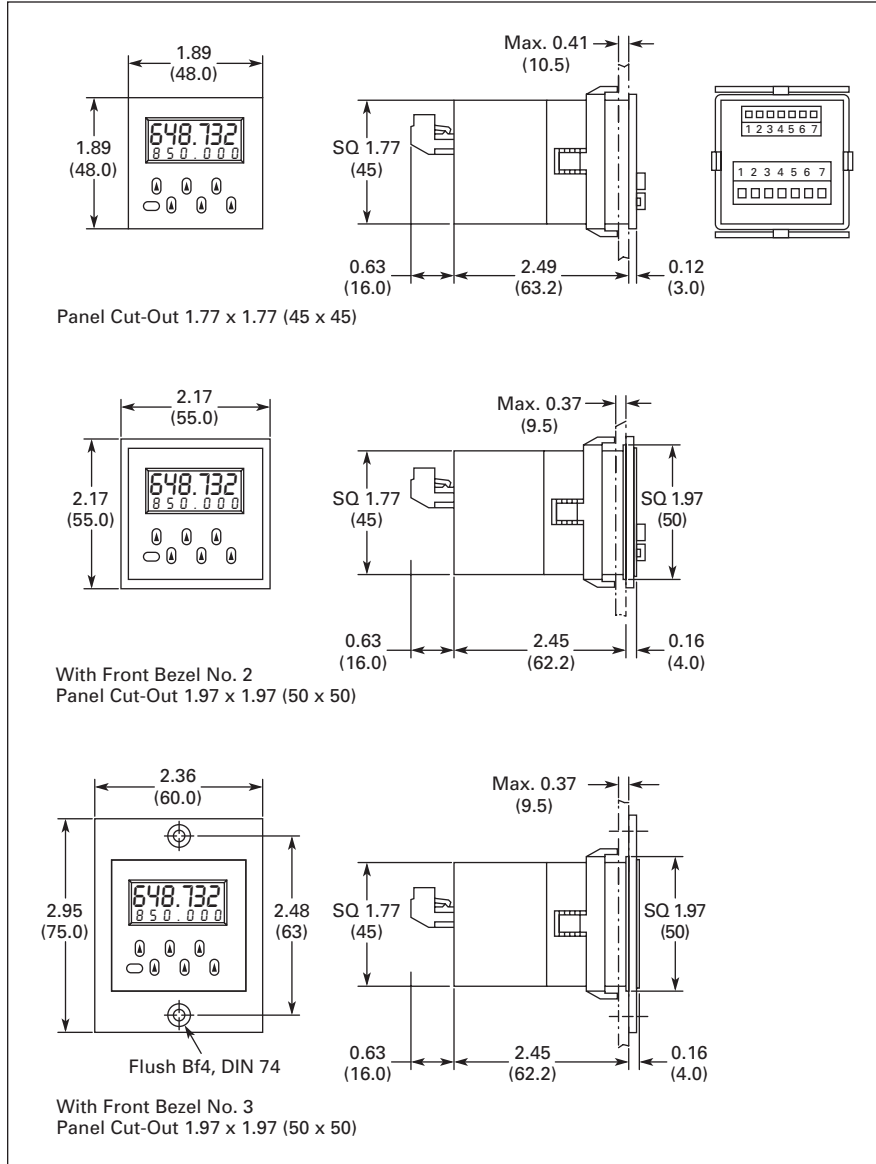

Figure 45. 1/16 DIN Battery Powered LCD Count Control — Approximate Dimensions in Inches (mm)

Discount Symbol CC-4