

5

4

3

2

1

D

C

B

A

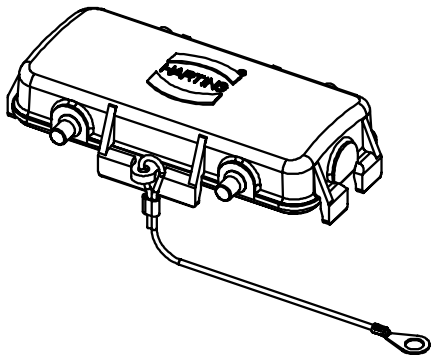
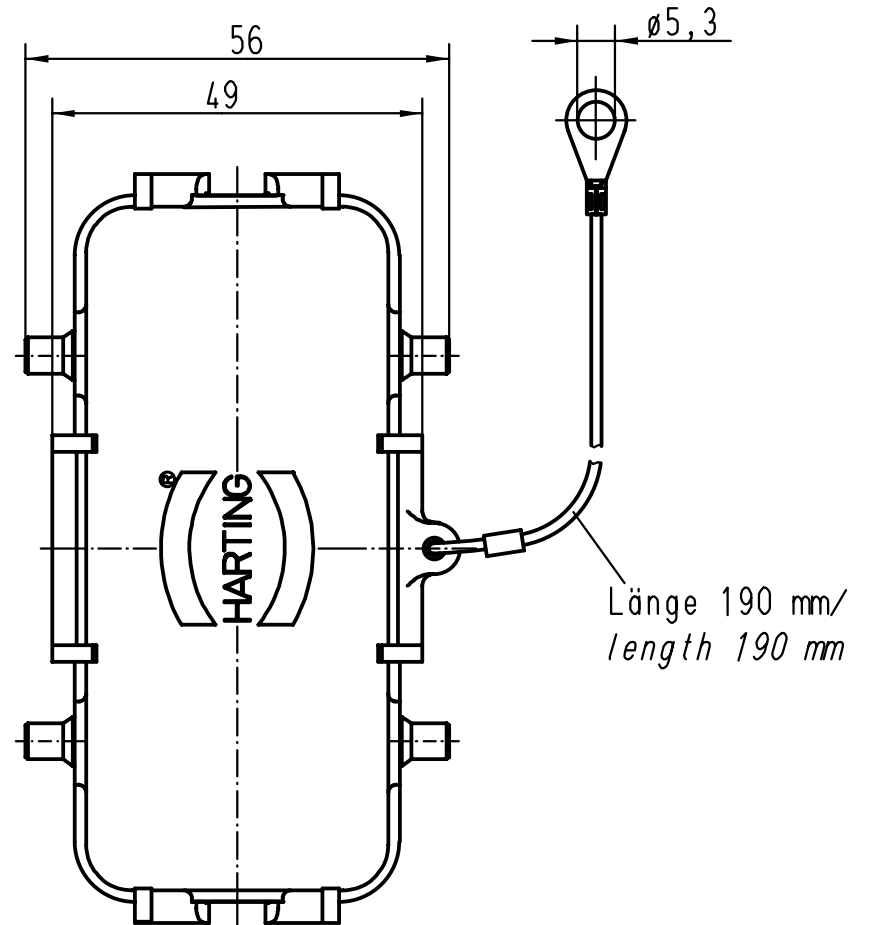
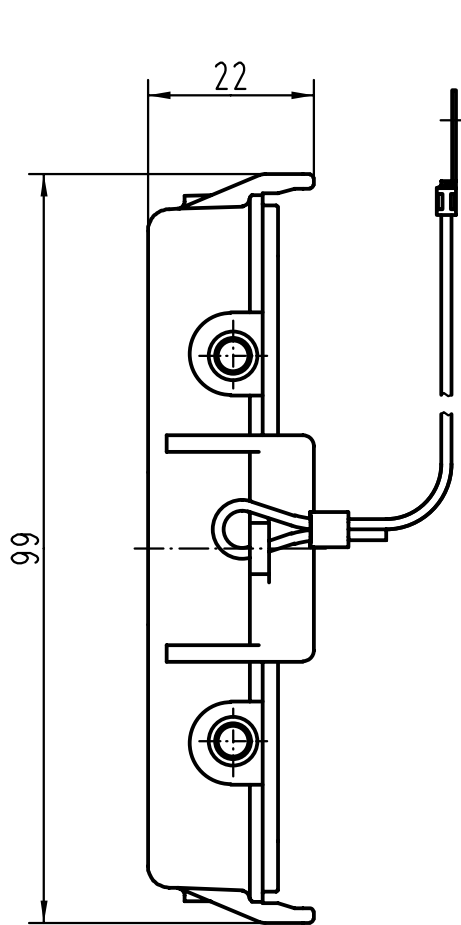

All Dimensions in mm Original Size DIN A 4		Techn. Character.			Nicht tolerierte Masse/ Free size tolerances		
			Dat.	Name	Massstab/ Scale 1:1	Han 16B-AK Metallabdeckkappe/ metal cover	
			Detail.	20.09.99			Gö
			Insp.				Sdt
			Stand.				
26788			HARTING KGaA			TB 09 30 016 5425 Sub. TB 09 30 0.. 5425 v. 03.02.93	
Mod.	Dat.	Name	D-32339 ESPELKAMP				
						Blatt/ page	