

Dimensions: mm (In.)

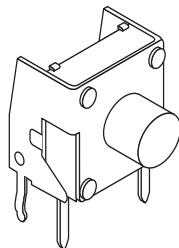

101-0363

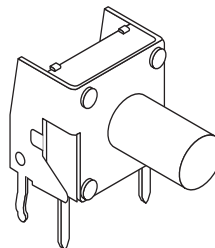

101-0463

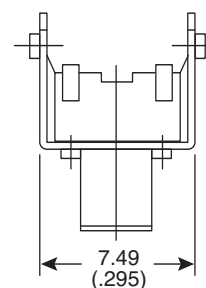
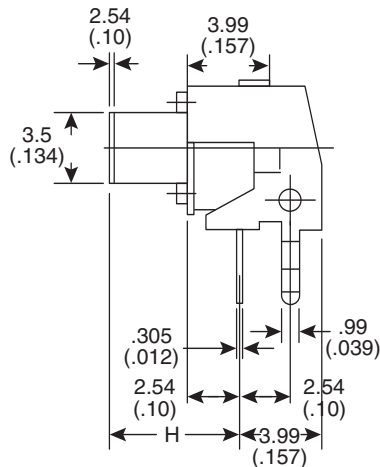
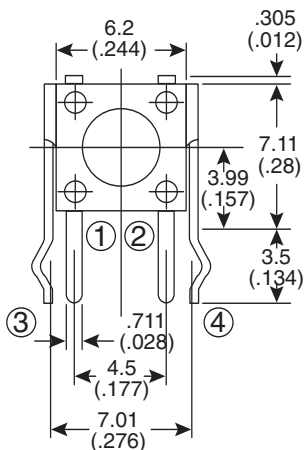
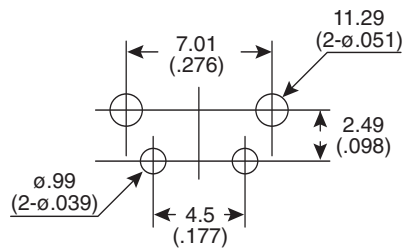
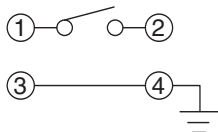

**Mechanical Specifications:**

- Mechanical life: 500,000 cycles
- Operating temperature: -25°C to +70°C
- Operating force: 130 ±30g

**Electrical Specifications:**

- Rating: 50mA/12VDC
- Insulation resistance: >100MΩ min. @ 250VDC
- Dielectric Strength: 250VAC for 1 minute
- Contact resistance: <100mΩ
- Electrical life: 300,000 cycles

**Material:**

- Contact: phosphor bronze plated silver

**Note:**

- H: 230" (101-0363), 329" (101-0463)

**Soldering Process:**

- Temperature: 255°C max. 5 seconds

**Tactile Switches (Thru-Hole)**

101-0363, 101-0463

