



*Representative photograph, actual product appearance may vary.*

*Due to regional agency approval requirements, some products may not be available in your area. Please contact your regional Honeywell office regarding your product of choice.*

## **RV6NAYSD502A**

**RV6 Series Industrial Potentiometer, Conductive Plastic Element, Solder hook Terminals, 0.5 W Power Rating, 5 kOhm Resistance Value**

### **Features**

- Compact - 12,7 mm [0.5 in] diameter
- Conductive plastic element
- Linear taper
- Robust nickel-plated brass shaft and bushings
- Meets MIL-PRF-94 standards
- Solder hook terminals

### **Typical Applications**

- Manual controls
- Medical equipment
- Telecommunications

### **Description**

The RV6 Series is a military qualified potentiometer made in accordance to MIL-PRF-94 specifications. It offers a 1/2 watt power rating and a conductive plastic element.

Product Specifications	
Potentiometer Type	Industrial
Element Type	Conductive Plastic
Terminal Type	Solder Hook
Power Rating	0.5 W
Resistance Value	5 kOhm
Resistance Tolerance	± 10 %
Linearity	± 5 %
Bushing Thread	6,35 mm [0.25 in] x 32 NEF-2A
Bushing length	6,35 mm [0.25 in]
Bushing Type	Standard
Shaft Diameter	3,18 mm [0.125 in]
Shaft length	22,22 mm [0.875 in]
Shaft Ending	Slotted
Body	12.7 mm [0.5 in] diameter, ± 0.79 mm [0.031 in]
Electrical Taper	Linear
Operating Temperature	-40 °C to 120 °C [-40 °F to 248 °F]
Working Voltage (Max.)	350 V
Rotational Life	50000 cycles
Mechanical Rotation	295°
Availability	Global
Series Name	RV6 Series
UNSPSC Code	4111363300
UNSPSC Commodity	4111363300 Potentiometers

**Honeywell**

## RV6NAYSD502A

RV6 Series Industrial Potentiometer, Conductive Plastic Element, Solder hook Terminals, 0.5 W Power Rating, 5 kOhm Resistance Value

For Reference Only in/mm

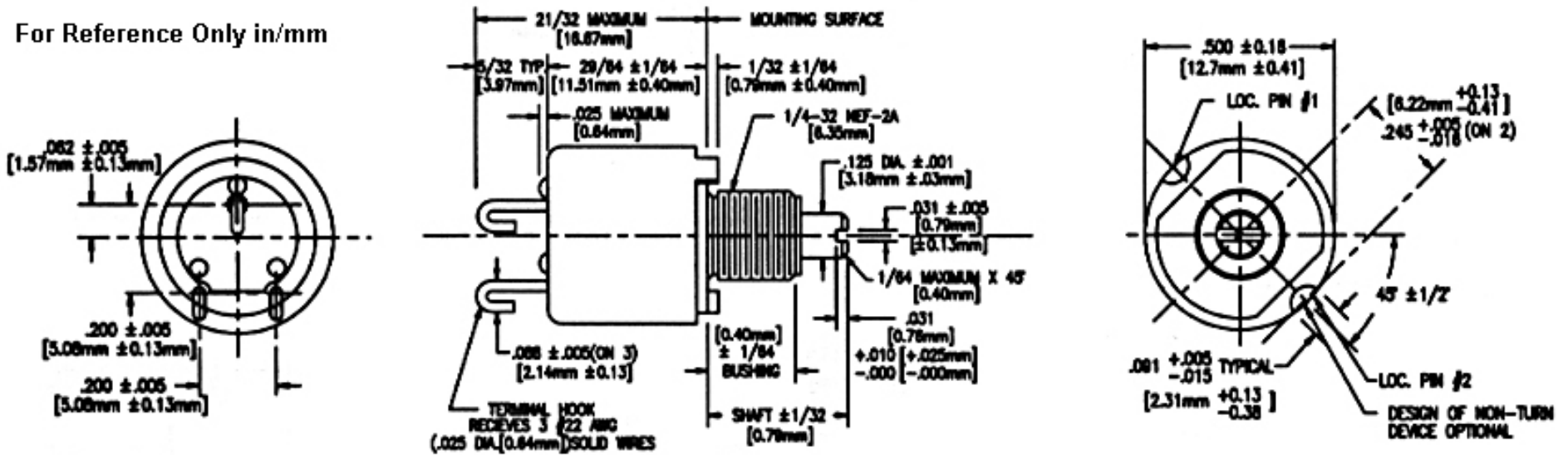

## SPLIT LOCKING BUSHING

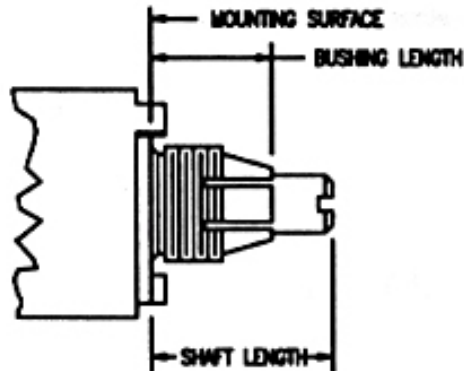

**Honeywell**

## RV6NAYSD502A

RV6 Series Industrial Potentiometer, Conductive Plastic Element, Solder hook Terminals, 0.5 W Power Rating, 5 kOhm Resistance Value

** WARNING**

**PERSONAL INJURY**

DO NOT USE these products as safety or emergency stop devices, or in any other application where failure of the product could result in personal injury.

**Failure to comply with these instructions could result in death or serious injury.**

** WARNING**

**MISUSE OF DOCUMENTATION**

- The information presented in this product sheet (or catalog) is for reference only. DO NOT USE this document as product installation information.
- Complete installation, operation and maintenance information is provided in the instructions supplied with each product.

**Failure to comply with these instructions could result in death or serious injury.**