

Mini Incandescents

T-2 Bulb

Line No.	Part Number	Base Type	Design Volts	Design Amps	End Foot Candela	Filament Type	Rated Life	Fig No.	Foot Notes
1	28PSB		Slide Base #5	28	0.04		<u>C-2F</u>	5,000	<u>51</u>

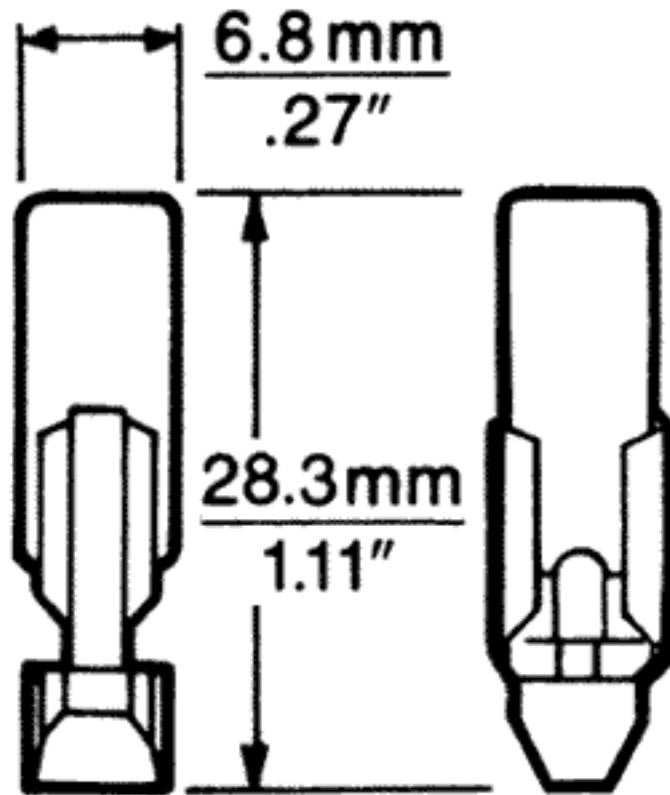

Fig. 51