

Surface Mount TRANSZORB® Transient Voltage Suppressors



DO-214AB (SMC)

PRIMARY CHARACTERISTICS	
V_{WM}	5.0 V to 188 V
P_{PPM}	1500 W
P_D	6.5 W
I_{FSM} (uni-directional only)	200 A
T_J max.	150 °C

DEVICES FOR BI-DIRECTION APPLICATIONS

For bi-directional devices use C or CA suffix (e.g. SMCJ188CA).

Electrical characteristics apply in both directions.

FEATURES

- Low profile package
- Ideal for automated placement
- Glass passivated chip junction
- Available in uni-directional and bi-directional
- Excellent clamping capability
- Very fast response time
- Low incremental surge resistance
- Meets MSL level 1, per J-STD-020, LF maximum peak of 260 °C
- Solder dip 260 °C, 40 s
- Component in accordance to RoHS 2002/95/EC and WEEE 2002/96/EC



RoHS
COMPLIANT

TYPICAL APPLICATIONS

Use in sensitive electronics protection against voltage transients induced by inductive load switching and lighting on ICs, MOSFET, signal lines of sensor units for consumer, computer, industrial, automotive and telecommunication.

MECHANICAL DATA

Case: DO-214AB (SMCJ)

Molding compound meets UL 94 V-0 flammability rating

Base P/N-E3 - RoHS compliant, commercial grade

Base P/NHE3 - RoHS compliant, high reliability/automotive grade (AEC Q101 qualified)

Terminals: Matte tin plated leads, solderable per J-STD-002 and JESD22-B102

E3 suffix meets JESD 201 class 1A whisker test, HE3 suffix meets JESD 201 class 2 whisker test

Polarity: For uni-directional types the band denotes cathode end, no marking on bi-directional types

MAXIMUM RATINGS ($T_A = 25$ °C unless otherwise noted)			
PARAMETER	SYMBOL	VALUE	UNIT
Peak pulse power dissipation with a 10/1000 μ s waveform ⁽¹⁾⁽²⁾	P_{PPM}	1500	W
Peak pulse current with a 10/1000 μ s waveform ⁽¹⁾	I_{PPM}	See next table	A
Peak forward surge current 8.3 ms single half sine-wave uni-directional only ⁽²⁾	I_{FSM}	200	A
Power dissipation on infinite heatsink, $T_A = 50$ °C	P_D	6.5	W
Operating junction and storage temperature range	T_J, T_{STG}	- 55 to + 150	°C

Notes:

(1) Non-repetitive current pulse, per Fig. 3 and derated above $T_A = 25$ °C per Fig. 2

(2) Mounted on 0.31 x 0.31" (8.0 x 8.0 mm) copper pads to each terminal

ELECTRICAL CHARACTERISTICS ($T_A = 25\text{ }^\circ\text{C}$ unless otherwise noted)									
DEVICE TYPE MODIFIED "J" BEND LEAD	DEVICE MARKING CODE		BREAKDOWN VOLTAGE V_{BR} AT I_T ⁽¹⁾ (V)		TEST CURRENT I_T (mA)	STAND-OFF VOLTAGE V_{WM} (V)	MAXIMUM REVERSE LEAKAGE AT V_{WM} I_D (μA) ⁽³⁾	MAXIMUM PEAK PULSE SURGE CURRENT I_{PPM} (A) ⁽²⁾	MAXIMUM CLAMPING VOLTAGE AT I_{PPM} V_C (V)
	UNI	BI	MIN.	MAX.					
(+)SMCJ5.0	GDD	GDD	6.40	7.82	10.0	5.0	1000	156.3	9.6
(+)SMCJ5.0A ⁽⁵⁾	GDE	GDE	6.40	7.07	10.0	5.0	1000	163.0	9.2
(+)SMCJ6.0	GDF	GDF	6.67	8.15	10.0	6.0	1000	131.6	11.4
(+)SMCJ6.0A	GDG	GDG	6.67	7.37	10.0	6.0	1000	145.6	10.3
(+)SMCJ6.5	GDH	BDH	7.22	8.82	10.0	6.5	500	122.0	12.3
(+)SMCJ6.5A	GDK	BDK	7.22	7.98	10.0	6.5	500	133.9	11.2
(+)SMCJ7.0	GDL	GDL	7.78	9.51	10.0	7.0	200	112.8	13.3
(+)SMCJ7.0A	GDM	GDM	7.78	8.60	10.0	7.0	200	125.0	12.0
(+)SMCJ7.5	GDN	BDN	8.33	10.2	1.0	7.5	100	104.9	14.3
(+)SMCJ7.5A	GDP	BDP	8.33	9.21	1.0	7.5	100	116.3	12.9
(+)SMCJ8.0	GDQ	BDG	8.89	10.9	1.0	8.0	50	100.0	15.0
(+)SMCJ8.0A	GDR	BDR	8.89	9.83	1.0	8.0	50	110.3	13.6
(+)SMCJ8.5	GDS	BDS	9.44	11.5	1.0	8.5	20	94.3	15.9
(+)SMCJ8.5A	GDT	BDT	9.44	10.4	1.0	8.5	20	104.2	14.4
(+)SMCJ9.0	GDU	BDU	10.0	12.2	1.0	9.0	10	88.8	16.9
(+)SMCJ9.0A	GDV	BDV	10.0	11.1	1.0	9.0	10	97.4	15.4
(+)SMCJ10	GDW	BDW	11.1	13.6	1.0	10	5.0	79.8	18.8
(+)SMCJ10A	GDX	BDX	11.1	12.3	1.0	10	5.0	88.2	17.0
(+)SMCJ11	GDY	GDY	12.2	14.9	1.0	11	5.0	74.6	20.1
(+)SMCJ11A	GDZ	GDZ	12.2	13.5	1.0	11	5.0	82.4	18.2
(+)SMCJ12	GED	BED	13.3	16.3	1.0	12	5.0	68.2	22.0
(+)SMCJ12A	GEE	BEE	13.3	14.7	1.0	12	5.0	75.4	19.9
(+)SMCJ13	GEF	GEF	14.4	17.6	1.0	13	1.0	63.0	23.8
(+)SMCJ13A	GEG	GEG	14.4	15.9	1.0	13	1.0	69.8	21.5
(+)SMCJ14	GEH	BEH	15.6	19.1	1.0	14	1.0	58.1	25.8
(+)SMCJ14A	GEK	BEK	15.6	17.2	1.0	14	1.0	64.7	23.2
(+)SMCJ15	GEL	BEL	16.7	20.4	1.0	15	1.0	55.8	26.9
(+)SMCJ15A	GEM	BEM	16.7	18.5	1.0	15	1.0	61.5	24.4
(+)SMCJ16	GEN	GEN	17.8	21.8	1.0	16	1.0	52.1	28.8
(+)SMCJ16A	GEP	GEP	17.8	19.7	1.0	16	1.0	57.7	26.0
(+)SMCJ17	GEQ	GEQ	18.9	23.1	1.0	17	1.0	49.2	30.5
(+)SMCJ17A	GER	GER	18.9	20.9	1.0	17	1.0	54.3	27.6
(+)SMCJ18	GES	BES	20.0	24.4	1.0	18	1.0	46.6	32.2
(+)SMCJ18A	GET	BET	20.0	22.1	1.0	18	1.0	51.4	29.2
(+)SMCJ20	GEU	BEU	22.2	27.1	1.0	20	1.0	41.9	35.8
(+)SMCJ20A	GEV	BEV	22.2	24.5	1.0	20	1.0	46.3	32.4
(+)SMCJ22	GEW	BEW	24.4	29.8	1.0	22	1.0	38.1	39.4
(+)SMCJ22A	GEX	BEX	24.4	26.9	1.0	22	1.0	42.3	35.5
(+)SMCJ24	GEY	BEY	26.7	32.6	1.0	24	1.0	34.9	43.0
(+)SMCJ24A	GEZ	BEZ	26.7	29.5	1.0	24	1.0	38.6	38.9
(+)SMCJ26	GFD	BFD	28.9	35.3	1.0	26	1.0	32.2	46.6
(+)SMCJ26A	GFE	BFE	28.9	31.9	1.0	26	1.0	35.6	42.1
(+)SMCJ28	GFF	BFF	31.1	38.0	1.0	28	1.0	30.0	50.0
(+)SMCJ28A	GFG	BFG	31.1	34.4	1.0	28	1.0	33.0	45.4
(+)SMCJ30	GFH	BFH	33.3	40.7	1.0	30	1.0	28.0	53.5
(+)SMCJ30A	GFK	BFK	33.3	36.8	1.0	30	1.0	31.0	48.4
(+)SMCJ33	GFL	BFL	36.7	44.9	1.0	33	1.0	25.4	59.0
(+)SMCJ33A	GFM	BFM	36.7	40.6	1.0	33	1.0	28.1	53.3
(+)SMCJ36	GFN	BFN	40.0	48.9	1.0	36	1.0	23.3	64.3
(+)SMCJ36A	GFP	BFP	40.0	44.2	1.0	36	1.0	25.8	58.1
(+)SMCJ40	GFQ	BFQ	44.4	54.3	1.0	40	1.0	21.0	71.4
(+)SMCJ40A	GFR	BFR	44.4	49.1	1.0	40	1.0	23.3	64.5



ELECTRICAL CHARACTERISTICS (T _A = 25 °C unless otherwise noted)									
DEVICE TYPE MODIFIED "J" BEND LEAD	DEVICE MARKING CODE		BREAKDOWN VOLTAGE V _{BR} AT I _T ⁽¹⁾ (V)		TEST CURRENT I _T (mA)	STAND-OFF VOLTAGE V _{WM} (V)	MAXIMUM REVERSE LEAKAGE AT V _{WM} I _D (μA) ⁽³⁾	MAXIMUM PEAK PULSE SURGE CURRENT I _{PPM} (A) ⁽²⁾	MAXIMUM CLAMPING VOLTAGE AT I _{PPM} V _C (V)
	UNI	BI	MIN.	MAX.					
(+)SMCJ43	GFS	BFS	47.8	58.4	1.0	43	1.0	19.6	76.7
(+)SMCJ43A	GFT	BFT	47.8	52.8	1.0	43	1.0	21.6	69.4
(+)SMCJ45	GFU	GFU	50.0	61.1	1.0	45	1.0	18.7	80.3
(+)SMCJ45A	GFV	GFV	50.0	55.3	1.0	45	1.0	20.6	72.7
(+)SMCJ48	GFW	GFW	53.3	65.1	1.0	48	1.0	17.5	85.5
(+)SMCJ48A	GFX	GFX	53.3	58.9	1.0	48	1.0	19.4	77.4
(+)SMCJ51	GFY	GFY	56.7	69.3	1.0	51	1.0	16.5	91.1
(+)SMCJ51A	GFZ	GFZ	56.7	62.7	1.0	51	1.0	18.2	82.4
(+)SMCJ54	GGD	GGD	60.0	73.3	1.0	54	1.0	15.6	96.3
(+)SMCJ54A	GGE	GGE	60.0	66.3	1.0	54	1.0	17.2	87.1
(+)SMCJ58	GGF	GGF	64.4	78.7	1.0	58	1.0	14.6	103
(+)SMCJ58A	GGG	GGG	64.4	71.2	1.0	58	1.0	16.0	93
(+)SMCJ60	GGH	GGH	66.7	81.5	1.0	60	1.0	14.0	107
(+)SMCJ60A	GGK	GGK	66.7	73.7	1.0	60	1.0	15.5	96
(+)SMCJ64	GGL	GGL	71.1	86.9	1.0	64	1.0	13.2	114
(+)SMCJ64A	GGM	GGM	71.1	78.6	1.0	64	1.0	14.6	103
(+)SMCJ70	GGN	GGN	77.8	95.1	1.0	70	1.0	12.0	125
(+)SMCJ70A	GGP	GGP	77.8	86.0	1.0	70	1.0	13.3	113
(+)SMCJ75	GGQ	GGQ	83.3	102	1.0	75	1.0	11.2	134
(+)SMCJ75A	GGR	GGR	83.3	92.1	1.0	75	1.0	12.4	121
(+)SMCJ78	GGS	GGS	86.7	106	1.0	78	1.0	10.8	139
(+)SMCJ78A	GGT	GGT	86.7	95.8	1.0	78	1.0	11.9	126
(+)SMCJ85	GGU	GGU	94.4	115	1.0	85	1.0	9.9	151
(+)SMCJ85A	GGV	GGV	94.4	104	1.0	85	1.0	10.9	137
(+)SMCJ90	GGW	GGW	100	122	1.0	90	1.0	9.4	160
(+)SMCJ90A	GGX	GGX	100	111	1.0	90	1.0	10.3	146
(+)SMCJ100	GGY	GGY	111	136	1.0	100	1.0	8.4	179
(+)SMCJ100A	GGZ	GGZ	111	123	1.0	100	1.0	9.3	162
(+)SMCJ110	GHD	GHD	122	149	1.0	110	1.0	7.7	196
(+)SMCJ110A	GHE	GHE	122	135	1.0	110	1.0	8.5	177
(+)SMCJ120	GHF	GHF	133	163	1.0	120	1.0	7.0	214
(+)SMCJ120A	GHG	GHG	133	147	1.0	120	1.0	7.8	193
(+)SMCJ130	GHH	GHH	144	176	1.0	130	1.0	6.5	231
(+)SMCJ130A	GHK	GHK	144	159	1.0	130	1.0	7.2	209
(+)SMCJ150	GHL	GHL	167	204	1.0	150	1.0	5.6	268
(+)SMCJ150A	GHM	GHM	167	185	1.0	150	1.0	6.2	243
(+)SMCJ160	GHN	GHN	178	218	1.0	160	1.0	5.2	287
(+)SMCJ160A	GHP	GHP	178	197	1.0	160	1.0	5.8	259
(+)SMCJ170	GHQ	GHQ	189	231	1.0	170	1.0	4.9	304
(+)SMCJ170A	GHR	GHR	189	209	1.0	170	1.0	5.5	275
SMCJ188	GHT	GHT	209	255	1.0	188	1.0	4.4	344
SMCJ188A	GHS	GHS	209	231	1.0	188	1.0	4.6	328

Notes:

- (1) Pulse test: t_p ≤ 50 ms
- (2) Surge current waveform per Fig. 3 and derate per Fig. 2
- (3) For bi-directional types having V_{WM} of 10 V and less, the I_D limit is doubled
- (4) All terms and symbols are consistent with ANSI/IEEE C62.35
- (5) For the bi-directional SMCJ5.0CA, the maximum V_{BR} is 7.25 V
- (6) V_F = 3.5 V at I_F = 100 A (uni-directional only)
- (+) Underwriters laboratory recognition for the classification of protectors (QVGQ2) under the UL standard for safety 497B and file number E136766 for both uni-directional and bi-directional devices

THERMAL CHARACTERISTICS ($T_A = 25\text{ }^\circ\text{C}$ unless otherwise noted)

PARAMETER	SYMBOL	VALUE	UNIT
Typical thermal resistance, junction to ambient air ⁽¹⁾	$R_{\theta JA}$	75	$^\circ\text{C/W}$
Typical thermal resistance, junction to leads	$R_{\theta JL}$	15	$^\circ\text{C/W}$

Note:

(1) Mounted on minimum recommended pad layout

ORDERING INFORMATION (Example)

PREFERRED P/N	UNIT WEIGHT (g)	PREFERRED PACKAGE CODE	BASE QUANTITY	DELIVERY MODE
SMCJ5.0A-E3/57T	0.211	57T	850	7" diameter plastic tape and reel
SMCJ5.0A-E3/9AT	0.211	9AT	3500	13" diameter plastic tape and reel
SMCJ5.0AHE3/57T ⁽¹⁾	0.211	57T	850	7" diameter plastic tape and reel
SMCJ5.0AHE3/9AT ⁽¹⁾	0.211	9AT	3500	13" diameter plastic tape and reel

Note:

(1) Automotive grade AEC Q101 qualified

RATINGS AND CHARACTERISTICS CURVES

($T_A = 25\text{ }^\circ\text{C}$ unless otherwise noted)

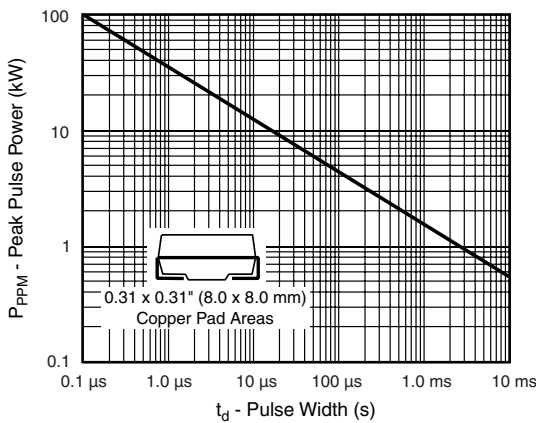

Figure 1. Peak Pulse Power Rating Curve

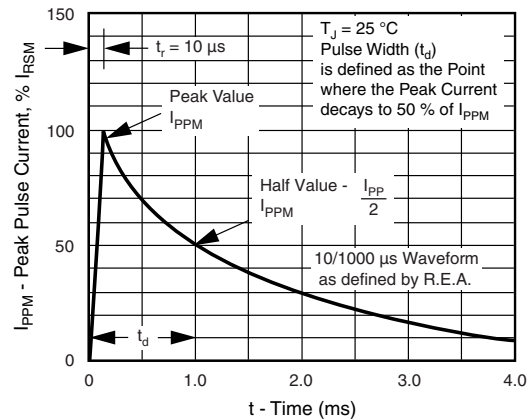

Figure 3. Pulse Waveform

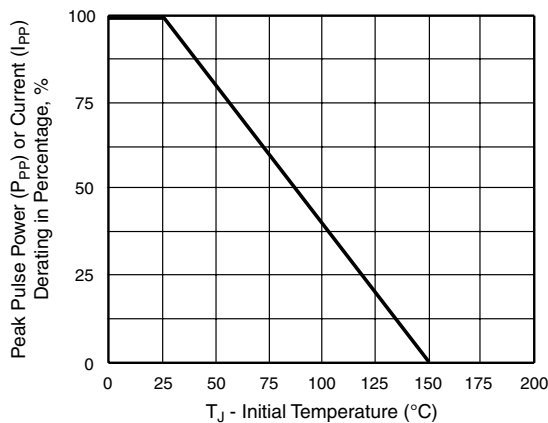

Figure 2. Pulse Power or Current vs. Initial Junction Temperature

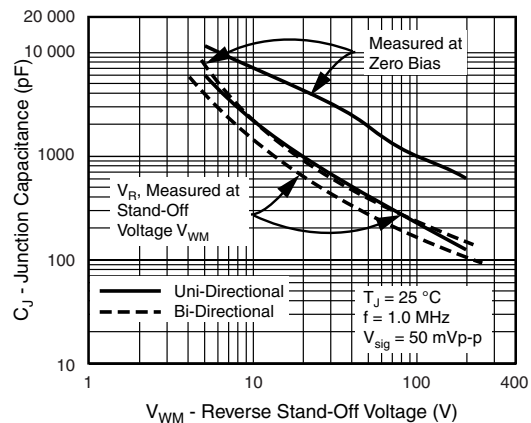

Figure 4. Typical Junction Capacitance Uni-Directional

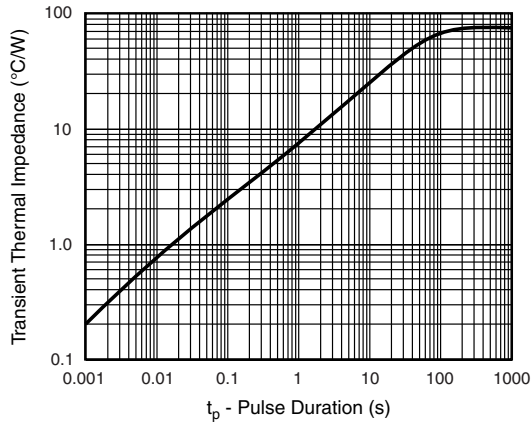

Figure 5. Typical Transient Thermal Impedance

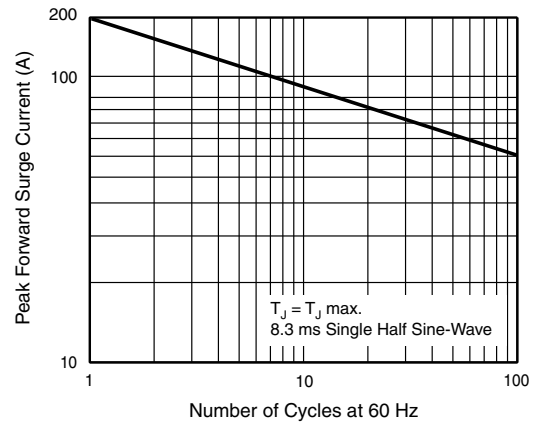
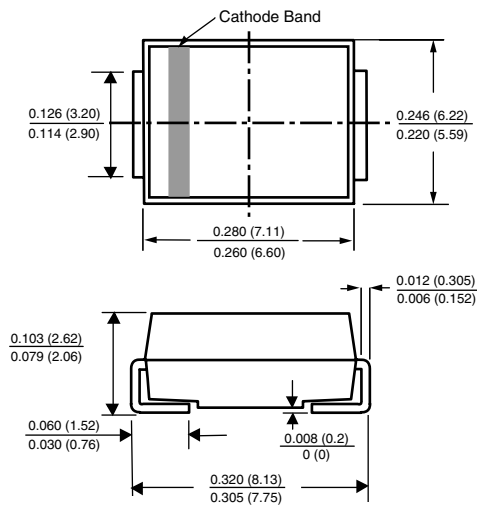

Figure 6. Maximum Non-Repetitive Forward Surge Current
Uni-Directional Use Only

PACKAGE OUTLINE DIMENSIONS in inches (millimeters)

DO-214AB (SMC J-Bend)



Mounting Pad Layout

