

Free eNewsletter

Enter your E-mail



#### Shop By Type

Cable Assemblies  
Adapters  
Connectors  
Rack Panels  
Bulk Cable  
Tools  
Switch Boxes  
Network Cards  
Hubs & Switches  
Converters & Transceivers  
KVM Switches  
Antennas

Overstock/Sale Items  
Top 10 Products

#### Shop By Category

IEEE-488 GPIB  
Coaxial  
Monitor, Video  
Fiber Optic  
D-Subminiature  
Modular  
USB, DIN, Firewire, SCSI, and Others  
Wireless Infrastructure  
Weatherproof Enclosures  
Networking and Other Equipment

#### Product Wizards

Cable Assemblies  
Adapters  
Connectors  
Rack Panels  
Tools  
Switch Boxes  
Network Cards  
Hubs or Switches  
Ethernet Converters  
KVM Switches

#### Technical Resources

FAQs  
Connector Chart  
Glossary  
Tutorials  
Tips and Videos  
White Papers  
Catalog Downloads  
eNewsletter Archive

You Are Here: [Home](#) > [Modular](#) > [Adapters, Couplers, Splitters](#) > [Modular Couplers](#) > [ECF504B](#) > **ECF504B-6S**

## Modular Coupler, RJ12 (6x6), Straight, 50μ, Black, Deluxe Panel

L-com's exclusive line of category 3 panel mount connectors is the perfect choice for passing modular cables through a rack panel or wall plate. The unique flange mount design accepts #4 or #5 screws for secure mounting of these couplers to any panel (purchased separately). Contacts have 30 microinches of gold plating for durability and the black plastic shell is UL94V-0 rated. With a category 3 rating these couplers can be used for either voice or data applications. Large volume discounts offered; Call today.



#### Features for this Modular product

- Category 3 RJ45 Panel Mount Coupler, USOC Straight wired for voice or data applications
- Flange mount design accepts #4 or #5 screws for secure panel mounting
- 30 microinches gold plating for a durable connection
- UL94V-0 rated ivory plastic shell for ruggedness
- Category 3 rated for data and voice applications

#### Details for this Modular product

L-com Item #	ECF504B-6S
Manufacturer	L-com
ASIN # <a href="#">(More)</a>	B000AAL6VW
UPC # <a href="#">(More)</a>	822335022393
RoHS Status	<a href="#">RoHS Compliant</a> <a href="#">(More)</a>

[Diagram](#)

[Catalog Page](#)

[2D Drawing \(.pdf\)](#)

[3D CAD Model \(.step\)](#)

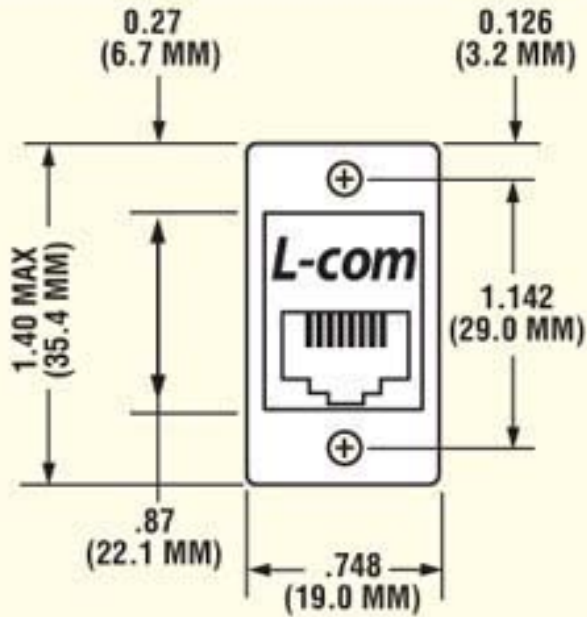

ECF & ECJ Front View

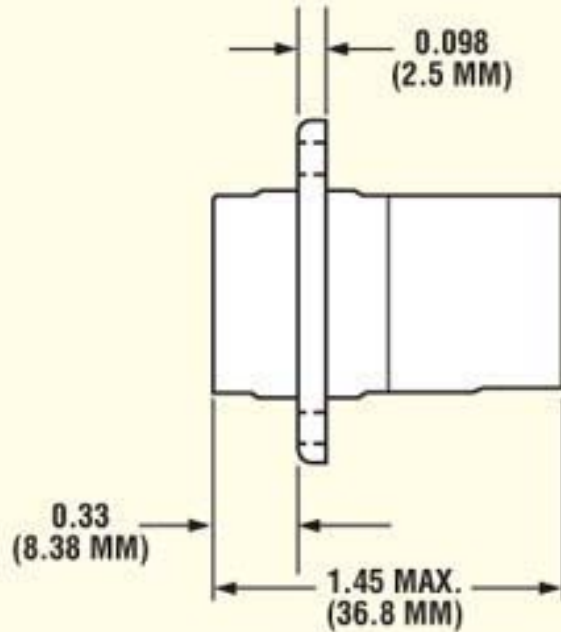

ECF Side View

USB Style Connectors

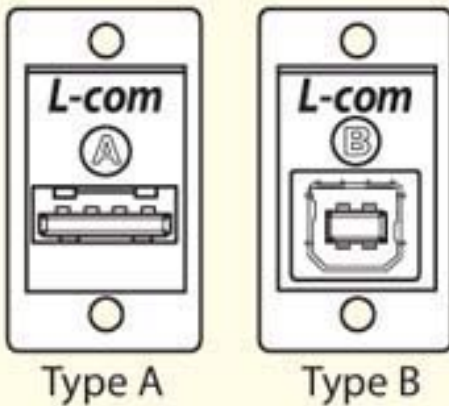

USB Type A & B

ECF & ECJ Series  
RECOMMENDED PANEL  
HOLES

DRILL AND TAP  
HOLES FOR  
4-40 SCREW

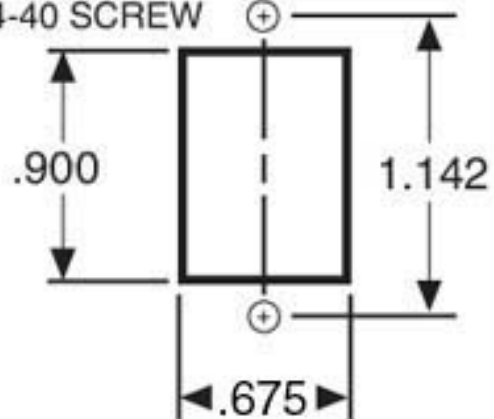

**ECF504 Series**



Network Rating: Category 3  
Color: Ivory  
Gold Plating: 30 microinches  
Flammability Rating: 94V-0

**ECJ504 Series**



ECJ504 Series Front View

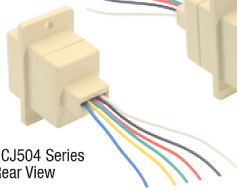

ECJ504 Series Rear View

Color: Ivory  
Gold Plating: 30 microinches  
Flammability Rating: 94V-0

**ECF504B Series**



Network Rating: Category 3  
Color: Black  
Gold Plating: 50 microinches  
Flammability Rating: 94V-0



PR175F504-8S

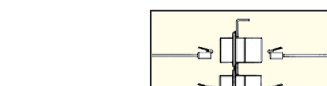

PR175F504-8SK



PR175F504-6C



PR175F504-8C



PR35F504-6S

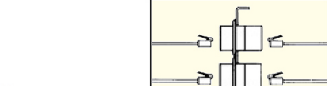

PR175F504B-4S



PR35F504B-4S

Item #	Description	Color	1-9	10-24	25-99	100-249	250-499
--------	-------------	-------	-----	-------	-------	---------	---------

**RoHS Compliant Deluxe Panel Mounted Modular Couplers, 30 Microinches Gold, Ivory Color**

These straight and cross wired modular couplers are available exclusively from L-com. Eight different configurations all fit into the same 0.675 x 0.900 inch rectangular opening. Wire contacts have 30 microinch gold plating for multiple insertions. Plastic is 94V-0 rated. Color: Ivory. Flange accepts #4 or #5 mounting screws to be purchased separately. Category 3 rated.

<a href="#">ECF504-4C</a>	Modular Coupler, RJ11 (6x4), Crossed, 30µ	Ivory					
<a href="#">ECF504-6C</a>	Modular Coupler, RJ12 (6x6), Crossed, 30µ	Ivory					
<a href="#">ECF504-6CMJ</a>	Modular Coupler, MMJ (6x6), Crossed, 30µ	Ivory					
<a href="#">ECF504-8C</a>	Modular Coupler, RJ45 (8x8), Crossed, 30µ	Ivory					
<a href="#">ECF504-4S</a>	Modular Coupler, RJ11 (6x4), Straight, 30µ	Ivory					
<a href="#">ECF504-6S</a>	Modular Coupler, RJ12 (6x6), Straight, 30µ	Ivory					
<a href="#">ECF504-6SMJ</a>	Modular Coupler, MMJ (6x6), Straight, 30µ	Ivory					
<a href="#">ECF504-8SK</a>	Modular Coupler, RJ45 (8x8K), Straight, 30µ	Ivory					
<a href="#">ECF440</a>	Machine Screws, 4-40 x 5/16", Pkg/100						

**RoHS Compliant Deluxe Panel Mounted Modular Jacks - 10" Wire Leads, 30 Microinches Gold, Ivory Color**

One difficulty in using modular jacks is the mounting problem on a panel. L-com's solution to this problem is providing a flange that mounts with two screws in a 0.675" x 0.900" rectangular opening. Choice of RJ11/12 (6x6) or RJ45 (8x8K) usable with keyed or non-keyed plugs. Custom versions of other jack types considered in quantities of 500/up. Mounting screws must be purchased separately.

<a href="#">ECJ504-6</a>	Modular Panel Jack, RJ12 (6x6) / Wires, 30µ	Ivory					
<a href="#">ECJ504-8</a>	Modular Panel Jack, RJ45K (8x8K), / Wires, 30µ	Ivory					
<a href="#">ECF440</a>	Machine Screws, 4-40 x 5/16", Pkg/100						

**RoHS Compliant Deluxe Panel Mounted Couplers, 50 Microinches Gold, Black Color**

These couplers are similar to the ECF504 Series with two changes. The molding has been changed to a black color for applications when ivory is not wanted. Also, the contacts have 50 microinches of gold for superior mating with modular plugs. Mounting screws must be purchased separately. Category 3 rated.

<a href="#">ECF504B-4S</a>	Modular Coupler, RJ11 (6x4), Straight, 50µ	Black					
<a href="#">ECF504B-6S</a>	Modular Coupler, RJ12 (6x6), Straight, 50µ	Black					
<a href="#">ECF504B-8SK</a>	Modular Coupler, RJ45K (8x8K), Straight, 50µ	Black					
<a href="#">ECF440</a>	Machine Screws, 4-40 x 5/16", Pkg/100						

**RoHS Compliant 19" Patch Panels - Equipped with 16 or 32 ECF504 Series Modular Couplers**

These 19" patch panels utilize the ECF504 series couplers. For your convenience, two panel heights are offered; 1.75" with 16 modular adapters or 3.5" with 32 modular adapters. Panel legend is 1-16 or 1-32. Color: Bone. Available in straight or crossed wiring.

<a href="#">PR175F504-6S</a>	1.75" 16 Port Panel RJ12 (6x6), Straight-Thru	Bone					
<a href="#">PR175F504-8SK</a>	1.75" 16 Port Panel RJ45 (8x8), Straight, Keyed	Bone					
<a href="#">PR175F504-6C</a>	1.75" 16 Port Panel RJ12 (6x6), Crossed	Bone					
<a href="#">PR175F504-8C</a>	1.75" 16 Port Panel RJ45 (8x8), Crossed	Bone					
<a href="#">PR35F504-6S</a>	3.50" 32 Port Panel RJ12 (6x6), Straight-Thru	Bone					
<a href="#">PR35F504-8SK</a>	3.50" 32 Port Panel RJ45 (8x8), Straight, Keyed	Bone					
<a href="#">PR35F504-6C</a>	3.50" 32 Port Panel RJ12 (6x6), Crossed	Bone					
<a href="#">PR35F504-8C</a>	3.50" 32 Port Panel RJ45 (8x8), Crossed	Bone					

**How Rack Spaces and Sizes are Measured**

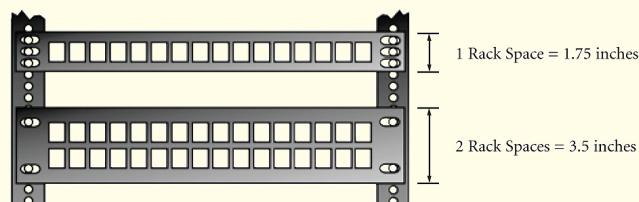

Racks are a great way to neaten up wiring closets and labs. Network equipment and rack panels usually come in 1.75", 3.5" and 5.25" heights. (1, 2 and 3 rack spaces).

**RoHS Compliant 19" Modular Patch Panels - Equipped with 16 or 32 ECF504B Modular Couplers**

These panels utilize the ECF504B couplers with 50 microinch plating. 16 and 32 port available. Straight thru pinned only. Color: Black.

<a href="#">PR175F504B-4S</a>	1.75" 16 Port Panel RJ11 (6x4), Straight-Thru	Black					
<a href="#">PR175F504B-6S</a>	1.75" 16 Port Panel RJ12 (6x6), Straight-Thru	Black					
<a href="#">PR175F504B-8SK</a>	1.75" 16 Port Panel RJ45 (8x8), Straight, Keyed	Black					
<a href="#">PR35F504B-4S</a>	3.50" 32 Port Panel RJ11 (6x4), Straight-Thru	Black					
<a href="#">PR35F504B-6S</a>	3.50" 32 Port Panel RJ12 (6x6), Straight-Thru	Black					
<a href="#">PR35F504B-8SK</a>	3.50" 32 Port Panel RJ45 (8x8), Straight, Keyed	Black					