

# UL 489 DIN Rail Miniature Circuit Breakers

- Product Overview ..... 2
- Product Selection ..... 4
- Accessories ..... 6
- Technical Data ..... 10

# UL 489 DIN Rail Miniature Circuit Breakers

## WMZT Circuit Breakers

### PRODUCT OVERVIEW

#### Optimum and Efficient Protection for Every Application



Optimum product quality, tested reliability and safety stand for best protection of personnel, installations and plant. Eaton's WMZT DIN rail mountable circuit breaker is designed for use in branch service applications.

#### Powerful Offering for Machine and System Builders

The WMZT is available with C and D characteristics in accordance with UL 489, CSA C22.2 No.5; UL 1077, CSA C22.2 No.235 and IEC 60947-2.

#### Typical Applications

##### Feeder and Branch Circuit Protection

- Convenience receptacle circuits (internal / external)
- Motor control circuits
- Load circuits leaving the equipment (external)
- HACR Equipment (Heating, Air Conditioning, Refrigeration) (internal / external)
- PLC I/O points
- Computers
- Power supplies
- Control instrumentation
- Relays
- UPS
- Power conditioners

#### Features

- Complete range of UL 489 listed DIN rail mounted miniature circuit breakers up to 40 ampere current rating
- Complete family rated for 10 kAIC @ 277/480 Vac
- Current limiting design provides fast short circuit interruption that reduces the let-through energy, which can damage the circuit
- Suitable for branch circuit device protection
- Thermal-magnetic overcurrent protection
  - Two levels of short circuit protection, categorized by C and D curves
- Trip-free design — breaker can not be defeated by holding the handle in the "on" position
- Captive screws cannot be lost
- SWD (switching duty) — suitable for switching fluorescent lighting loads ( $I_n \leq 20A$ )
- Fulfill UL 489, CSA C22.2 No.5 and also IEC 60947-2 Standard
- For use in applications for which UL 1077 or CSA C22.2 No.235 are also allowed
- Field installable shunt trip and auxiliary switch subsequent mounting
- Separate version for ring torque connection (Type WMZT....T), terminal screws can be removed (on both sides)
- Module width of only 17.7 mm (per pole)
- Contact Position Indicator (red / green)
- Easy installation on DIN rail
- Possibility for sealing the toggle in "on" or "off" position

# UL 489 DIN Rail Miniature Circuit Breakers

## WMZT Circuit Breakers PRODUCT OVERVIEW

### WMZT Complies with the Latest National and International Standards

#### Standards — Feeder and Branch Circuit Protection

##### UL 489

Standard for molded case circuit breakers (MCCB) for feeder and branch circuit protection.	
Products meet the requirements of the National Electrical Code® (NEC®).	

##### CSA C22.2 No.5

Standard for molded case circuit breakers (MCCB) for feeder and branch circuit protection (corresponds closely to UL 489 Standard).	
Products meet the requirements of the Canadian Electrical Code (CEC).	

### Tripping characteristics

Eaton WMZT branch circuit breakers are available with “C” and “D” tripping characteristics.

C-curve devices are suitable for application where medium levels of inrush current are expected. Applications include small transformers, lighting, pilot devices, control circuits, and coils. C-curve devices provide a medium magnetic trip point.

D-curve devices are suitable for applications where high levels of inrush current are expected. The high magnetic trip point prevents nuisance tripping in high inductive applications such as motors, transformers and power supplies.

Eaton WMZT devices are current limiting, which means they interrupt fault currents within one half cycle of the fault. Current limiting devices offer superior protection by reducing peak let-through current and energy.

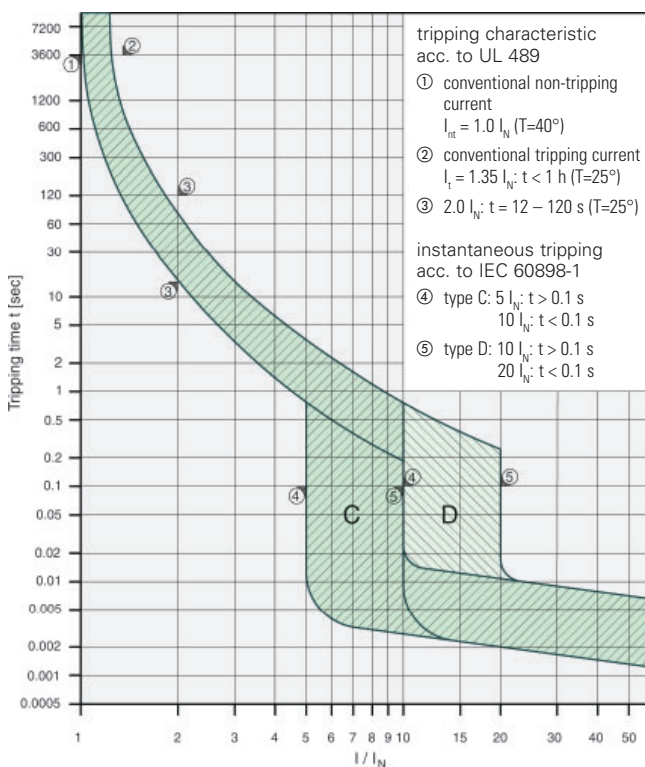

### Device Printing on Front and Side

Installation options

WMZT branch circuit breakers are available in two terminal configurations; standard box terminals that accept multiple conductors and ring-tongue terminals, ideally suited to demanding requirements of the semi-conductor industry. All breakers mount on standard 35 mm DIN rail. Bus connectors and feeder terminal facilitate mounting and wiring of multiple miniature circuit breaker arrays in control panel assemblies. WMZT circuit breakers can also be reverse feed.

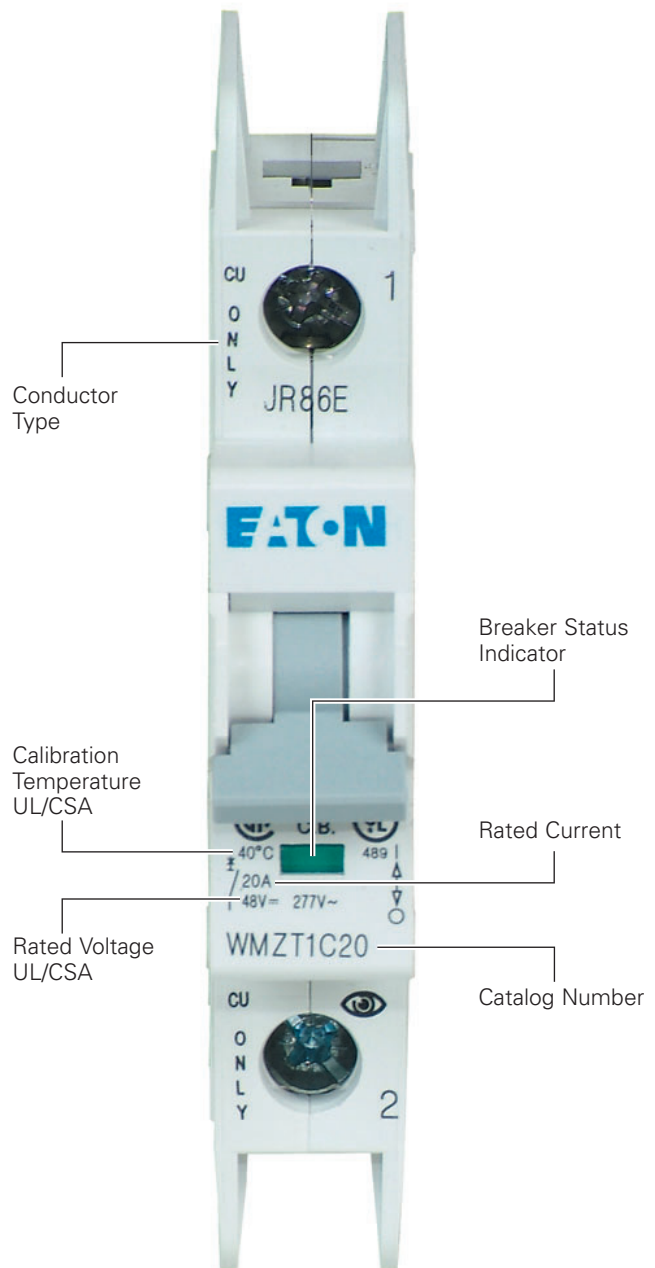



# UL 489 DIN Rail Miniature Circuit Breakers

## WMZT Circuit Breakers

### PRODUCT SELECTION

#### WMZT UL 489 Circuit Breakers

		
<b>1-Pole</b>	<b>2-Pole</b>	<b>3-Pole</b>
<b>Catalog Number</b>	<b>Catalog Number</b>	<b>Catalog Number</b>

- UL approved (UL 489) and CSA Certified (CSA C22.2 No.5-02) as Branch Circuit Breakers
- Interrupting capacity: 10 kA UL/CSA; 15 kA IEC 60947
- Current limiting device

#### C Curve (5 – 10X I<sub>n</sub> Current Rating)

0.5	WMZT1CX0	WMZT2CX0	WMZT3CX0
1	WMZT1C01	WMZT2C01	WMZT3C01
1.5	WMZT1CX1	WMZT2CX1	WMZT3CX1
2	WMZT1C02	WMZT2C02	WMZT3C02
3	WMZT1C03	WMZT2C03	WMZT3C03
4	WMZT1C04	WMZT2C00	WMZT3C04
5	WMZT1C05	WMZT2C05	WMZT3C05
6	WMZT1C06	WMZT2C06	WMZT3C06
7	WMZT1C07	WMZT2C07	WMZT3C07
8	WMZT1C08	WMZT2C08	WMZT3C08
10	WMZT1C10	WMZT2C10	WMZT3C10
13	WMZT1C13	WMZT2C13	WMZT3C13
15	WMZT1C15	WMZT2C15	WMZT3C15
16	WMZT1C16	WMZT2C16	WMZT3C16
20	WMZT1C20	WMZT2C20	WMZT3C20
25	WMZT1C25	WMZT2C25	WMZT3C25
30	WMZT1C30	WMZT2C30	WMZT3C30
32	WMZT1C32	WMZT2C32	WMZT3C32
40	WMZT1C40	WMZT2C40	WMZT3C40

#### D Curve (10 – 20X I<sub>n</sub> Current Rating)

0.5	WMZT1DX0	WMZT2DX0	WMZT3DX0
1	WMZT1D01	WMZT2D01	WMZT3D01
1.5	WMZT1DX1	WMZT2DX1	WMZT3DX1
2	WMZT1D02	WMZT2D02	WMZT3D02
3	WMZT1D03	WMZT2D03	WMZT3D03
4	WMZT1D04	WMZT2D04	WMZT3D04
5	WMZT1D05	WMZT2D05	WMZT3D05
6	WMZT1D06	WMZT2D06	WMZT3D06
7	WMZT1D07	WMZT2D07	WMZT3D07
8	WMZT1D08	WMZT2D08	WMZT3D08
10	WMZT1D10	WMZT2D10	WMZT3D10
13	WMZT1D13	WMZT2D13	WMZT3D13
15	WMZT1D15	WMZT2D15	WMZT3D15
16	WMZT1D16	WMZT2D16	WMZT3D16
20	WMZT1D20	WMZT2D20	WMZT3D20
25	WMZT1D25	WMZT2D25	WMZT3D25
30	WMZT1D30	WMZT2D30	WMZT3D30
32	WMZT1D32	WMZT2D32	WMZT3D32
40	WMZT1D40	WMZT2D40	WMZT3D40

# UL 489 DIN Rail Miniature Circuit Breakers

## WMZT Circuit Breakers

### PRODUCT SELECTION

#### WMZT UL489 Circuit Breakers

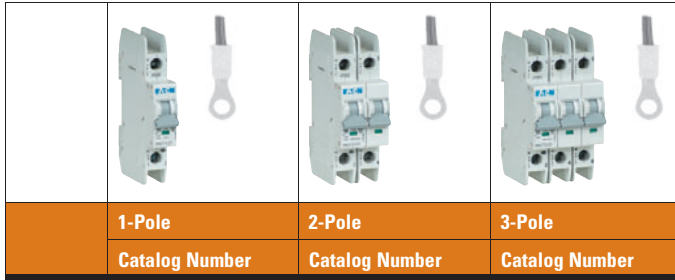

- UL approved (UL 489) and CSA Certified (CSA C22.2 No.5-02) as Branch Circuit Breakers
- Connections for ring-tongue terminals
- Interrupting capacity: 10 kA UL/CSA; 15 kA IEC 60947
- Current limiting device

#### C Curve with Ring-Tongue Terminals (5 – 10X $I_n$ Current Rating)

0.5	WMZT1CX0T	WMZT2CX0T	WMZT3CX0T
1	WMZT1C01T	WMZT2C01T	WMZT3C01T
1.5	WMZT1CX1T	WMZT2CX1T	WMZT3CX1T
2	WMZT1C02T	WMZT2C02T	WMZT3C02T
3	WMZT1C03T	WMZT2C03T	WMZT3C03T
4	WMZT1C04T	WMZT2C04T	WMZT3C04T
5	WMZT1C05T	WMZT2C05T	WMZT3C05T
6	WMZT1C06T	WMZT2C06T	WMZT3C06T
7	WMZT1C07T	WMZT2C07T	WMZT3C07T
8	WMZT1C08T	WMZT2C08T	WMZT3C08T
10	WMZT1C10T	WMZT2C10T	WMZT3C10T
13	WMZT1C13T	WMZT2C13T	WMZT3C13T
15	WMZT1C15T	WMZT2C15T	WMZT3C15T
16	WMZT1C16T	WMZT2C16T	WMZT3C16T
20	WMZT1C20T	WMZT2C20T	WMZT3C20T
25	WMZT1C25T	WMZT2C25T	WMZT3C25T
30	WMZT1C30T	WMZT2C30T	WMZT3C30T
32	WMZT1C32T	WMZT2C32T	WMZT3C32T
40	WMZT1C40T	WMZT2C40T	WMZT3C40T

#### D Curve with Ring-Tongue Terminals (10 – 20X $I_n$ Current Rating)

0.5	WMZT1DX0T	WMZT2DX0T	WMZT3DX0T
1	WMZT1D01T	WMZT2D01T	WMZT3D01T
1.5	WMZT1DX1T	WMZT2DX1T	WMZT3DX1T
2	WMZT1D02T	WMZT2D02T	WMZT3D02T
3	WMZT1D03T	WMZT2D03T	WMZT3D03T
4	WMZT1D04T	WMZT2D04T	WMZT3D04T
5	WMZT1D05T	WMZT2D05T	WMZT3D05T
6	WMZT1D06T	WMZT2D06T	WMZT3D06T
7	WMZT1D07T	WMZT2D07T	WMZT3D07T
8	WMZT1D08T	WMZT2D08T	WMZT3D08T
10	WMZT1D10T	WMZT2D10T	WMZT3D10T
13	WMZT1D13T	WMZT2D13T	WMZT3D13T
15	WMZT1D15T	WMZT2D15T	WMZT3D15T
16	WMZT1D16T	WMZT2D16T	WMZT3D16T
20	WMZT1D20T	WMZT2D20T	WMZT3D20T
25	WMZT1D25T	WMZT2D25T	WMZT3D25T
30	WMZT1D30T	WMZT2D30T	WMZT3D30T
32	WMZT1D32T	WMZT2D32T	WMZT3D32T
40	WMZT1D40T	WMZT2D40T	WMZT3D40T

# UL 489 DIN Rail Miniature Circuit Breakers

## WMZT Circuit Breakers

### ACCESSORIES

#### WMZT UL 489 Breakers

Accessory / Description	Catalog Number
2-Pole Contact or Auxiliary Contact/Trip Indicating Contact	<b>WMZSAUXTRIP</b>
Auxiliary Contact	<b>WMZTAUX</b>
Shunt Trip 110 – 415 Vac Shunt Trip 12 – 110 Vac	<b>WMZTST415</b> <b>WMZTST110</b>
Padlock Hasp	<b>WMZPLK</b>
Bus Bar — 1-Pole 6 Terminals Bus Bar — 1-Pole 12 Terminals Bus Bar — 1-Pole 18 Terminals Bus Bar — 2-Pole 6 Terminals Bus Bar — 2-Pole 12 Terminals Bus Bar — 2-Pole 18 Terminals Bus Bar — 3-Pole 6 Terminals Bus Bar — 3-Pole 12 Terminals Bus Bar — 3-Pole 18 Terminals	<b>WMZT1P6T</b> <b>WMZT1P12T</b> <b>WMZT1P18T</b> <b>WMZT2P6T</b> <b>WMZT2P12T</b> <b>WMZT2P18T</b> <b>WMZT3P6T</b> <b>WMZT3P12T</b> <b>WMZT3P18T</b>
3-Pole Bus Bar Shroud	<b>WMZT3PSHROUD</b>
Extension Terminal — 35 mm (2 – 14 AWG)	<b>WMZT35EXT</b>
Bus Connector — Conductors up to 50 mm <sup>2</sup> (~1/0 AWG)	<b>WMZTBCON</b> ①

① Contact sales office for availability.

#### Tripping Signal Switch WMZSAUXTRIP, WMZTAUX

- Design according to IEC/EN 60947-5-1, IEC/EN 62019
- Field installable
- The specified minimum voltages are per contact — take into account particularly in case of series connection
- Self-cleaning contacts
- Contact material and design particularly suitable for extra low voltage
- WMZSAUXTRIP: the function of one of the two change-over contacts can be switched from “auxiliary switch” to “tripping signal switch”
- WMZTAUX: will allow for > 480Y/277 Vac rating
- Tripping signal contact transmits message of electric tripping, not mechanical switch-off
- Test key for contact function “electrical tripping”

#### Connection Diagram

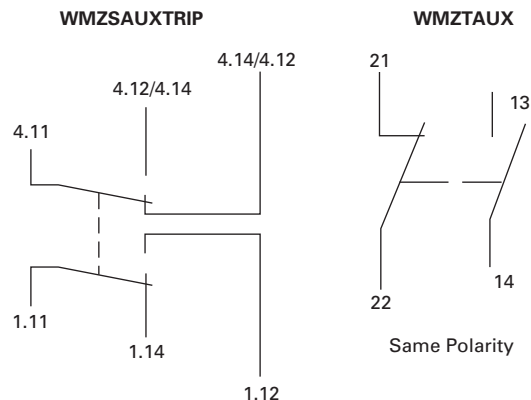

# UL 489 DIN Rail Miniature Circuit Breakers

WMZT Circuit Breakers

ACCESSORIES

## Accessories

Description	WMZSAUXTRIP	WMZTAUX
<b>Electrical</b>		
Can be Mounted from the Left Onto		
Contact Function	2C0	1NO + 1NC
Rated Voltage	230V	250V
Frequency	50/60 Hz	50/60 Hz
Rated Current	2A	6A
Rated Thermal Current $I_{th}$	2A	6A
Utilization Category AC13 Rated Operational Current $I_o$	3A / 250 Vac	3A / 250 Vac
Utilization Category AC15 Rated Operational Current $I_o$	2A / 250 Vac	2A / 250 Vac
Utilization Category DC12 Rated Operational Current $I_o$	0.5A / 110 Vdc	0.5A / 110 Vdc 0.25A / 220 Vdc
Rated Insulation Voltage $U_i$	250 Vac	250 Vac
Minimum Operational Voltage per Contact $U_{min}$	5 Vdc	5 Vdc
Minimum Operational Current $I_{min}$	10 mA dc	10 mA ac/dc
Rated Peak Withstand Voltage $U_{imp}$ (1.2/50 $\mu$ )	2.5 kV	4 kV
Conditional Short Circuit Current $I_k$ with Back-Up Fuse 6A	1 kA	1 kA
Max. Back-Up Fuse, Overload and Short Circuit	6A gL	—

## Mechanical

Tripping Indicator "Electrical Tripping"	Blue / White	—
Frame Size	45 mm	45 mm
Device Height	80 mm	80 mm
Device Width	8.8 mm (0.5MU)	8.8 mm (0.5MU)
Mounting	Onto Switching Dev.	—
Degree of Protection, Built-In	IP40	IP40
Terminal Protection	Finger and Hand Touch Safe According to BGV A3, ÖVE-EN 6	Finger and Hand Touch Safe According to BGV A3, ÖVE-EN 6
Terminals	Lift Terminals	Lift Terminals
Terminal Capacity	20 – 14 AWG	0.5 – 2.5 mm <sup>2</sup>
Terminal Screws	M3 (Pozidrive Z0)	M3 (Pozidrive Z0)
Fastening Torque of Terminal Screws	7 lb-in	Max. 1.2 Nm

The Voltage of the WMZT... Circuit Breaker is Limited to 300 V with this Auxiliary Switch Installed.

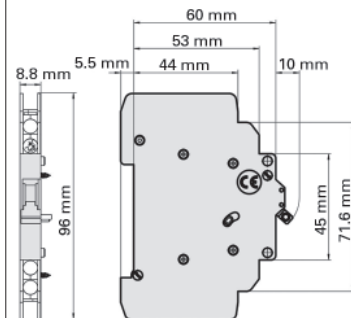
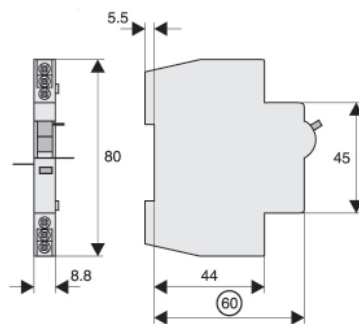

# UL 489 DIN Rail Miniature Circuit Breakers

## WMZT Circuit Breakers

### ACCESSORIES

#### Shunt Trip Release WMZTST

- Remote release for subsequent mounting onto WMZT
- Additional installation of standard auxiliary switch is possible
- Position indicator red – green

#### Connection Diagram

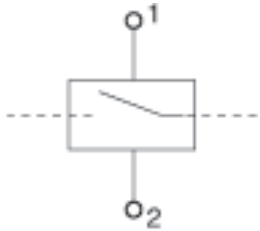

#### Shunt Trip Release WMZTST

Description	WMZTST110	WMZTST415
-------------	-----------	-----------

#### Electrical

Can be Mounted Onto	WMZT	WMZT
Operational Voltage Range	12 – 110 Vac 12 – 60 Vdc	110 – 415 Vac 110 – 230 Vdc
Frequency	50/60 Hz	50/60 Hz

#### Mechanical

Frame Size	45 mm	45 mm
Device Height	105 mm	105 mm
Device Width	17.5 mm	17.5 mm
Mounting	Quick Fastening with 2 Lock-In Positions on EN 50022	
Degree of Protection, Built-In	IP40	IP40
Terminal Protection	Finger and Hand Touch Safe According to BGV A3, ÖVE-EN 6	
Terminals	Open Mouthed / Lift	Open Mouthed / Lift
Terminal Capacity 1 and 2 Wires	18 – 10 AWG	18 – 10 AWG

#### Bus Bar Block UL489 (Pin)

- Tested according to UL 489
- Do not cut
- Extension terminal 35 mm<sup>2</sup> WMZT35EXT for copper conductors
- For covering of not used pins use bus bar tag shrouds WMZT3PSHROUD

#### Connection Diagram

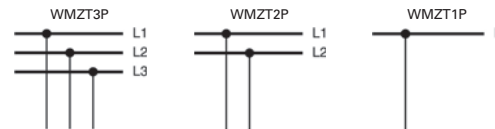

#### Bus Bar Block UL489 (Pin)

Description	UL489	IEC/EN60947-2
-------------	-------	---------------

#### Electrical

Rated Operational Voltage	480/277 Vac 96 Vdc	—
Rated Frequency	50/60 Hz	—
Rated Voltage	—	690V ac
Overvoltage Category	—	III
Rated Impulse Withstand Voltage U <sub>imp</sub>	—	9.5 kV
Rated Current	80A	80A
Rated Conditional Short-Circuit Current AC with 350A gG	—	15 kA
Short-Circuit Current	10 kA	—

#### Mechanical

Bus Bar Cross Section	—	16 mm <sup>2</sup> Cu
Flame Class acc. to UL 94	V0	—
Pollution Degree	—	2
Comparative Tracking Index	—	CTI 600
Minimum Clearance (intern / extern)	—	> 9.5/25.4 mm
Minimum Creepage Distance (intern / extern)	—	> 12.7/50.8 mm
Resistance to Climatic Conditions	—	Acc. to DIN/EN60068



# UL 489 DIN Rail Miniature Circuit Breakers

WMZT Circuit Breakers

ACCESSORIES

## Dimensions (mm)

WMZT\_\_6T

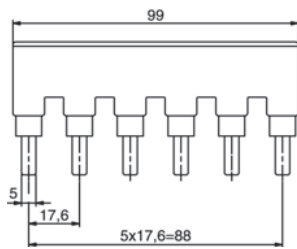

WMZT\_\_12T

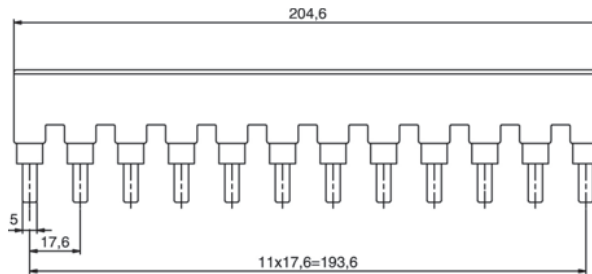

WMZT3PSHROUD

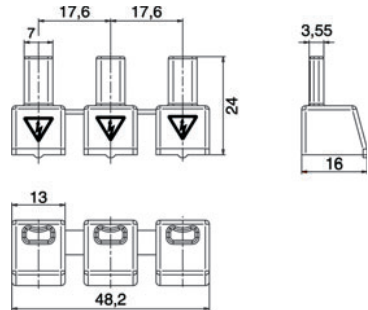

WMZT\_\_18T

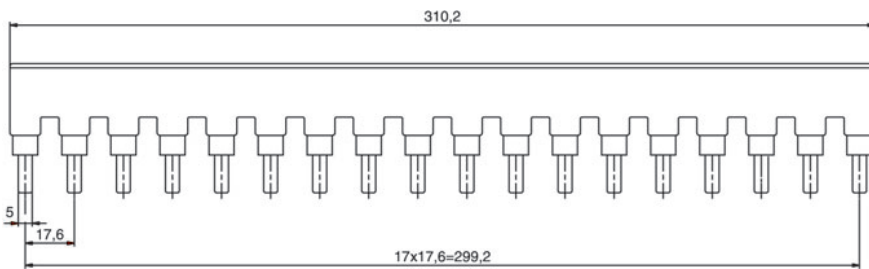

WMZT35EXT

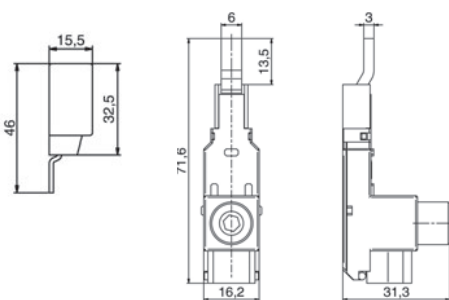

## Bus Bar Connection Example

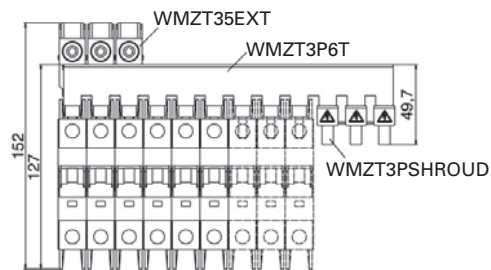

## Lockout Attachment

WMZPLK

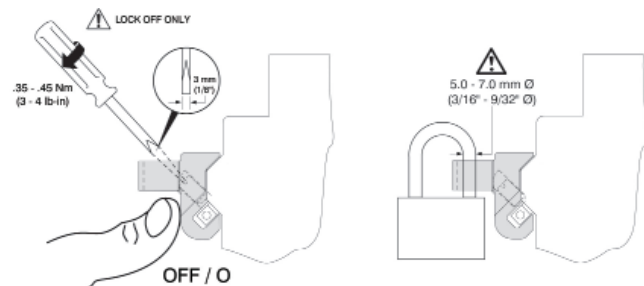

WMZT35EXT

Description	UL489	IEC/EN60947-2
	# 2 – 14 AWG 60/75°C Cu	2.5 – 35 mm <sup>2</sup> Cu
	0.56 in	14 mm
Tested acc. to		Tightening Torque of Terminal Screws
UL 486A	# 14 AWG	≥ 2.3 Nm
UL 486B	# 8 – 12 AWG	≥ 2.8 Nm
UL 486E	# 6 – 1 AWG	4 Nm

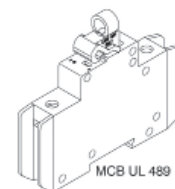

Accessories

# UL 489 DIN Rail Miniature Circuit Breakers

## WMZT Circuit Breakers

### TECHNICAL DATA

#### Miniature Circuit Breakers WMZT

##### Connection Diagrams

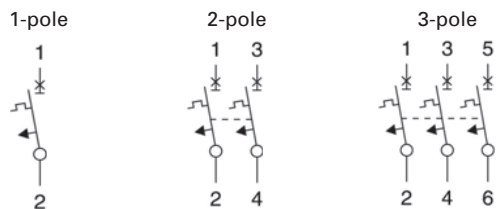

##### Dimensions (mm)

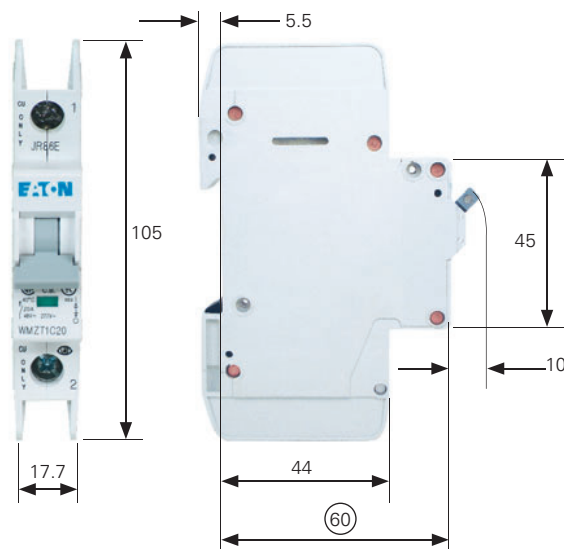

#### Miniature Circuit Breaker WMZT

Description	
-------------	--

##### Electrical

Design According to	UL 489, CSA C22.2 No.5, IEC 60947-2
Rated Voltage	UL/CSA 0.5 – 25A 277/480Y Vac UL/CSA 32 – 40A 240 Vac UL/CSA (per pole) 48 Vdc IEC 240/415 Vac
Rated Frequency	50/60 Hz
Rated Breaking Capacity	UL/CSA 10 kA IEC 15 kA
Characteristic	C, D
Endurance	≥ 20,000 Operations
Line Voltage Connection	Optional Suitable for Reverse Feed

##### Mechanical

Frame Size	45 mm	
Device Height	105 mm	
Device Width	17.7 mm per pole	
Mounting	Quick Fastening with 2 Lock-In Positions on IEC/EN 60715	
Upper and Lower Terminals	Open Mouth/Lift Terminals	
Terminal Capacity	1 Wire 2 Wires	AWG 18 – 6 AWG 18 – 10
Terminal Fastening Torque	AWG 18-21: 21 lb-in AWG 10-8: 25 lb-in AWG 6: 36 lb-in	
Mounting	Independent of Position	
Calibration temperature	UL 489, CSA C22.2 No.5 40°C IEC 60947-2 30°C	

##### Power loss at $I_n$

$I_n$ [A]	Characteristic C			Characteristic D		
	1p	2p	3p	1p	2p	3p
	P [W]	P [W]	P [W]	P [W]	P [W]	P [W]
0.5	1.6	3.2	4.7	1.6	3.2	4.8
1	1.1	2.2	3.4	0.8	1.5	2.3
1.5	1.3	2.6	3.9	1.0	2.1	3.1
2	1.4	2.8	4.3	1.0	2.1	3.1
3	1.2	2.4	3.6	1.2	2.4	3.6
4	1.4	2.9	4.3	1.4	2.9	4.3
5	1.9	3.7	5.6	1.5	2.9	4.4
6	1.2	2.3	3.5	1.2	2.3	3.5
7	1.4	2.8	4.3	1.4	2.8	4.3
8	1.4	2.8	4.2	1.2	2.4	3.7
10	1.8	3.6	5.3	1.5	3.0	4.5
13	2.4	4.7	7.1	2.0	4.1	6.1
15	1.9	3.8	5.6	1.5	3.1	4.6
16	2.1	4.3	6.4	1.7	3.5	5.2
20	2.9	5.8	8.7	1.8	3.7	5.5
25	3.1	6.2	9.3	2.6	5.1	7.7
30	3.0	6.0	9.0	2.7	5.4	8.1
32	3.4	6.8	10.2	3.1	6.2	9.3
35	3.7	7.4	11.0	3.8	7.6	11.3
40	4.0	8.1	12.1	3.9	7.8	11.6

# UL 489 DIN Rail Miniature Circuit Breakers

WMZT Circuit Breakers

TECHNICAL DATA

## Let-Through Energy

Characteristic C (0.5 – 20A), 277V

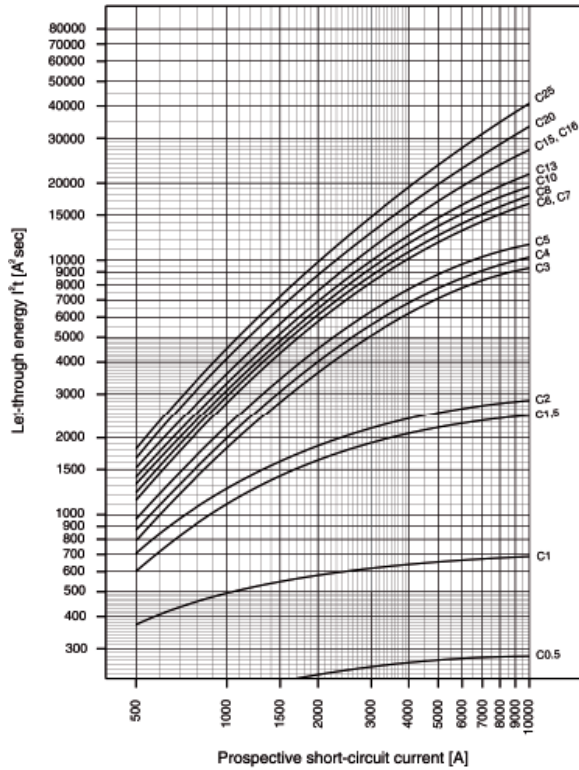

Characteristic C (25 – 40A), 240V

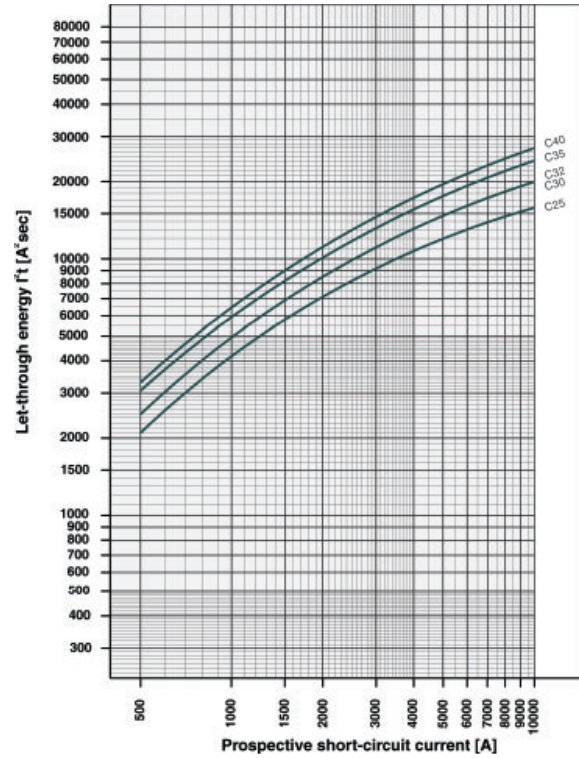

Characteristic D (0.5 – 20A), 277V

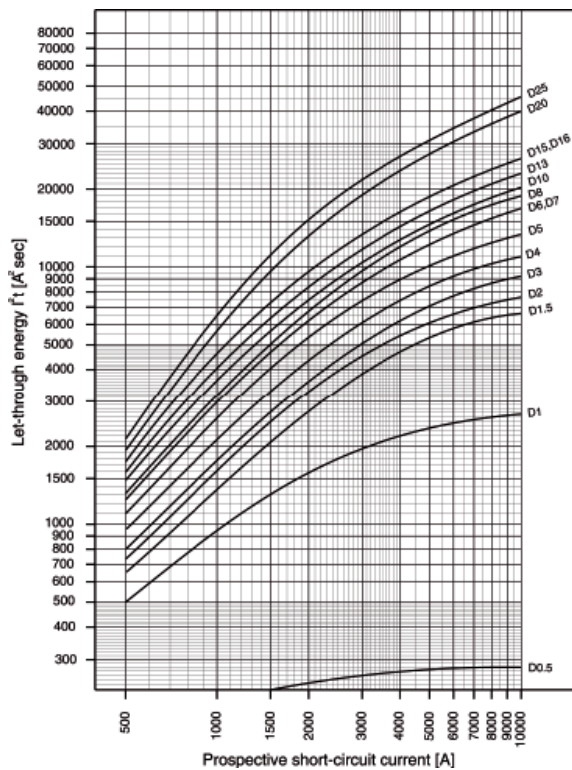

Characteristic D (25 – 40A), 240V

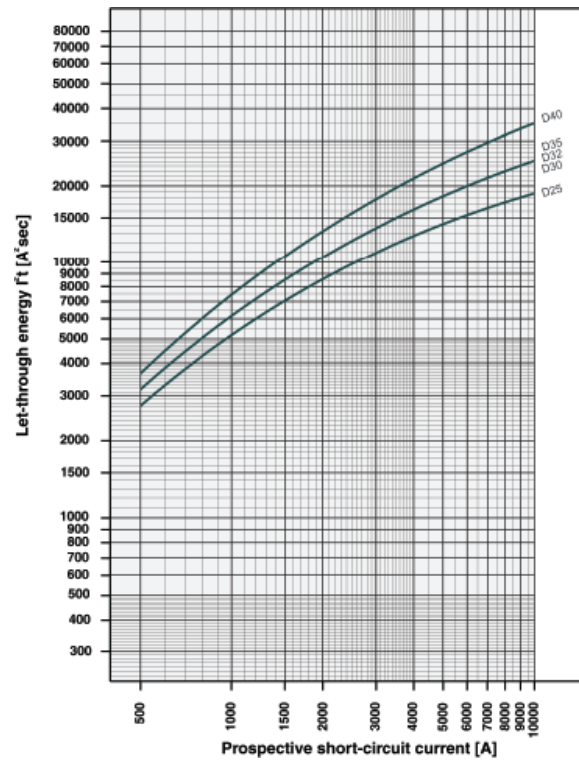

# UL 489 DIN Rail Miniature Circuit Breakers

## WMZT Circuit Breakers

### TECHNICAL DATA

#### Lockout Attachment

Device Market Current Rating in (A) @ 40°C	I <sub>n</sub> (A) at Higher Ambient Temperature							
	15°C	20°C	25°C	30°C	40°C	50°C	55°C	60°C
0.5	0.6	0.5	0.5	0.5	0.5	0.5	0.5	0.5
1.0	1.1	1.1	1.1	1.0	1.0	1.0	0.9	0.9
1.5	1.7	1.6	1.6	1.6	1.5	1.4	1.4	1.4
2.0	2.2	2.2	2.1	2.1	2.0	1.9	1.9	1.8
3.0	3.3	3.2	3.2	3.1	3.0	2.9	2.9	2.8
4.0	4.4	4.3	4.2	4.2	4.0	3.8	3.8	3.7
5.0	5.5	5.4	5.3	5.2	5.0	4.8	4.7	4.6
6.0	6.6	6.5	6.4	6.2	6.0	5.8	5.6	5.5
7.0	7.7	7.6	7.4	7.3	7.0	6.7	6.6	6.4
8.0	8.8	8.6	8.5	8.3	8.0	7.7	7.5	7.4
10.0	11.0	10.8	10.6	10.4	10.0	9.6	9.4	9.2
13.0	14.3	14.0	13.8	13.5	13.0	12.5	12.5	12.0
15.0	16.5	16.2	15.9	15.6	15.0	14.4	14.1	13.8
16.0	17.6	17.3	17.0	16.6	16.0	15.4	15.0	14.7
20.0	22.0	21.6	21.2	20.8	20.0	19.2	18.8	18.4
25.0	27.5	27.0	26.5	26.0	25.0	24.0	23.3	23.0
30.0	33.0	32.4	31.8	31.2	30.0	28.8	28.2	27.6
32.0	35.2	34.6	33.9	33.3	32.0	30.7	30.1	29.4
40.0	44.0	43.2	42.4	41.6	40.0	38.4	37.6	36.8

#### Influence of Ambient Temperature T on Load Carrying Capacity

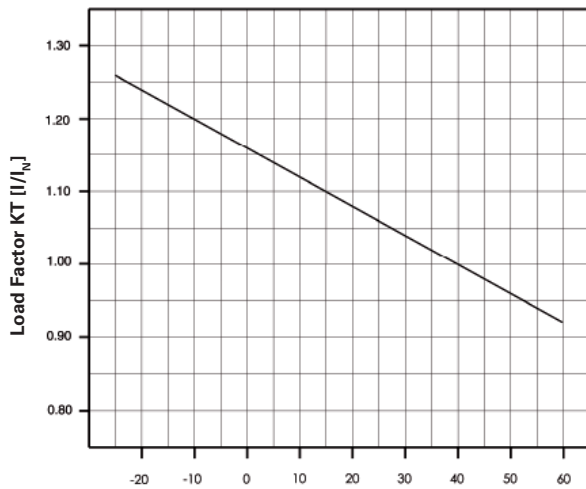

Maximum Load  $I_L$  at ambient temperature T:  $I_L(T) = I_N K_T(T)$