

LITHIUM - Coin Type

Coin type lithium batteries are high energy, high reliability batteries for a variety of applications. The full 3 volts in these high energy density batteries is about twice that of conventional dry batteries.

Panasonic coin type lithium batteries are available in two types: poly-carbonmonofluoride lithium batteries (BR series) for uses that require extended reliability and safety, and manganese dioxide lithium batteries (CR series) for uses that require high voltage and strong load pulse characteristics.



The CR Lithium primary coin cells contain Perchlorate over the limit specified by the state legislature of California and are therefore subject to requirements in the California Code of Regulations, title 22, division 4.5: Chapter 33 – Best Management Practices for Perchlorate Materials.

Features:

- High voltage of 3 volts - twice that of conventional dry batteries
- Extremely small self-discharge for long service and shelf life
- A wide operational temperature range
- Compact and lightweight; extremely high energy density per unit weight
- Very safe (poly-carbonmonofluoride lithium)
- Extremely strong load pulse characteristics (manganese dioxide lithium)
- Operating temperature range:
 - BR Coin Cells: -30°C ~ +80°C
 - CR Coin Cells: -30°C ~ +60°C

Applications:

- Calculators
- Cameras
- Compact, low power consuming cordless applications
- Electronic translators
- Electronic watches (digital and analog)
- Memory back-up in all types of devices (with tab terminals)

Technical Data - Table 1 - (CF)n/LI: Poly-Carbon Monofluoride (BR)

Model No.	Electrical Characteristics (20°C)		Standard Load	Dimensions			Tab Configurations
	Nominal Voltage (V)	*Nominal Capacity (mAh)	Continuous Drain (mA)	Diameter (mm)	Height (mm)	Weight (g)	
BR1220	3	35	0.03	12.5	2.00	0.7	
BR1225	3	48	0.03	12.5	2.50	0.8	
BR1632	3	120	0.03	16.0	3.20	1.5	
BR2032	3	190	0.03	20.0	3.20	2.5	
BR2325	3	165	0.03	23.0	2.50	3.2	
BR2330	3	255	0.03	23.0	3.00	3.2	
BR3032	3	500	0.03	30.0	3.20	5.5	

* Nominal capacity shown is based on standard drain and cut off voltage down to 2.0V at 20°C.

Technical Data - Table 2 - MnO₂/LI:Manganese Dioxide (CR)

Model No.	Electrical Characteristics (20°C)		Standard Load	Dimensions			Tab Configurations
	Nominal Voltage (V)	*Nominal Capacity (mAh)	Continuous Drain (mA)	Diameter (mm)	Height (mm)	Weight (g)	
CR1025	3	30	0.10	10.0	2.50	0.7	
CR1216	3	25	0.10	12.5	1.60	0.7	

CR1220	3	35	0.10	12.5	2.00	1.2	
CR1612	3	40	0.10	16.0	1.20	0.8	
CR1616	3	55	0.10	16.0	1.60	1.2	
CR1620	3	75	0.10	16.0	2.00	1.3	
CR1632	3	140	0.10	16.0	3.20	1.8	
CR2016	3	90	0.10	20.0	1.60	1.6	
CR2025	3	165	0.20	20.0	2.50	2.3	
CR2032	3	225	0.20	20.0	3.20	2.9	
CR2330	3	265	0.20	23.0	3.00	3.8	
CR2354	3	560	0.20	23.0	5.40	5.8	
CR2412	3	100	0.20	24.5	1.20	2.0	
CR2450	3	620	0.20	24.5	5.00	6.3	
CR2477	3	1000	0.20	24.5	7.70	10.5	
CR3032	3	500	0.20	30.0	3.20	6.8	

* Nominal capacity shown is based on standard drain and cut off voltage down to 2.0V at 20°C.

Note: Cells are available in assorted tab configurations.

Consult your local regional office for additional information.

Technical Data - Table 3 - Coin Cell Tab Configurations (BR Series)

Model No.	Tab Description Drawing	
BR1225/IHC	2 pin, horizontal mount, through hole, (with insulation wrap)	
BR1225/IVC	2 pin, vertical mount, through hole, (with insulation wrap)	
BR1632/IHF	2 pin, horizontal mount, through hole, (with insulation wrap)	
BR2032/IGU	3 pin, horizontal mount, through hole, (without insulation wrap)	
BR2032/IHE	2 pin, horizontal mount, through hole, (without insulation wrap)	
BR2032/IVB	2 pin, vertical mount, through hole, (without insulation wrap)	
BR2032/IF2	2 pin, flat mount, (with insulation wrap)	
BR2325/IHC	2 pin, horizontal mount, through hole, (with insulation wrap)	
BR2325/IHB	2 pin, horizontal mount, through hole, (without insulation wrap)	
BR2325/IVC	2 pin, vertical mount, through hole, (without insulation wrap)	
BR2325/IHG	2 pin, horizontal mount, through hole, (without insulation wrap)	
BR2325/IVG	2 pin, vertical mount, through hole, (without insulation wrap)	
BR2330/IHE	2 pin, horizontal mount, through hole, (without insulation wrap)	
BR2330/IVC	2 pin, vertical mount, through hole, (with insulation wrap)	
BR2330/IGVF	3 pin, vertical mount, through hole, (with insulation wrap)	

Manganese Dioxide Lithium Coin Batteries: Individual Specifications

CR1220

■ Dimensions(mm)

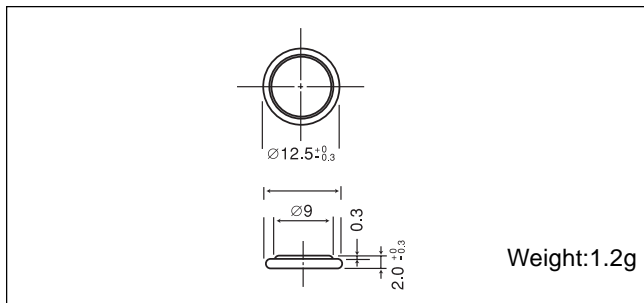

■ Specification

Nominal voltage (V)	3
Nominal capacity (mAh)	35
Continuous standard load (mA)	0.1
Operating temperature (C)	-30 ~ +60

■ Temperature Characteristics



■ Operating voltage vs. load resistance (voltage at 50% discharge depth)



■ Capacity vs. load resistance



CR1612

■ Dimensions(mm)

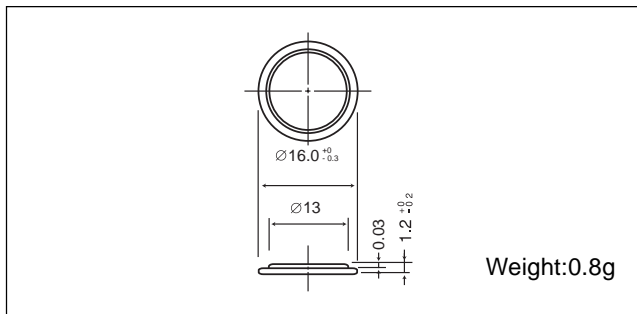

■ Specification

Nominal voltage (V)	3
Nominal capacity (mAh)	40
Continuous standard load (mA)	0.1
Operating temperature (C)	-30 ~ +60

■ Temperature Characteristics

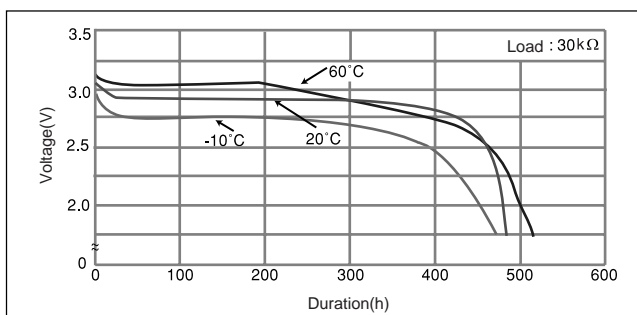

■ Operating voltage vs. load resistance (voltage at 50% discharge depth)

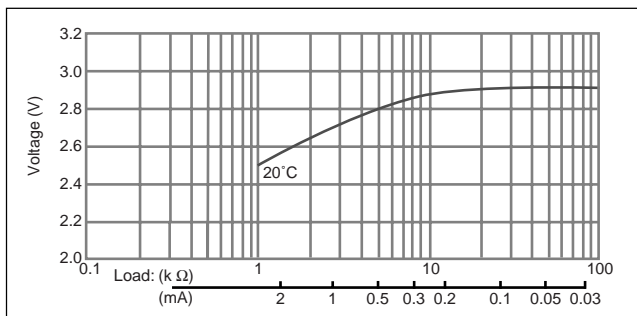

■ Capacity vs. load resistance

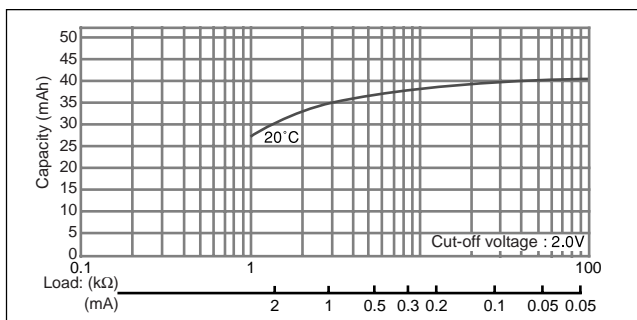

Coin Type Lithium Batteries

Manganese Dioxide Lithium Batteries (CR Series)



Features

As with the BR series of coin-type lithium batteries, these batteries feature a high energy density, and they were developed and commercialized via Panasonic's extensive experience and battery technology. These batteries have proven to be especially useful in equipment requiring relatively high currents.

Construction

Cutaway view

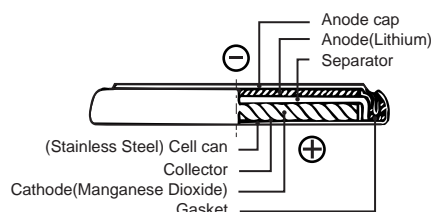

Applications

- Calculators
- Cameras
- Compact, low power consuming cordless appliances
- Electronic watches (digital and analog)
- Memory backup
- IC card



Note: Always confirm that the battery to be used is suitable for the intended application before purchase and/or use.

General Specifications

Model No.	Electrical Characteristics (20°C)			Dimensions (mm)		Weight (g)	JIS	IEC
	Nominal Voltage (V)	*Nominal Capacity (mAh)	Continuous Drain (mA)	Diameter	Height			
CR1025	3	30	0.1	10.0	2.5	0.7	CR1025	CR1025
CR1216	3	25	0.1	12.5	1.6	0.7	CR1216	CR1216
CR1220	3	35	0.1	12.5	2.0	1.2	CR1220	CR1220
CR1612	3	41	0.1	16.0	1.2	0.8	CR1620	-
CR1616	3	55	0.1	16.0	1.6	1.2	CR1616	CR1616
CR1620	3	75	0.1	16.0	2.0	1.3	-	CR1620
CR1632	3	140	0.1	16.0	3.2	1.8	-	-
CR2012	3	55	0.1	20.0	1.2	1.4	CR2012	CR2012
CR2016	3	90	0.1	20.0	1.6	1.6	CR2016	CR2016
CR2025	3	165	0.2	20.0	2.5	2.3	CR2025	CR2025
CR2032	3	225	0.2	20.0	3.2	2.9	CR2032	CR2032
CR2330	3	265	0.2	23.0	3.0	3.8	CR2330	CR2330
CR2354	3	560	0.2	23.0	5.4	5.8	CR2354	CR2354
CR2412	3	100	0.2	24.5	1.2	2.0	-	-
CR2450	3	620	0.2	24.5	5.0	6.3	CR2450	CR2450
CR2477	3	1000	0.2	24.5	7.7	10.5	-	-
CR3032	3	500	0.2	30.0	3.2	6.8	-	CR3032

* Nominal capacity shown above is based on standard drain and cut off voltage down to 2.0V at 20°C

Poly-carbonmonofluoride (BR Series) and Manganese Dioxide (CR Series)

COIN CELL TAB CONFIGURATIONS

Model Number	Tab Type		Configuration Diagram No.
	With Insulation Wrap	Without Insulation Wrap	
BR TYPE			
BR1220	/1HF	/1HE	1
BR1220	/1VC	/1VB	2
BR1225	/1HC	/1HB	3
BR1225	/1VC		4
BR1632	/1HF		5
BR2032	/1HM		6
BR2032		/1HG	7
BR2032	/1HS	/1HSE	8
BR2032	/1GUF	/1GU	9
BR2032	/1HF	/1HE	10
BR2032		/1VB	11
BR2032	/1GVF	/1GV	12
BR2032	/1F4		13
BR2032	/1F2		14
BR2325	/1HC	/1HB	15
BR2325	/1VC		16
BR2325		/1HG	17
BR2325	/2HC		18
BR2325		/1VG	19
BR2330	/1HF	/1HE	20
BR2330	/1GUF	/1GU	21
BR2330	/1VC	/1VB	22
BR2330	/1GVF	/1GV	23
BR2330	/1F3		24
BR2330	/1F4C		25
BR3032	/1VC		26
BR3032	/1F2		27

Model Number	Tab Type		Configuration Diagram No.
	With Insulation Wrap	Without Insulation Wrap	
CR TYPE			
CR1220	/1HF	/1HE	1
CR1220	/1VC	/1VB	2
CR1616		/1F2	28
CR1632	/1HF		29
CR2016	/1F2		6
CR2025	/1F2		30
CR2032		/1HU3	31
CR2032	/1VS1		32
CR2032		/1HG	8
CR2032	/1HS	/1HSE	9
CR2032	/1GUF	/1GU	10
CR2032	/1HF	/1HE	11
CR2032		/1VB	12
CR2032	/1GVF	/1GV	13
CR2032	/1F4		14
CR2032	/1F2		15
CR2330	/1HF	/1HE	20
CR2330	/1GUF	/1GU	21
CR2330	/1VC	/1VB	22
CR2330	/1GVF	/1GV	23
CR2330	/1F3		24
CR2330	/1F4C		25
CR2354	/1HF	/1HE	33
CR2354	/1GUF	/1GU	34
CR2354	/1VC	/1VB	35
CR2477	/1VC	/1VB	36
CR2477	/1HF	/1HE	37
CR2450	/H1A		38
CR2450	/G1A		39
CR3032	/1VC		26
CR3032	/1F2		27

Note: Refer to page 60 for BR "A" (High Temp) Tab configurations. Please contact Panasonic for requests on custom Tab configurations. Minimum order requirements may apply.