

AC Power Inlets IEC 320 - C14

Max Rating: UL & CSA 15A/250VAC - VDE 10A/250VAC

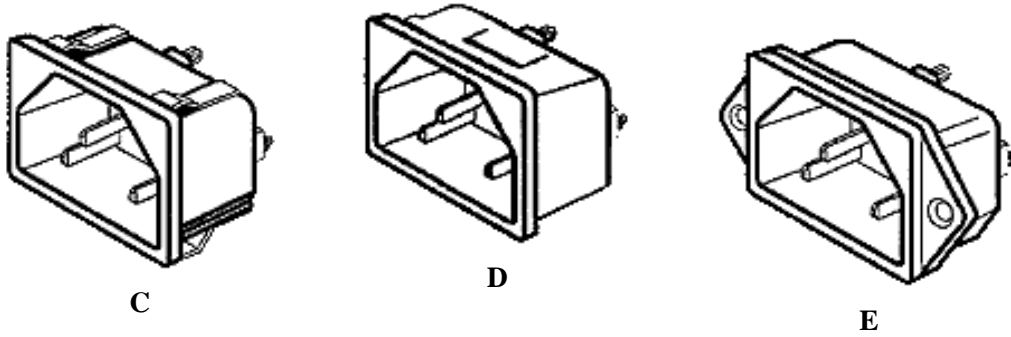
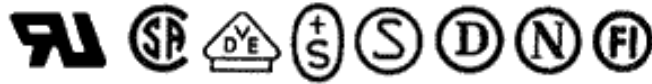

Male power inlets includes snap-in and screw mount types with solder tab, .187 Q.D. and .250 Q.D.

Part Number	PDF Drawings	Description	Terminals	Figure
701W-X2/02*		Snap-In Mount	Solder Tab	C
701W-X2/03*		Snap-In Mount	.187 Q.D. / Solder	C
701W-X2/04*		Snap-In Mount	.250 Q.D.	C
701W-15/21**		Snap-In Mount	Solder Tab	D
701W-15/26**		Snap-In Mount	.187 Q.D. / Solder	D
701W-15/31**		Snap-In Mount	.250 Q.D.	D
703W-00/06		Screw Mount	Solder Tab	E
703W-00/07		Screw Mount	.187 Q.D. / Solder	E

703W-00/08		Screw Mount	.250 Q.D.	E
------------	---	-------------	-----------	---



* Universal snap-in feature to fit 0.8 mm - 2.0 mm panel thickness

** Panel Thickness 1.5 mm (1.0, 2.0, and 3.0 are also available)



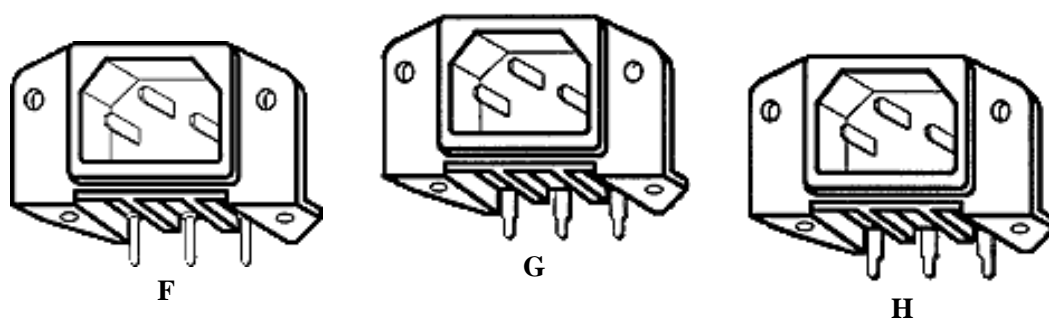
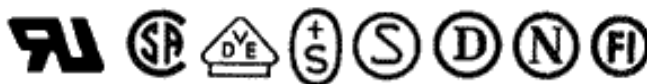

Angled Inlet PCB Mount IEC 320 - C14

Max Rating: UL & CSA 15A/250VAC - VDE 10A/250VAC



Male right angled PCB mount power inlet offered with 7 mm or 9 mm terminal centers with 40 mm mounting centers.

Part Number	PDF Drawings	Description	Terminals Pitch	Figure
703W-00/52*		PCB Mount	7 mm	F
703W-00/53**		PCB Mount	7 mm	G
703W-00/54**		PCB Mount	9 mm	H

* Round PCB Pins

** Flat PCB Pins

