

## 32/35 SERIES

- PRESSFIT INDICATOR LIGHTS
- NEON, LED & INCANDESCENT
- 2 TO 600 DESIGN VOLTS
- 6" WIRE LEADS & 3/16" TAB TERMINALS
- VARIETY OF LENS COLORS
- UL AND CSA LISTED • UL FILE E20356
- CSA FILE LR15284-5

### Overview

The 32/35 Series Indicators feature a wide variety of lenses, colors, voltage & bezel variations. Indicators quickly pressfit into a 0.500" to 0.510" mounting hole with recommended panel thickness range of 0.020" min. to 0.090" max. A speednut, part number **8700071674**, and Adapters for 0.514" to 0.519" are available.

### Specifications

**Housing:** white nylon. A black housing is available.

**Bezel:** nickel plated brass. A black anodized bezel is available.

**Lens:** polycarbonate.

**Incandescent AC or DC voltage options:** 6, 14 and 28 volts.

**Neon AC or DC voltage options:** 125, 250 and 600 volts. **Note:** high brightness green and blue neon lamps supplied in green and blue neon applications.

**LED DC voltage options:** 2, 6, 12, 24 volts.

**LED AC voltage options:** 125 volts.

**Note:** 125 volts AC units contain a bi-polar LED.

**Two 6" wire leads:** #20 AWG, black, bare copper, PVC insulated, UL/CSA rated 105°C, 600 V, UL style 1015, stripped 1/2". For DC LED units, wire leads are color-coded red and black; the red wire lead denotes the anode (+) while a black wire lead identifies the cathode (-). For AC LED units, wire leads are white. Custom wire lengths, stripping, termination and wire types are available.

#### Terminals:

**3/16" tabs:** brass, (0.187" length x 0.020" thick). For LED units, a tin plated terminal denotes the anode (+). 1/4" or 1/8" brass tab terminals are available.

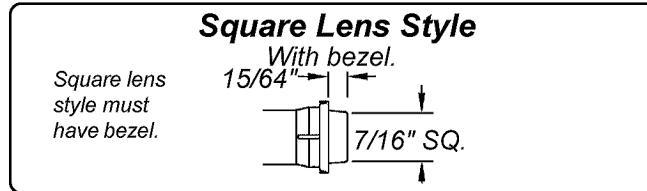
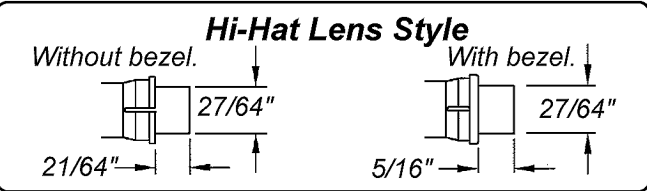
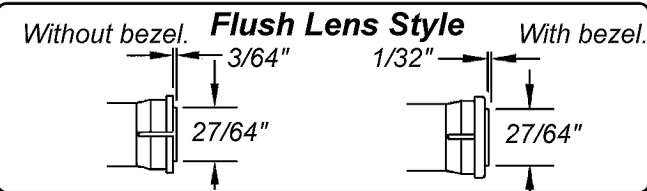
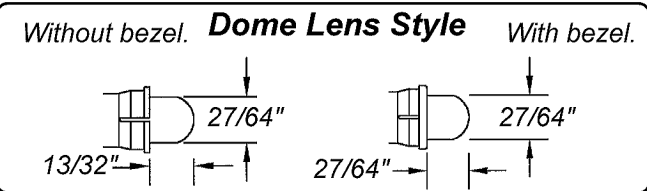
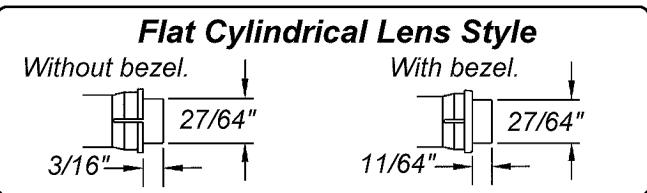
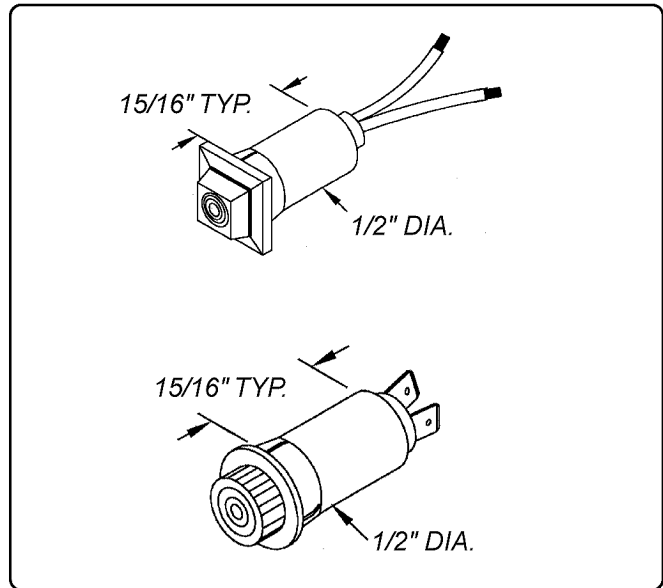

**32/35 Series  
Flat Cylindrical Lens  
Nickel Plated Bezel  
Neon or  
Incandescent**

**Flat Cylindrical Lens Style**  
With bezel.

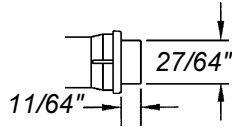

**6" Wire Leads or  
3/16" Tab Terminals  
White Housing  
6 to 250 Design Volts  
PressFit Mounting**

| Part Number<br>6" Wire Leads | Part Number<br>3/16" Tab Terminals | Lens Color | Lamp Type    | Design Volts | Design Watts<br>or Amps | Life (hrs) |
|------------------------------|------------------------------------|------------|--------------|--------------|-------------------------|------------|
| 32R-2111                     | 32R-2111T                          | Red        | Neon         | 125          | 1/3W                    | 25,000     |
| 35R-2111                     | 35R-2111T                          | Red        | Neon         | 250          | 1/3W                    | 25,000     |
| 32RG1-2111                   | 32RG1-2111T                        | Red        | Incandescent | 6            | .20A                    | 5,000      |
| 32RG3-2111                   | 32RG3-2111T                        | Red        | Incandescent | 14           | .10A                    | 10,000     |
| 32RG18-2111                  | 32RG18-2111T                       | Red        | Incandescent | 28           | .04A                    | 7,000      |
| 32R-2112                     | 32R-2112T                          | Green      | Neon         | 125          | 1/3W                    | 25,000     |
| 35R-2112                     | 35R-2112T                          | Green      | Neon         | 250          | 1/3W                    | 25,000     |
| 32RG1-2112                   | 32RG1-2112T                        | Green      | Incandescent | 6            | .20A                    | 5,000      |
| 32RG3-2112                   | 32RG3-2112T                        | Green      | Incandescent | 14           | .10A                    | 10,000     |
| 32RG18-2112                  | 32RG18-2112T                       | Green      | Incandescent | 28           | .04A                    | 7,000      |
| 32R-2113                     | 32R-2113T                          | Amber      | Neon         | 125          | 1/3W                    | 25,000     |
| 35R-2113                     | 35R-2113T                          | Amber      | Neon         | 250          | 1/3W                    | 25,000     |
| 32RG1-2113                   | 32RG1-2113T                        | Amber      | Incandescent | 6            | .20A                    | 5,000      |
| 32RG3-2113                   | 32RG3-2113T                        | Amber      | Incandescent | 14           | .10A                    | 10,000     |
| 32RG18-2113                  | 32RG18-2113T                       | Amber      | Incandescent | 28           | .04A                    | 7,000      |
| 32R-2114                     | 32R-2114T                          | Blue       | Neon         | 125          | 1/3W                    | 25,000     |
| 35R-2114                     | 35R-2114T                          | Blue       | Neon         | 250          | 1/3W                    | 25,000     |
| 32RG1-2114                   | 32RG1-2114T                        | Blue       | Incandescent | 6            | .20A                    | 5,000      |
| 32RG3-2114                   | 32RG3-2114T                        | Blue       | Incandescent | 14           | .10A                    | 10,000     |
| 32RG18-2114                  | 32RG18-2114T                       | Blue       | Incandescent | 28           | .04A                    | 7,000      |
| 32R-2115                     | 32R-2115T                          | White      | Neon         | 125          | 1/3W                    | 25,000     |
| 35R-2115                     | 35R-2115T                          | White      | Neon         | 250          | 1/3W                    | 25,000     |
| 32RG1-2115                   | 32RG1-2115T                        | White      | Incandescent | 6            | .20A                    | 5,000      |
| 32RG3-2115                   | 32RG3-2115T                        | White      | Incandescent | 14           | .10A                    | 10,000     |
| 32RG18-2115                  | 32RG18-2115T                       | White      | Incandescent | 28           | .04A                    | 7,000      |
| 32R-2117                     | 32R-2117T                          | Clear      | Neon         | 125          | 1/3W                    | 25,000     |
| 35R-2117                     | 35R-2117T                          | Clear      | Neon         | 250          | 1/3W                    | 25,000     |
| 32RG1-2117                   | 32RG1-2117T                        | Clear      | Incandescent | 6            | .20A                    | 5,000      |
| 32RG3-2117                   | 32RG3-2117T                        | Clear      | Incandescent | 14           | .10A                    | 10,000     |
| 32RG18-2117                  | 32RG18-2117T                       | Clear      | Incandescent | 28           | .04A                    | 7,000      |

Indicator Lights