

Compact Limit Switch That's Also Thin and Highly Sealed



- Approved by EN, UL, CSA, and CCC (Chinese standard).
(Ask your OMRON representative for information on approved models.)
- Sealing characteristics that meet IEC IP67 degree of protection.
- Triple-sealed construction:
Plunger section sealed via nitrile rubber packing seal and diaphragm; switch section sealed via nitrile rubber cap; cable entrance sealed via encapsulating material.
- Cable lengths of 3 and 5 m available on standard models.
Models also available with UL and CSA-certified cables.
- Multiple mounting possible with Switches with Plungers.
- Models with red LED indicators added to series for easy confirmation of operation.
(Set by default to light for non-operation.)
- VCTF cables with CE marking.
(Applicable only to standard models.)



Model Number Structure

Model Number Legend

Standard Models

D4C-□□□
(1)(2)(3)

(1) Rated Current

- 1: 5 A at 250 VAC, 4 A at 30 VDC
- 2: 5 A at 125 VAC (with LED indicator)
- 3: 4 A 30 VDC (with LED indicator)
- 4: 0.1 A at 125 VAC, 0.1 A at 30 VDC
- 5: 0.1 A at 125 VAC (with LED indicator)
- 6: 0.1 A at 30 VDC (with LED indicator)

(2) Cable Specifications

- 2: VCTF oil-resistant cable (3 m)
- 3: VCTF oil-resistant cable (5 m)
- 4: VCTF (3 m)
- 5: VCTF (5 m)
- 6: SJT(O) (3 m)
- 7: SJT(O) (5 m)

(3) Actuator

- 01: Pin plunger
- 02: Roller plunger
- 03: Crossroller plunger
- 20: Roller lever
- 24: Roller lever (high-sensitivity model)
- 31: Sealed pin plunger
- 32: Sealed roller plunger
- 33: Sealed crossroller
- 50: Plastic rod
- 60: Center roller lever

Pre-wired Models

D4C-□0□□-□□□□□□
(1) (2) (3) (4)

(1) Rated Current

- 1: 1 A at 125 VAC, 1 A at 30 VDC
(Without operation indicator)
- 2: 1 A at 125 VAC (with operation indicator)
- 3: 1 A at 30 VDC (with operation indicator)

(2) Actuator

- 01: Pin plunger
- 02: Roller plunger
- 31: Sealed plunger
- 32: Sealed roller plunger
- 24: Roller lever (high-sensitivity model)

(3) Wiring Specifications

- DK1EJ: Pre-wired models
(3 conductors: DC specification)
- AK1EJ: Pre-wired models
(3 conductors: AC specification)
- M1J: Connector models for ASI devices
(2 conductors: NO wiring)

(4) Cable length

- 03: 0.3 m

Wiring Specifications

Internal switch	Connector
COM	3
NC	2
NO	4

Weather-resistant Models

D4C-□□□□-P
(1)(2)(3) (4)

(1) Rated Current

- 1: 5 A at 250 VAC, 4 A at 30 VDC
- 2: 5 A at 125 VAC (with LED indicator)
- 3: 4 A at 30 VDC (with LED indicator)
- 4: 0.1 A at 125 VAC, 0.1 A at 30 VDC

(2) Cable Specifications

- 2: VCTF oil-resistant cable (3 m)
- 3: VCTF oil-resistant cable (5 m)

(3) Actuator

- 20: Roller lever
- 24: Roller lever (high-sensitivity model)
- 27: Adjustable roller lever
- 29: Adjustable rod lever











(4) Structure

- P: Weather-resistant

Ordering Information

Switches

Switches with No Operation Indicator

Actuator	Ratings Cable Cable length (m)	Standard 5 A at 250 VAC, 4 A at 30 VDC			Microload 0.1 A at 125 VAC, 0.1 A at 30 VDC	
		VCTF oil-resistant cable *1	VCTF cable *2	SJT(O) cable *3	VCTF oil-resistant cable *1	VCTF cable *2
		Model				
Pin plunger 	3	D4C-1201	D4C-1401	D4C-1601	D4C-4201	D4C-4401
	5	D4C-1301	D4C-1501	D4C-1701	D4C-4301	D4C-4501
Roller plunger 	3	D4C-1202	D4C-1402	D4C-1602	D4C-4202	D4C-4402
	5	D4C-1302	D4C-1502	D4C-1702	D4C-4302	D4C-4502
Crossroller plunger 	3	D4C-1203	D4C-1403	D4C-1603	D4C-4203	D4C-4403
	5	D4C-1303	D4C-1503	D4C-1703	D4C-4303	D4C-4503
Roller lever 	3	D4C-1220	D4C-1420	D4C-1620	D4C-4220	D4C-4420
	5	D4C-1320	D4C-1520	D4C-1720	D4C-4320	D4C-4520
Roller lever, high -sensitivity 	3	D4C-1224	D4C-1424	D4C-1624	D4C-4224	D4C-4424
	5	D4C-1324	D4C-1524	D4C-1724	D4C-4324	D4C-4524
Sealed pin plunger 	3	D4C-1231	D4C-1431	D4C-1631	D4C-4231	D4C-4431
	5	D4C-1331	D4C-1531	D4C-1731	D4C-4331	D4C-4531
Sealed roller plunger 	3	D4C-1232	D4C-1432	D4C-1632	D4C-4232	D4C-4432
	5	D4C-1332	D4C-1532	D4C-1732	D4C-4332	D4C-4532
Sealed crossroller plunger 	3	D4C-1233	D4C-1433	D4C-1633	D4C-4233	D4C-4433
	5	D4C-1333	D4C-1533	D4C-1733	D4C-4333	D4C-4533
Plastic rod 	3	D4C-1250	D4C-1450	D4C-1650	D4C-4250	D4C-4450
	5	D4C-1350	D4C-1550	D4C-1750	D4C-4350	D4C-4550
Center roller lever 	3	D4C-1260	D4C-1460	D4C-1660	D4C-4260	D4C-4460
	5	D4C-1360	D4C-1560	D4C-1760	D4C-4360	D4C-4560

Note: 1. Models are available separately with resistance to viscous oils (oil drain holes are also available), but only with Plunger Models. Add "-M" to the model number (example: D4C-1202 would be D4C-1202-M).

2. Switches with variable roller levers are also available. Ask your nearest OMRON representative for details.

*1. Oil-resistant vinyl cable cables; approved by EN and IEC.

*2. Ordinary vinyl cable cables; approved by EN and IEC.

*3. Switches with SJT(O) Cables (cables approved by UL and CSA) are approved by UL and CSA.

Specifications

Approved Standards

Agency	Standard	File No.
TÜV Product Service	EN60947-5-1	*1, 3
UL	UL508	E76675 *2
CSA	CSA C22.2 No.14	LR45746 *2
CCC(CQC)	GB14048.5	2003010305077626 *3

*1. Models with VCTF oil-resistant cables and pre-wired models only. (Applicable only to standard models listed on pages 2 to 4.)

*2. SJT(O)-cable models only.

(Applicable only to standard models listed on pages 2 to 3.)

*3. Ask your OMRON representative for information on approved models.

Ratings

Standard Model

Rated voltage	Non-inductive load (A)				Inductive load (A)			
	Resistive load		Lamp load		Inductive load		Motor load	
	NC	NO	NC	NO	NC	NO	NC	NO
125 VAC	5 (0.1)		1.5	0.7	3		2.5	1.3
250 VAC	5		1	0.5	2		1.5	0.8
8 VDC	5 (0.1)		2		5	4	3	
14 VDC	5 (0.1)		2		4	4	3	
30 VDC	4 (0.1)		2		3	3	3	
125 VDC	0.4		0.05		0.4		0.05	
250 VDC	0.2		0.03		0.2		0.03	

Inrush current	NC	20 A max.
	NO	10 A max.

Note: 1. The values given on the left are steady-state currents.

2. Inductive loads have a power factor of 0.4 min. (AC) and a time constant of 7 ms max. (DC).

3. Lamp loads have an inrush current of 10 times the steady-state current.

4. Motor loads have an inrush current of 6 times the steady-state current.

5. The values "0.1" given in parentheses are for micro load models.

Pre-wired Model

Rated voltage	Non-inductive load(A)				Inductive load(A)			
	Resistive load		Lamp load		Inductive load		Motor load	
	NC	NO	NC	NO	NC	NO	NC	NO
125 VAC	1	1	1	0.7	1	1	1	1
30 VDC	1	1	1	1	1	1	1	1

Approved Standard Ratings

TÜV(EN60947-5-1),CCC(GB14048.5)

Model	Applicable category and ratings	I the
D4C-1□□□□	AC-15 2 A/250 V DC-12 2 A/30 V	5 A 4 A
D4C-2□□□□	AC-15 2 A/125 V	5 A
D4C-3□□□□	DC-12 2 A/30 V	4 A
D4C-4□□□□	AC-14 0.1 A/125 V DC-12 0.1 A/30 V	0.5 A 0.5 A
D4C-5□□□□	AC-14 0.1 A/125 V	0.5 A
D4C-6□□□□	DC-12 0.1 A/30 V	0.5 A

UL/CSA

B300 (D4C-16□□□, -17□□□)

B150 (D4C-26□□□, -27□□□)

B300

Rated voltage	Carry current	Current(A)		Volt-amperes(VA)	
		Make	Break	Make	Break
120 VAC	5 A	30	3	3,600	360
240 VAC		15	1.5	3,600	360

B150

Rated voltage	Carry current	Current(A)		Volt-amperes(VA)	
		Make	Break	Make	Break
120 VAC	5 A	30	3	3,600	360

Characteristics

Degree of protection	IP67	
Durability *1	Mechanical *3	10,000,000 operations min.
	Electrical *2	200,000 operations min. (5 A at 125 VAC, resistive load)
Operating speed	0.1 mm/s to 0.5 m/s (in case of plunger) 1 mm/s to 1 m/s (in case of roller lever)	
Operating frequency	Mechanical	120 operations/min
	Electrical	30 operations/min
Rated frequency	50/60 Hz	
Insulation resistance	100 MΩ min. (at 500 VDC)	
Contact resistance (initial)	250 mΩ max. (initial value with 2-m VCTF cable)	
	300 mΩ max. (initial value with 3-m VCTF cable)	
	400 mΩ max. (initial value with 5-m VCTF cable)	
Dielectric strength	Between terminals of the same polarity	1,000 VAC, 50/60 Hz for 1 min
	Between current-carrying metal part and ground	1,500 VAC, 50/60 Hz for 1 min Uimp: 2.5 kV(EN60947-5-1)
	Between each terminal and non-current-carrying metal part,	1,500 VAC, 50/60 Hz for 1 min Uimp: 2.5 kV(EN60947-5-1)
Rated insulation voltage (Ui)	300 V (EN60947-5-1) *5	
Pollution degree (operating environment)	3 (EN60947-5-1)	
Short-circuit protective device (SCPD)	10 A fuse type gl or gG (IEC60269)	
Conditional short-circuit current	100 A (EN60947-5-1)	
Conventional enclosed thermal current (I the)	5 A, 4 A, 0.5 A (EN60947-5-1)	
Protection against electric shock	Class I (with grounding wire) *6	
Vibration resistance	Malfunition	10 to 55 Hz, 1.5-mm double amplitude *4
Shock resistance	Destruction	1,000 m/s ² min.
	Malfunition	500 m/s ² min. *4
Ambient operating temperature	-10°C to +70°C (with no icing)	
Ambient operating humidity	35% to 95%RH	
Weight (D4C-1202)	With 3-m VCTF cable: 360 g	
	With 5-m VCTF cable: 540 g	

Note: The above figures are initial values.

*1. The values are calculated at an operating temperature of +5°C to +35°C, and an operating humidity of 40% to 70%RH. Contact your OMRON sales representative for more detailed information on other operating environments.

*2. Pre-wired Models: 1,000,000 operations min. (DC specifications, switching current: 0.1 A)

*3. Outdoor specifications: 500,000 operations min.

*4. Excluding Plastic Rods.

*5. Pre-wired models: 250 V

*6. Pre-wired models: class III

Contact Form

Standard Models/Weather-resistant Models

Without Operation Indicator

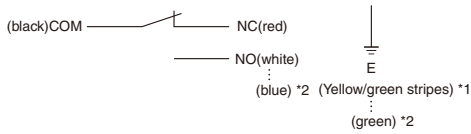

**With Operation Indicator
(Lit when Not Actuated)**

<24 VDC LED>

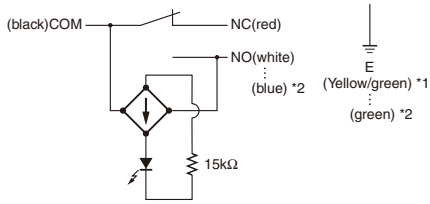

<100 VAC LED>

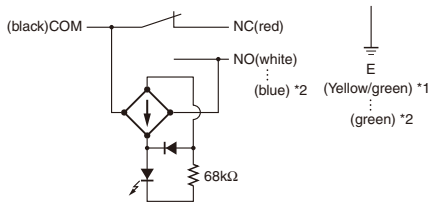

Connector Models for ASI Devices (-M1J)

Without Operation Indicator

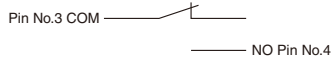

**With Operation Indicator
(Lit when Not Actuated)**

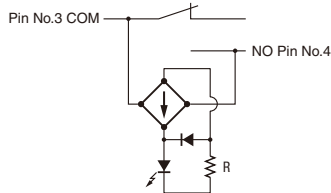

For DC

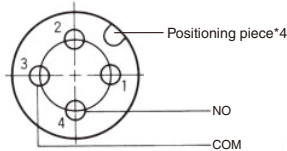

Pre-wired Models (-AK1EJ□, -DK1EJ□)

Without Operation Indicator

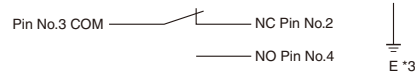

**With Operation Indicator
(Lit when Not Actuated)**

<24 VDC LED>

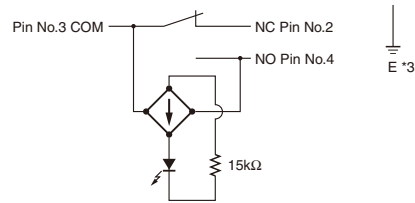

<100 VAC LED>

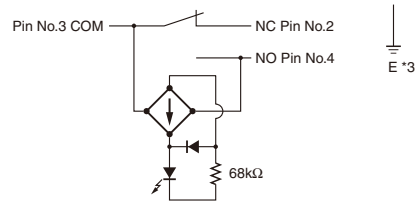

For AC

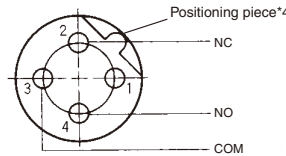

For DC

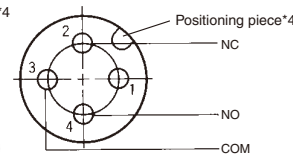

- *1. Yellow/green: VCTF oil-resistant cable
Green: VCTF cable
 - *2. SJT(O) cable approved by UL and CSA.
 - *3. E (ground) is not grounded.
 - *4. The position of the positioning piece is not fixed. Using an L-shaped connector may result in failure. Use only a straight connector.
- Note: "Lit when not Actuated" means that when the actuator is in the free position, the indicator is lit, and when the actuator is turned or pushed and the contact comes into contact with the NO side, the indicator turns OFF.

Sealed Plunger
D4C-□□31

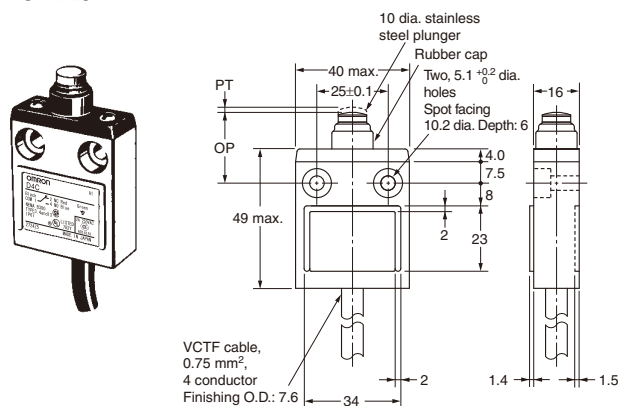

Sealed Roller Plunger
D4C-□□32

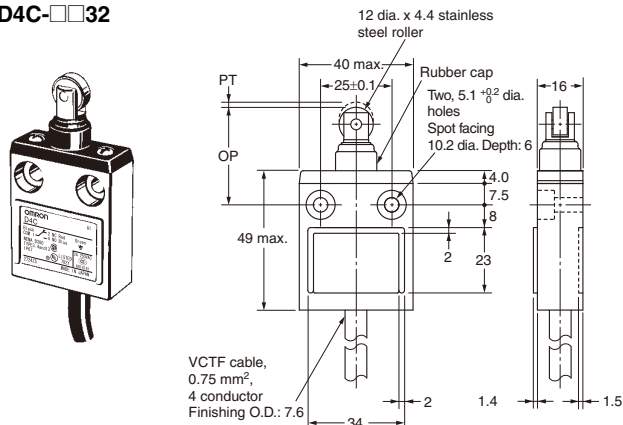

Sealed Crossroller Plunger
D4C-□□33

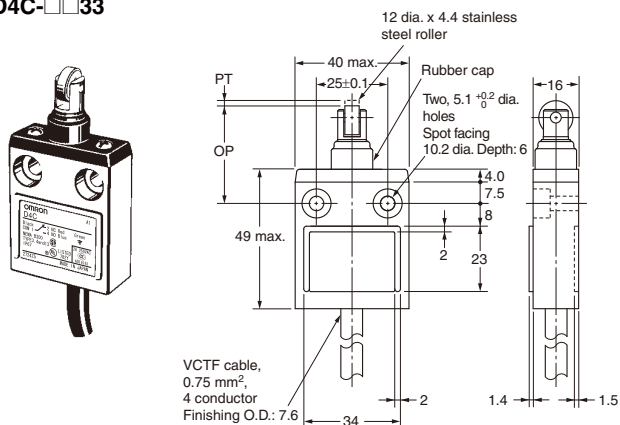

Note: Unless otherwise specified, a tolerance of ± 0.4 mm applies to all dimensions.

Operating characteristics		Model	D4C-□□31	D4C-□□32	D4C-□□33
Operating force	OF	max.	17.65 N	17.65 N	17.65 N
Release force	RF	min.	4.41 N	4.41 N	4.41 N
Pretravel	PT	max.	1.8 mm	1.8 mm	1.8 mm
Overtravel	OT	min.	3 mm	3 mm	3 mm
Movement Differential	MD	max.	0.2 mm	0.2 mm	0.2 mm
Operating Position	OP		24.9±1 mm	34.3±1 mm	34.3±1 mm
Total travel	TT *		(5) mm	(5) mm	(5) mm

* The TT is a reference value.