

QUALTEK ELECTRONICS

3 Conductor Power Cords - Unshielded

All cords have CEE Color Code, 60°C and 125VAC unless marked otherwise

**RoHS
Compliant**



C



D



E



F



G





















H



I

Part Number	Figure	Length	Cordage	# Cond AWG	Amp Rating	Plug No.	Conn No.	PDF Drawings
211012-06	C	8' 0"	SVT +	3 x 18	10	5-15P	--	
211018-06	C	8' 0"	SJT +	3 x 18	10	5-15P	--	
250071-01	-	12"	SJT +	3 x 18	10	IEC 60320 C14	5-15R	
311010-01	C	9' 10"	SVT	3 x 18	10	5-15P	--	
311016-01	C	9' 10"	SJT	3 x 18	10	5-15P	--	
311027-01	C	9' 10"	SJT	3 x 14	15	5-15P	--	

212004-01	D	7' 6"	SVT +	3 x 18	10	5-15P	IEC 60320 C13	
212013-01	D	7' 6"	SJT +	3 x 16	13	5-15P	IEC 60320 C13	
212099-01	D	6' 0"	SVT	3 x 18	10	5-15P	IEC 60320 C13	
312003-01	D	7' 6"	SVT	3 x 18	10	5-15P	IEC 60320 C13	
312007-01	D	6' 7"	SJT	3 x 18	10	5-15P	IEC 60320 C13	
312008-01	D	7' 6"	SJT	3 x 18	10	5-15P	IEC 60320 C13	
312010-01	D	9' 10"	SJT	3 x 18	10	5-15P	IEC 60320 C13	
312014-01	D	9' 10"	SJT	3 x 16	13	5-15P	IEC 60320 C13	
312019-01	D	9' 10"	SJT	3 x 14	15	5-15P	IEC 60320 C13	
312021-01	D	7' 6"	SVT ++	3 x 18	10	5-15P	IEC 60320 C13	
313001-01	E	7' 6"	SVT	3 x 18	10	5-15P	IEC 60320 C13 Right Angle	
313011-01	E	7' 6"	SJT	3 x 16	13	5-15P	IEC 60320 C13 Right Angle	
315008-01	F	9' 10"	SJT	3 x 18	10	--	IEC 60320 C13	
318002-01	G	3' 3"	SVT	3 x 18	10	IEC 60320 C14	IEC 60320 C13	
318005-01	G	3' 3"	SJT	3 x 18	10	IEC 60320 C14	IEC 60320 C13	
318007-01	G	3' 3"	SJT	3 x 16	13	IEC 60320 C14	IEC 60320 C13	
319002-T01*	H	3' 3"	SJT / H05VV-F	3 x 18 / 3 x 1.0mm ²	10	IEC 60320 C14	IEC 60320 C13	
319004-T01*	H	8' 2"	SJT / H05VV-F	3 x 18 / 3 x 1.0mm ²	10	IEC 60320 C14	IEC 60320 C13	
331010-01	I	9' 10"	SJT	3 x 14	15	IEC 60320 C20	IEC 60320 C19	

All cords have CEE Color Code (Brown/Blue/Green-Yellow), 60°C temperature rating unless marked otherwise

Note: -01 = Black, -06 = Gray

- + North American Color Code
- ++ Temperature Rating 105°C VW-1
- * Universal Jumper Cord: UL, cUL and VDE certified.

REVISION			
REV.	DESCRIPTION	DATE	APPROVED
B	RoHS Compliancy	06-01-06	D.P.

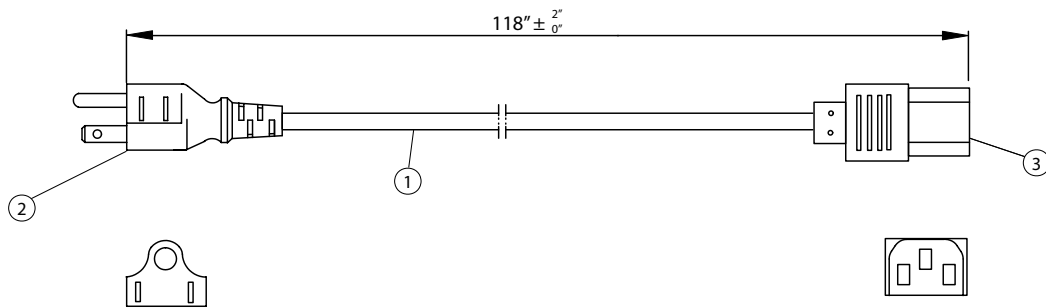

NOTES:

1. CORDAGE: SJT, 16AWG / 3C, UNSHIELDED, CEE COLOR CODE, TEMP. RATING 60°C, RATING: 125V 13A, JACKET COLOR: BLACK
2. PLUG: NEMA 5-15P
3. CONNECTOR: IEC 60320 C-13
4. APPROVALS: UL, cUL
5. ROHS COMPLIANT

CONTROLLED

Dim range (mm)		Tolerance +/- (mm)		Qualtek Electronics Corp. PPC DIVISION		
0-1	1-6	0.15	0.20	Part Number:	312014-01	RoHS Compliant
6-18	18-50	0.30	0.50	Description: POWER CORD		
50-120	120-250	0.70	0.90	UNIT: in	REV. B	
250-500		1.20		Drawn / Date	Checked / Date	Approved / Date
				S.TSAI 10-28-01	10-28-01	JJH / 10-28-01