

# Connecting Sockets, Mounting Brackets, DIN Rails

CSM\_ConnectionSocket\_DS\_E\_2\_1

## Durable, Easy-to-handle Connecting Sockets and Mounting Brackets

- Highly reliable Track-mounted and Back-connecting Sockets
- 61F Controllers and Surge Killer Units can be mounted securely and easily using Mounting Brackets and DIN Rails.

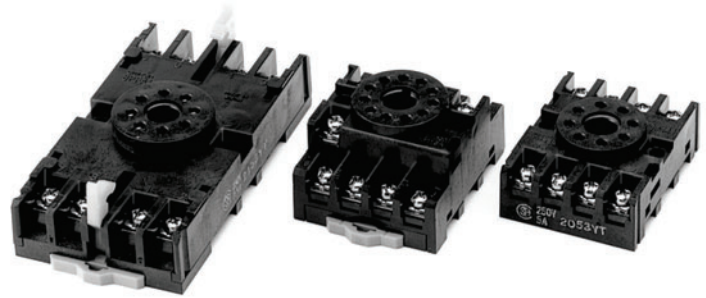

## ■ Ordering Information

### Connection Sockets

Controller Model	Type	Track-mounted Socket	Back-connecting Socket
		Model	Model
61F-UHS		8PFA1	PL08
61F-HSL		8PFA	
61F-APN2 61F-GP-N8□		PF083A-E	
61F-G1P□ 61F-G2P□ 61F-IP (-22)		14PFA	PL15
61F-GP-N□ 61F-03B 61F-GPN-BT/-BC 61F-04B		PF113A-E	PL11

### Mounting Brackets

Model
PFC-A1
PHC-5
PLC
PFC-N8 (See note.)

**Note:** PFC-N8 Mounting Brackets are included with 61F-GP-N□, 61F-GP-N8□, 61F-GPN-V50, 61F-GPN-BT/-BC, and 61F-APN2 Controllers.

### DIN Rails

Model
PFP-100N
PFP-50N
PFP-100N2
PFP-M
PFP-S

# Track-mounted Sockets

## PF083A-E

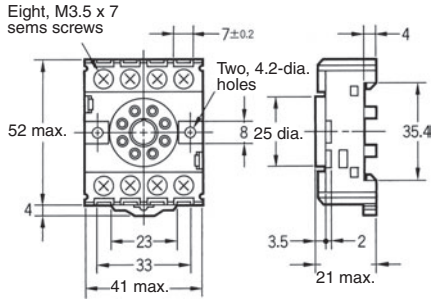
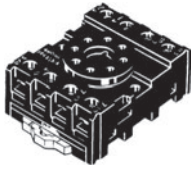

**Terminal Arrangement/  
Internal Connections  
(Top View)**

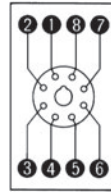

**Mounting Holes**

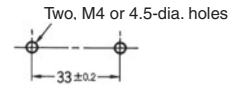

## 8PFA

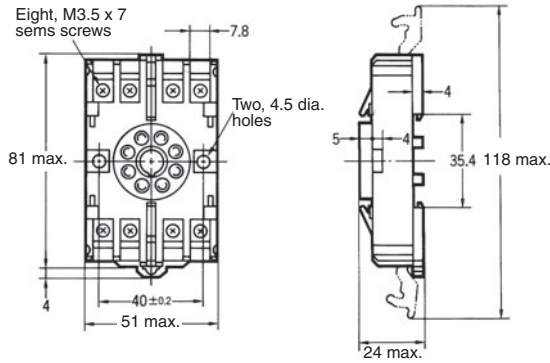
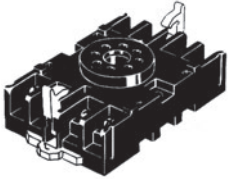

**Terminal Arrangement/  
Internal Connections  
(Top View)**

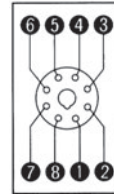

**Mounting Holes**

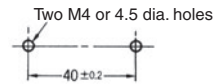

## 8PFA1

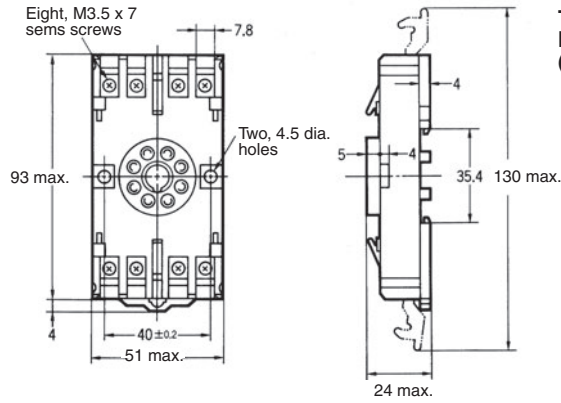
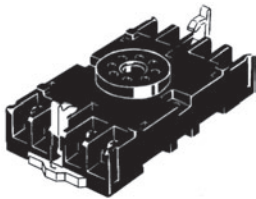

**Terminal Arrangement/  
Internal Connections  
(Top View)**

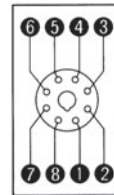

**Mounting Holes**

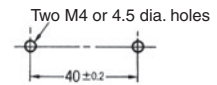

## 14PFA

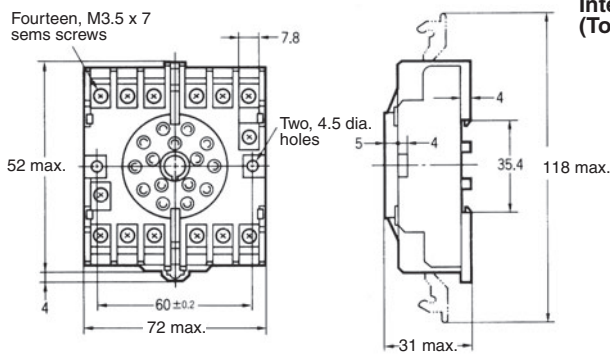
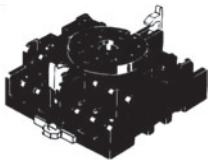

**Terminal Arrangement/  
Internal Connections  
(Top View)**

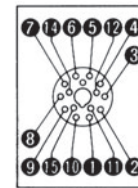

**Mounting Holes**

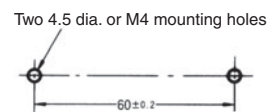

M3.5 x 11.5 sems screws for terminal screws

## PF113A-E

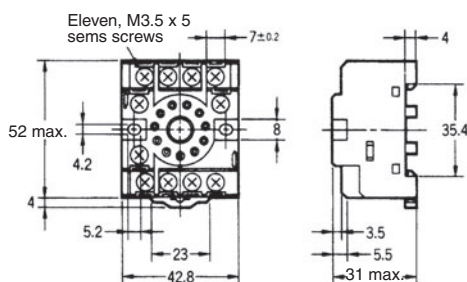

**Terminal Arrangement/  
Internal Connections  
(Top View)**

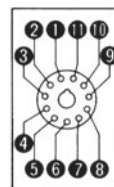

**Mounting Holes**

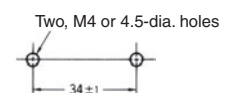

# Back-connecting Sockets

## PL08

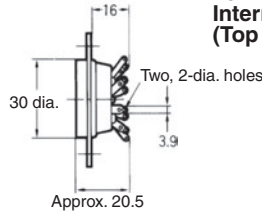
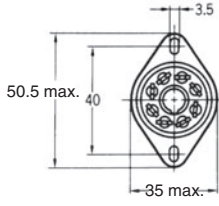
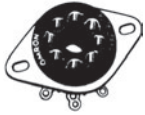

### Terminal Arrangement/ Internal Connections (Top View)

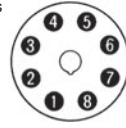

### Mounting Holes

Two, 3.5-dia. or M3 Controller Unit mounting holes

Two, 3.5-dia. or M3 Socket mounting holes

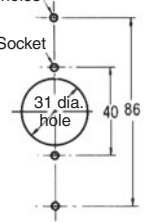

## PL11

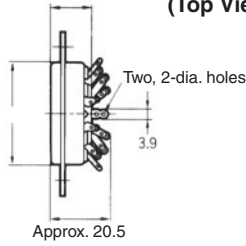
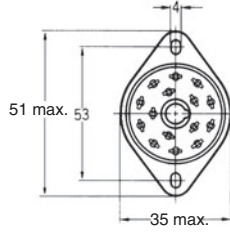
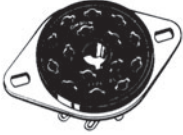

### Terminal Arrangement/ Internal Connections (Top View)

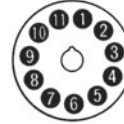

### Mounting Holes

Two, 3.5-dia. or M3 Socket mounting holes



## PL15

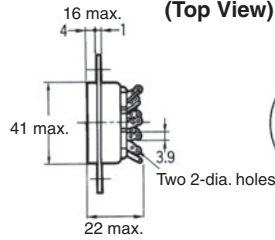
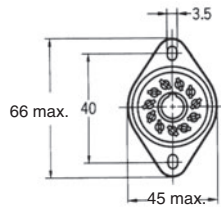
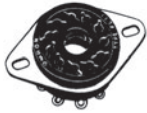

### Terminal Arrangement/ Internal Connections (Top View)

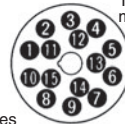

### Mounting Holes

Two, 3.5 dia. or M3 Controller Unit mounting holes

Two, 3.5-dia. or M3 Socket mounting holes

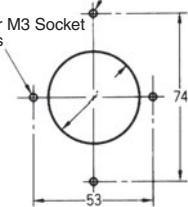

## ■ Mounting Brackets

When the 61F-G1P/-G2P/-IP/-UHS/-HSL is mounted using a Track-mounted Socket, the Switch is held secure by the hooks on the mounting Socket.

### 61F-GP-N8, 61F-APN2

To mount to the PF083A-E Track-mounted Socket, use the enclosed PFC-N8 Mounting Bracket.

**PFC-N8**

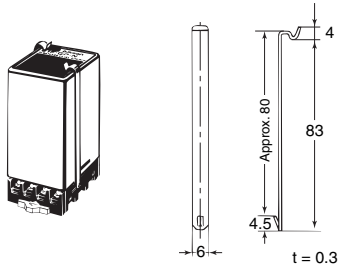

### 61F-GP-N, 61F-GPN-BT/-BC

To mount to the PF113A-E Track-mounted Socket, use the enclosed PFC-N8 Mounting Brackets.

**PFC-N8**

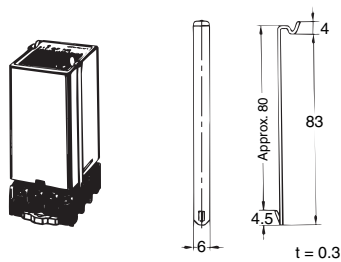

To mount to the PL11 Back-connecting Socket, use the PHC-5 Mounting Brackets.

**PHC-5**

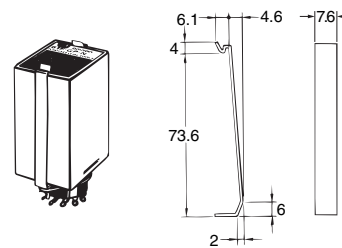

### 61F-03B, -04B

To mount to the PF113A-E Track-mounted Socket, use the PFC-A1 Mounting Brackets.

**PFC-A1**

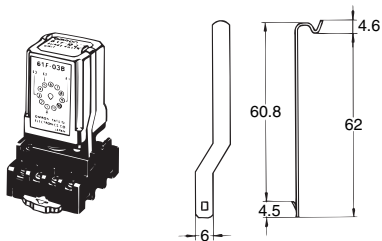

To mount to the PL11 Back-connecting Socket, use the PLC Mounting Brackets.

**PLC**

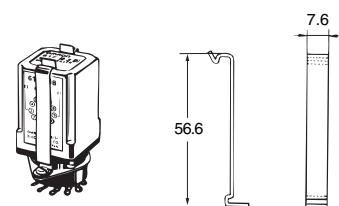

## ■ DIN Track Mounting Accessories

**DIN Track**  
PFP-100N  
PFP-50N

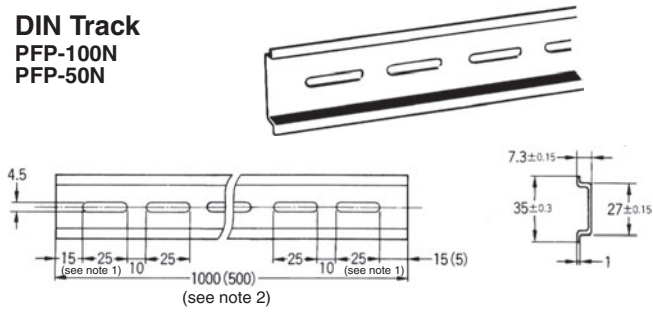

**End Plate**  
PFP-M

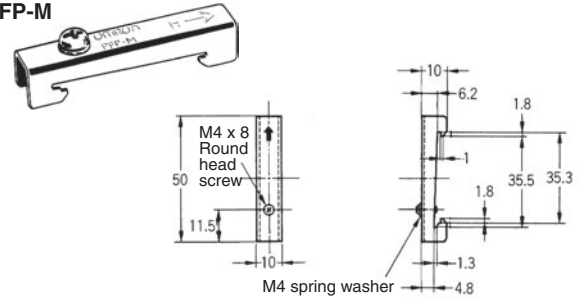

**DIN Track**  
PFP-100N2

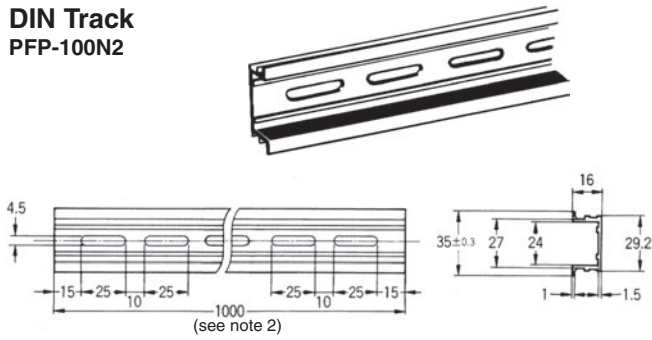

**Spacer**  
PFP-S

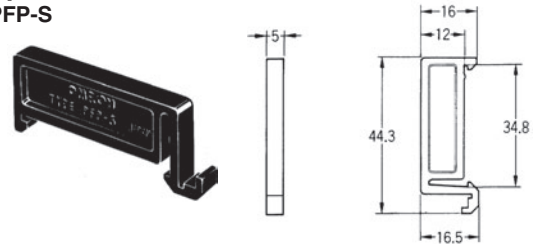

- Note:** 1. The PFP-100N is 15 mm on both ends, while the PFP50N is 15 mm on one end and 5 mm on the other end.  
2. Indicates total DIN Track length.

- 1 m: PFP-100N  
50 cm: PFP-50N  
1 m: PFP-100N2

ALL DIMENSIONS SHOWN ARE IN MILLIMETERS.

To convert millimeters into inches, multiply by 0.03937. To convert grams into ounces, multiply by 0.03527.

In the interest of product improvement, specifications are subject to change without notice.

## Read and Understand This Catalog

Please read and understand this catalog before purchasing the products. Please consult your OMRON representative if you have any questions or comments.

## Warranty and Limitations of Liability

### WARRANTY

OMRON's exclusive warranty is that the products are free from defects in materials and workmanship for a period of one year (or other period if specified) from date of sale by OMRON.

OMRON MAKES NO WARRANTY OR REPRESENTATION, EXPRESS OR IMPLIED, REGARDING NON-INFRINGEMENT, MERCHANTABILITY, OR FITNESS FOR PARTICULAR PURPOSE OF THE PRODUCTS. ANY BUYER OR USER ACKNOWLEDGES THAT THE BUYER OR USER ALONE HAS DETERMINED THAT THE PRODUCTS WILL SUITABLY MEET THE REQUIREMENTS OF THEIR INTENDED USE. OMRON DISCLAIMS ALL OTHER WARRANTIES, EXPRESS OR IMPLIED.

### LIMITATIONS OF LIABILITY

OMRON SHALL NOT BE RESPONSIBLE FOR SPECIAL, INDIRECT, OR CONSEQUENTIAL DAMAGES, LOSS OF PROFITS OR COMMERCIAL LOSS IN ANY WAY CONNECTED WITH THE PRODUCTS, WHETHER SUCH CLAIM IS BASED ON CONTRACT, WARRANTY, NEGLIGENCE, OR STRICT LIABILITY.

In no event shall the responsibility of OMRON for any act exceed the individual price of the product on which liability is asserted.

IN NO EVENT SHALL OMRON BE RESPONSIBLE FOR WARRANTY, REPAIR, OR OTHER CLAIMS REGARDING THE PRODUCTS UNLESS OMRON'S ANALYSIS CONFIRMS THAT THE PRODUCTS WERE PROPERLY HANDLED, STORED, INSTALLED, AND MAINTAINED AND NOT SUBJECT TO CONTAMINATION, ABUSE, MISUSE, OR INAPPROPRIATE MODIFICATION OR REPAIR.

## Application Considerations

### SUITABILITY FOR USE

OMRON shall not be responsible for conformity with any standards, codes, or regulations that apply to the combination of products in the customer's application or use of the products.

At the customer's request, OMRON will provide applicable third party certification documents identifying ratings and limitations of use that apply to the products. This information by itself is not sufficient for a complete determination of the suitability of the products in combination with the end product, machine, system, or other application or use.

The following are some examples of applications for which particular attention must be given. This is not intended to be an exhaustive list of all possible uses of the products, nor is it intended to imply that the uses listed may be suitable for the products:

- Outdoor use, uses involving potential chemical contamination or electrical interference, or conditions or uses not described in this catalog.
- Nuclear energy control systems, combustion systems, railroad systems, aviation systems, medical equipment, amusement machines, vehicles, safety equipment, and installations subject to separate industry or government regulations.
- Systems, machines, and equipment that could present a risk to life or property.

Please know and observe all prohibitions of use applicable to the products.

NEVER USE THE PRODUCTS FOR AN APPLICATION INVOLVING SERIOUS RISK TO LIFE OR PROPERTY WITHOUT ENSURING THAT THE SYSTEM AS A WHOLE HAS BEEN DESIGNED TO ADDRESS THE RISKS, AND THAT THE OMRON PRODUCTS ARE PROPERLY RATED AND INSTALLED FOR THE INTENDED USE WITHIN THE OVERALL EQUIPMENT OR SYSTEM.

### PROGRAMMABLE PRODUCTS

OMRON shall not be responsible for the user's programming of a programmable product, or any consequence thereof.

## Disclaimers

### CHANGE IN SPECIFICATIONS

Product specifications and accessories may be changed at any time based on improvements and other reasons.

It is our practice to change model numbers when published ratings or features are changed, or when significant construction changes are made. However, some specifications of the products may be changed without any notice. When in doubt, special model numbers may be assigned to fix or establish key specifications for your application on your request. Please consult with your OMRON representative at any time to confirm actual specifications of purchased products.

### DIMENSIONS AND WEIGHTS

Dimensions and weights are nominal and are not to be used for manufacturing purposes, even when tolerances are shown.

### PERFORMANCE DATA

Performance data given in this catalog is provided as a guide for the user in determining suitability and does not constitute a warranty. It may represent the result of OMRON's test conditions, and the users must correlate it to actual application requirements. Actual performance is subject to the OMRON Warranty and Limitations of Liability.

### ERRORS AND OMISSIONS

The information in this document has been carefully checked and is believed to be accurate; however, no responsibility is assumed for clerical, typographical, or proofreading errors, or omissions.

2010.3

In the interest of product improvement, specifications are subject to change without notice.

**OMRON Corporation**  
Industrial Automation Company

<http://www.ia.omron.com/>

(c)Copyright OMRON Corporation 2010 All Right Reserved.