

HARTING Electric

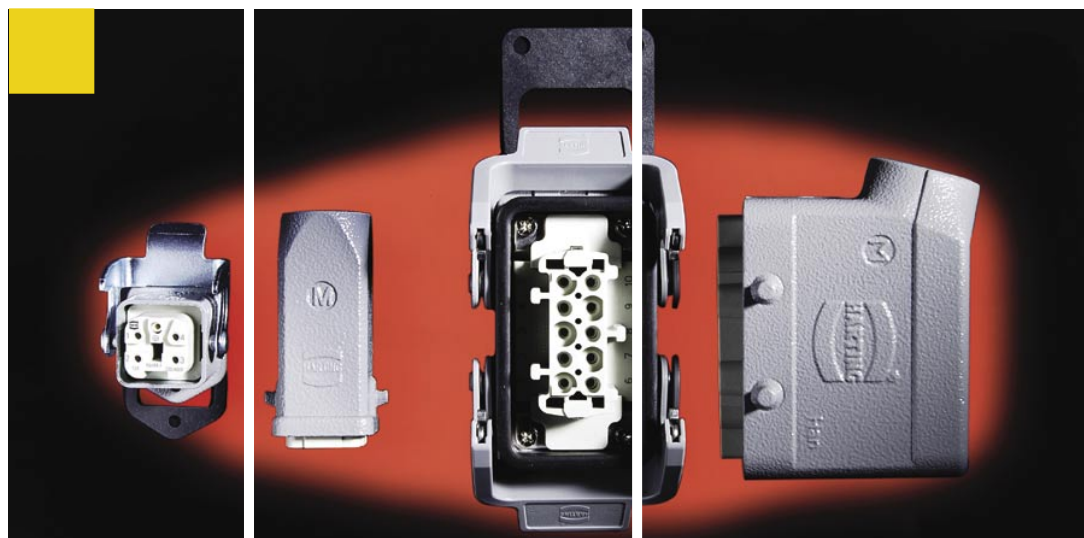

Han-Kit® Complete Connector Sets

Industrial Connectors for Applications
up to 500 V / 16 A



People | Power | Partnership

Economical and Reliable Connections - 1 Kit per Package - Easy Choice for You!

Specifications

VDE 0110 Table for clearance and creepage distances
 DIN EN 61 984
 VDE 0627 Connectors
 Safety requirements and Tests

Standards

DIN EN 175 301-801

Approvals

UL, CSA, SEV for inserts



Certified accord. to EN ISO 9001 in design/ development, production, installation and service.

General Remarks:

It is the user's responsibility to check whether the components belonging to these kits comply with different regulations from those stated in special fields of application which we are unable to foresee.

We reserve the right to modify designs in order to improve quality and keep pace with technological requirements in production.

No part of this information leaflet must be reproduced in any form (print, photocopy, microfilm or any other process) processed, duplicated or distributed by means of electronic systems without the written permission of HARTING ELectric GmbH & Co. KG, Espelkamp (Copyright Law, Fair Trading Law, Civil Code).

We are bound by the German version only.

Note

Connectors should not be coupled or decoupled under electrical load.

Connectors of the same or different series being mounted side by side may be protected against incorrect mating by the use of coding options.

Han® 3 A

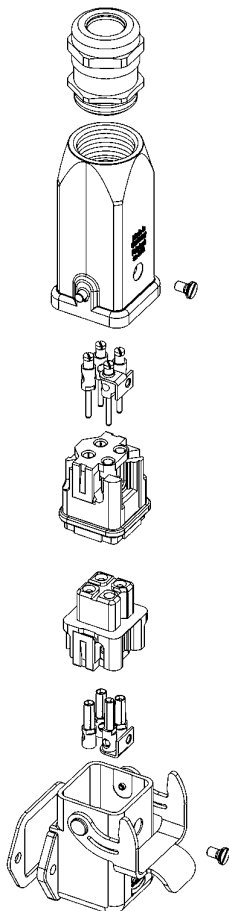

Connector Set Up

Cable Gland

Hood

Male contacts

Male insert

Female insert

Female contacts

Bulkhead mounted housing

Han® 10 B

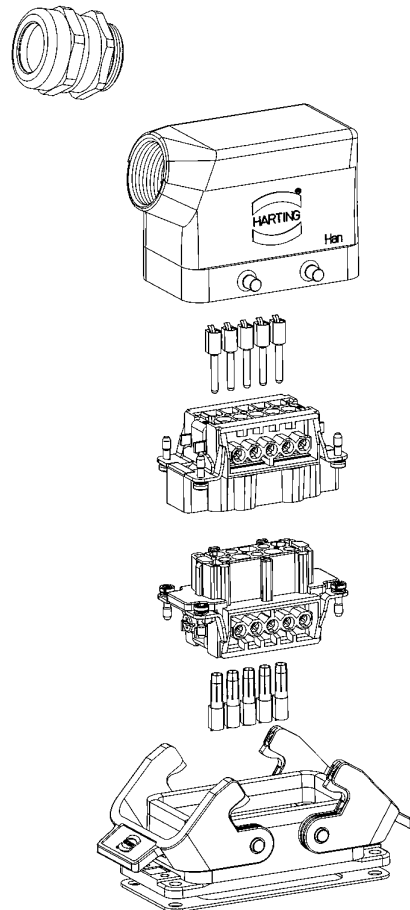

Screw Terminal

Inserts	Stripping length a (mm)	Sheath length x (mm)
Han 3A ... + 4A...	4.5	40
Han 10 A	7	85
Han 16 A	7	100
Han 6 E	7	70
Han 10 E	7	90
Han 16 E	7	110
Han 24 E	7	130

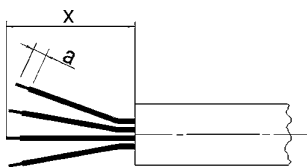

Recommended Tightening Torques and Screw Driver Blades				
Size of screw	Type of connector	Tightening torque [Nm]	Tightening torque [lbf]	Recomm. screw driver blade [mm]
M3	Screw terminal Han 3A.../4A...	0.25	0.4	0.5 x 2.5
M3	Screw terminal Han 10A + 16A Han 6B - 24 B	0.5	0.4	0.5 x 3.5
M3.5	PE contact Han 10A + 16A	1.2	0.9	0.5 x 3.5
M4	PE contact Han 6B - 24 B	1.2	0.9	0.5 x 3.5

Derating Diagrammes

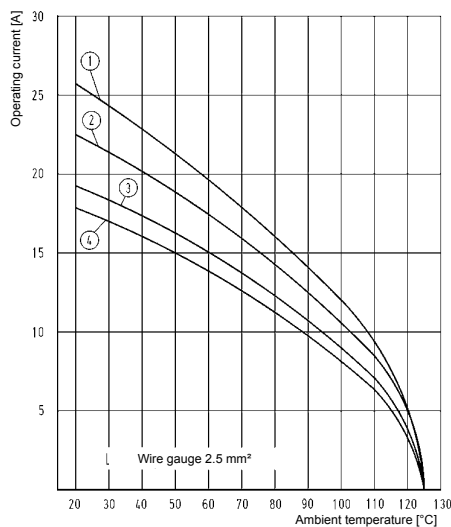

The current carrying capacity is limited by the thermal properties of materials which are used for inserts as well as by the insulation materials. The rated current is the continuous, not interrupted current a connector can take when simultaneous power on all contacts is given, without exceeding the maximum temperature according to DIN IEC 60 512-3.

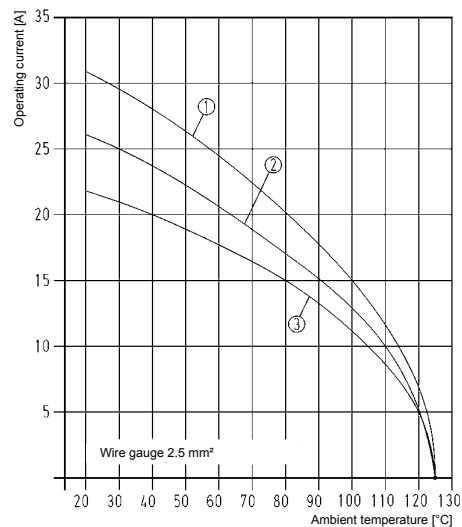

- 1 = Han 6 E
- 2 = Han 10 E
- 3 = Han 16 E
- 4 = Han 24 E

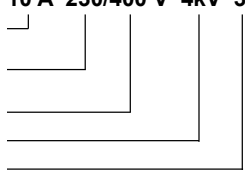
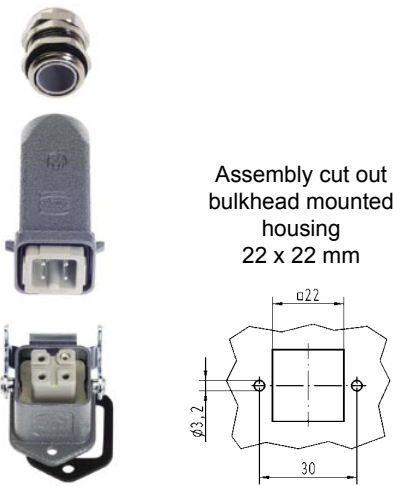
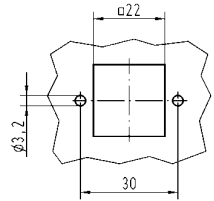
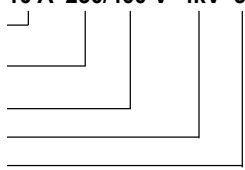

- 1 = Han 3 A / 4 A
- 2 = Han 10 A
- 3 = Han 16 A

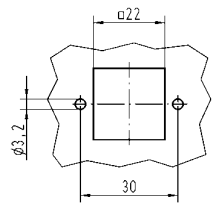
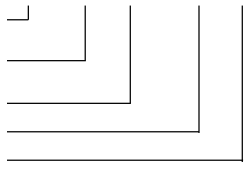
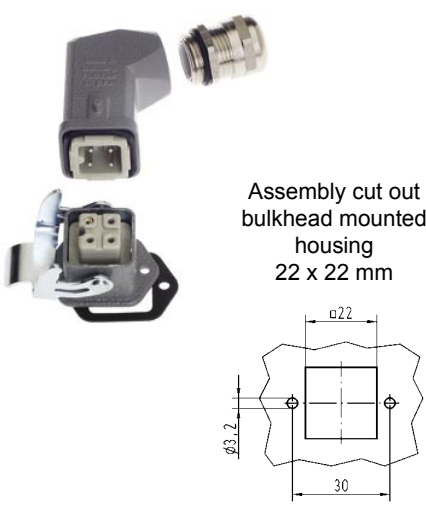
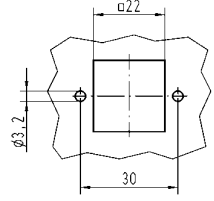
Han® 3 A Metal Version	Part-Number	Dimensions in mm
<p>Han-Kit®-3AGM</p> <p>Hood Han® 3 A straight Bulkhead mounted hous.¹⁾ Han® 3 A straight Material Die cast zinc alloy Protection degree²⁾ IP 67 Cable gland M20, metal Cable diameter 5 - 9 mm / 6 - 12 mm Insert Han® 3 A, 3-pins + PE Screw terminal 1-2.5 mm², AWG 18-14 Electrical data accd. to DIN EN 61 984³⁾ 10 A 230/400 V 4kV 3</p>  <p>Rated current Rated voltage conductor-ground Rated voltage conductor-conductor Rated impulse voltage Pollution degree Rated voltage accd. to UL/CSA 600 V</p>	<p>10 20 003 0001</p>	 <p>Assembly cut out bulkhead mounted housing 22 x 22 mm</p> 
<p>Han-Kit®-3AWM</p> <p>Hood Han® 3 A straight Bulkhead mounted hous.¹⁾ Han® 3 A angled Material Die cast zinc alloy Protection degree²⁾ IP 67 Cable gland M20, metal Cable diameter 5 - 9 mm / 6 - 12 mm Insert Han® 3 A, 3-pins + PE Screw terminal 1-2.5 mm², AWG 18-14 Electrical data accd. to DIN EN 61 984³⁾ 10 A 230/400 V 4kV 3</p>  <p>Rated current Rated voltage conductor-ground Rated voltage conductor-conductor Rated impulse voltage Pollution degree Rated voltage accd. to UL/CSA 600 V</p>	<p>10 20 003 0003</p>	 <p>Assembly cut out bulkhead mounted housing 22 x 22 mm</p> 
<p>Han-Kit®-3AWSM</p> <p>Hood Han® 3 A angled Bulkhead mounted hous.¹⁾ Han® 3 A straight Material Die cast zinc alloy Protection degree²⁾ IP 67 Cable gland M20, metal Cable diameter 5 - 9 mm / 6 - 12 mm Insert Han® 3 A, 3-pins + PE Screw terminal 1-2.5 mm², AWG 18-14 Electrical data accd. to DIN EN 61 984³⁾ 10 A 230/400 V 4kV 3</p>  <p>Rated current Rated voltage conductor-ground Rated voltage conductor-conductor Rated impulse voltage Pollution degree Rated voltage accd. to UL/CSA 600 V</p>	<p>10 20 003 0005</p>	 <p>Assembly cut out bulkhead mounted housing 22 x 22 mm</p> 

1) Bulkhead mounted housing with flange gasket
 2) Protection degree acc. to DIN EN 60 529 in locked position
 3) For only use in grounded circuits

Han® 3 A Plastic Version

Part-Number

Dimensions in mm

Han-Kit®-3AGK

Hood	Han® 3 A straight
Bulkhead mounted hous. ¹⁾	Han® 3 A straight
Material	Plastic
Protection degree ²⁾	IP 67
Cable gland	M20, plastic
Cable diameter	5 - 9 mm / 6 - 12 mm
Insert	Han® 3 A, 3-pins + PE
Screw terminal	1-2.5 mm ² , AWG 18-14
Electrical data accd. to DIN EN 61 984 ³⁾	10 A 230/400 V 4kV 3
Rated current	
Rated voltage conductor-ground	
Rated voltage conductor-conductor	
Rated impulse voltage	
Pollution degree	
Rated voltage accd. to UL/CSA	600 V

10 20 003 0002



Assembly cut out bulkhead mounted housing 22 x 22 mm

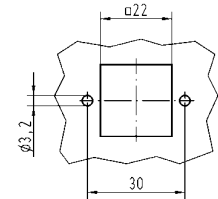

Han-Kit®-3AWK

Hood	Han® 3 A straight
Bulkhead mounted hous. ¹⁾	Han® 3 A angled
Material	Plastic
Protection degree ²⁾	IP 67
Cable gland	M20, plastic
Cable diameter	5 - 9 mm / 6 - 12 mm
Insert	Han® 3 A, 3-pins + PE
Screw terminal	1-2.5 mm ² , AWG 18-14
Electrical data accd. to DIN EN 61 984 ³⁾	10 A 230/400 V 4kV 3
Rated current	
Rated voltage conductor-ground	
Rated voltage conductor-conductor	
Rated impulse voltage	
Pollution degree	
Rated voltage accd. to UL/CSA	600 V





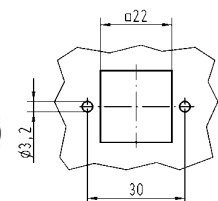

10 20 003 0004

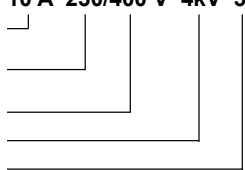

Assembly cut out bulkhead mounted housing 22 x 22 mm

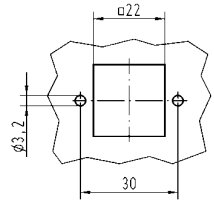
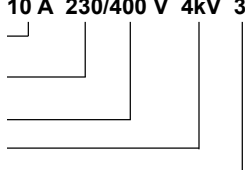

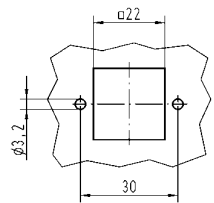
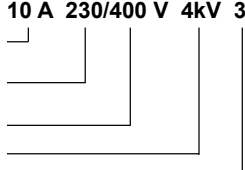
- 1) Bulkhead mounted housing with flange gasket
- 2) Protection degree acc. to DIN EN 60 529 in locked position
- 3) For only use in grounded circuits

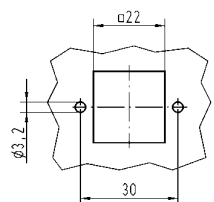
Han® 4 A Metal Version	Part-Number	Dimensions in mm
<p>Han-Kit®-4AGM</p> <p>Hood Han® 3 A straight Bulkhead mounted hous.¹⁾ Han® 3 A straight Material Die cast zinc alloy Protection degree²⁾ IP 67 Cable gland M20, metal Cable diameter 5 - 9 mm / 6 - 12 mm Insert Han® 4 A, 4-pins + PE Screw terminal 1-2.5 mm², AWG 18-14 Electrical data accd. to DIN EN 61 984³⁾ 10 A 230/400 V 4kV 3</p> <p>Rated current Rated voltage conductor-ground Rated voltage conductor-conductor Rated impulse voltage Pollution degree Rated voltage accd. to UL/CSA 600 V</p> 	<p>10 20 004 0001</p>	 <p>Assembly cut out bulkhead mounted housing 22 x 22 mm</p> 
<p>Han-Kit®-4AWM</p> <p>Hood Han® 3 A straight Bulkhead mounted hous.¹⁾ Han® 3 A angled Material Die cast zinc alloy Protection degree²⁾ IP 67 Cable gland M20, metal Cable diameter 5 - 9 mm / 6 - 12 mm Insert Han® 4 A, 4-pins + PE Screw terminal 1-2.5 mm², AWG 18-14 Electrical data accd. to DIN EN 61 984³⁾ 10 A 230/400 V 4kV 3</p> <p>Rated current Rated voltage conductor-ground Rated voltage conductor-conductor Rated impulse voltage Pollution degree Rated voltage accd. to UL/CSA 600 V</p> 	<p>10 20 004 0003</p>	 <p>Assembly cut out bulkhead mounted housing 22 x 22 mm</p> 
<p>Han-Kit®-4AWSM</p> <p>Hood Han® 3 A angled Bulkhead mounted hous.¹⁾ Han® 3 A straight Material Die cast zinc alloy Protection degree²⁾ IP 67 Cable gland M20, metal Cable diameter 5 - 9 mm / 6 - 12 mm Insert Han® 4 A, 4-pins + PE Screw terminal 1-2.5 mm², AWG 18-14 Electrical data accd. to DIN EN 61 984³⁾ 10 A 230/400 V 4kV 3</p> <p>Rated current Rated voltage conductor-ground Rated voltage conductor-conductor Rated impulse voltage Pollution degree Rated voltage accd. to UL/CSA 600 V</p> 	<p>10 20 004 0005</p>	 <p>Assembly cut out bulkhead mounted housing 22 x 22 mm</p> 

1) Bulkhead mounted housing with flange gasket
 2) Protection degree acc. to DIN EN 60 529 in locked position
 3) For only use in grounded circuits

Han® 4 A Plastic Version Part-Number Dimensions in mm

Han-Kit®-4AGK

Hood	Han® 3 A straight
Bulkhead mounted hous. ¹⁾	Han® 3 A straight
Material	Plastic
Protection degree ²⁾	IP 67
Cable gland	M20, plastic
Cable diameter	5 - 9 mm / 6 - 12 mm
Insert	Han® 4 A, 4-pins + PE
Screw terminal	1-2.5 mm ² , AWG 18-14
Electrical data accd. to DIN EN 61 984 ³⁾	10 A 230/400 V 4kV 3
Rated current	
Rated voltage conductor-ground	
Rated voltage conductor-conductor	
Rated impulse voltage	
Pollution degree	
Rated voltage accd. to UL/CSA	600 V

10 20 004 0002

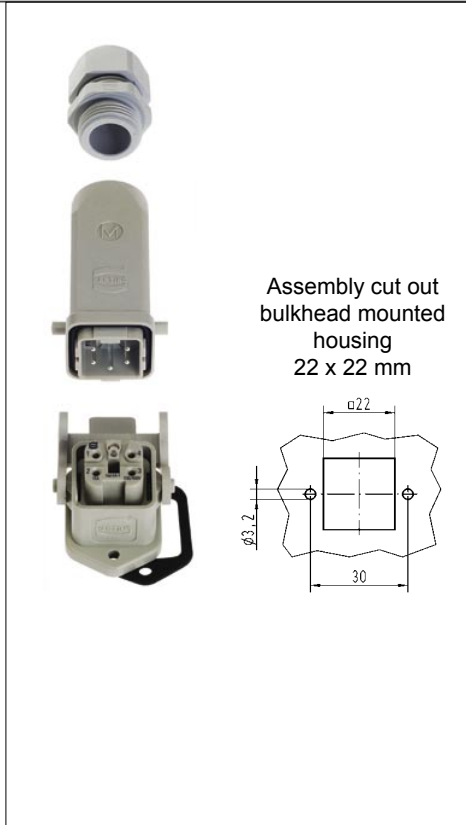

Han-Kit®-4AWK

Hood	Han® 3 A straight
Bulkhead mounted hous. ¹⁾	Han® 3 A angled
Material	Plastic
Protection degree ²⁾	IP 67
Cable gland	M20, plastic
Cable diameter	5 - 9 mm / 6 - 12 mm
Insert	Han® 4 A, 4-pins + PE
Screw terminal	1-2.5 mm ² , AWG 18-14
Electrical data accd. to DIN EN 61 984 ³⁾	10 A 230/400 V 4kV 3
Rated current	
Rated voltage conductor-ground	
Rated voltage conductor-conductor	
Rated impulse voltage	
Pollution degree	
Rated voltage accd. to UL/CSA	600 V

10 20 004 0004

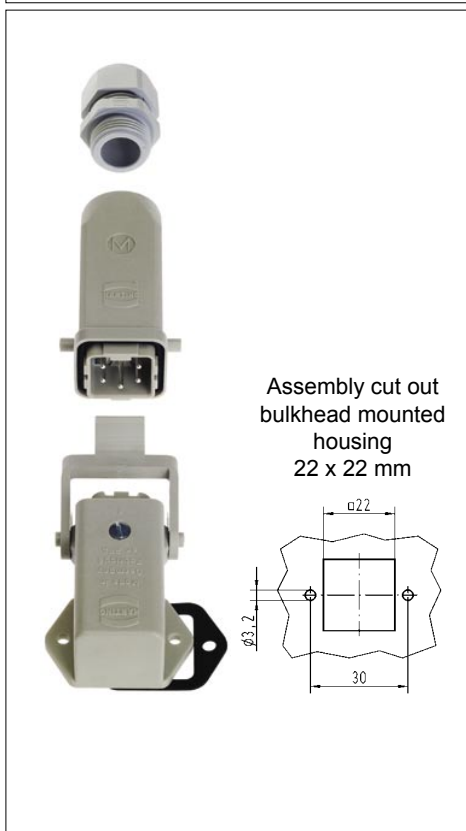

1) Bulkhead mounted housing with flange gasket
 2) Protection degree acc. to DIN EN 60 529 in locked position
 3) For only use in grounded circuits

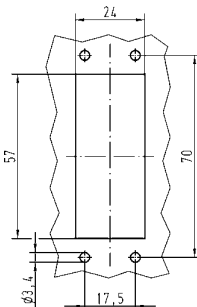
Han® 10 A	Part-Number	Dimensions in mm
<p>Han-Kit®-10A</p> <p>Hood¹⁾ Han® 10 A Material Die cast aluminium alloy Protection degree²⁾ IP 65 Cable gland M20, metal Cable diameter 5 - 9 mm / 6 - 12 mm</p> <p>Insert Han® 10 A, 10-pins + PE Screw terminal 1-2.5 mm², AWG 18-14</p> <p>Electrical data accd. to DIN EN 61 984³⁾ 16 A 250 V 4kV 3</p> <p>Rated current Rated voltage³⁾ Rated impulse voltage Pollution degree</p> <p>Rated voltage accd. to UL/CSA 600 V</p>	<p>10 20 010 0000</p>	 <p>Assembly cut out bulkhead mounted housing 57 x 24 mm</p> 

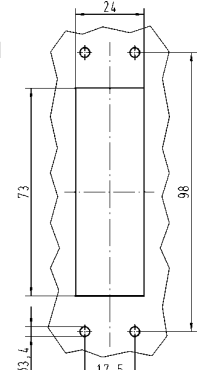
Han® 16 A	Part-Number	Dimensions in mm
<p>Han-Kit®-16A</p> <p>Hood¹⁾ Han® 16 A Material Die cast aluminium alloy Protection degree²⁾ IP 65 Cable gland M20, metal Cable diameter 5 - 9 mm / 6 - 12 mm</p> <p>Insert Han® 16 A, 16-pins + PE Screw terminal 1-2.5 mm², AWG 18-14</p> <p>Electrical data accd. to DIN EN 61 984³⁾ 16 A 250 V 4kV 3</p> <p>Rated current Rated voltage³⁾ Rated impulse voltage Pollution degree</p> <p>Rated voltage accd. to UL/CSA 600 V</p>	<p>10 20 016 0000</p>	 <p>Assembly cut out bulkhead mounted housing 73 x 24 mm</p> 

1) Bulkhead mounted housing with flange gasket
 2) Protection degree acc. to DIN EN 60 529 in locked position
 3) For use in a un-grounded circuit or a grounded delta circuit

Han® 6 B	Part-Number	Dimensions in mm								
<p>Han-Kit®-6B</p> <p>Hood¹⁾ Han® 6 B Material Die cast aluminium alloy Protection degree²⁾ IP 65 Cable gland M20, metal Cable diameter 5 - 9 mm / 6 - 12 mm</p> <p>Insert Han® 6 E, 6-pins + PE Screw terminal 1-2.5 mm², AWG 18-14</p> <p>Electrical data accd. to DIN EN 61 984³⁾ 16 A 500 V 6kV 3</p> <p>Rated current Rated voltage³⁾ Rated impulse voltage Pollution degree</p> <p>Rated voltage accd. to UL/CSA 600 V</p>	<p>10 33 006 0000</p>	 <table border="1" style="margin-left: auto; margin-right: auto;"> <thead> <tr> <th>Dimensions in mm</th> <th>Han-Kit 6 B</th> </tr> </thead> <tbody> <tr> <td>a</td> <td>48</td> </tr> <tr> <td>b</td> <td>70</td> </tr> <tr> <td>Assembly cut out bulkhead mounted housing</td> <td>48x35</td> </tr> </tbody> </table> 	Dimensions in mm	Han-Kit 6 B	a	48	b	70	Assembly cut out bulkhead mounted housing	48x35
Dimensions in mm	Han-Kit 6 B									
a	48									
b	70									
Assembly cut out bulkhead mounted housing	48x35									

Han® 10 B	Part-Number	Dimensions in mm								
<p>Han-Kit®-10B</p> <p>Hood¹⁾ Han® 10 B Material Die cast aluminium alloy Protection degree²⁾ IP 65 Cable gland M25, metal Cable diameter 9 - 16 mm / 13 - 18 mm</p> <p>Insert Han® 10 E, 10-pins + PE Screw terminal 1-2.5 mm², AWG 18-14</p> <p>Electrical data accd. to DIN EN 61 984³⁾ 16 A 500 V 6kV 3</p> <p>Rated current Rated voltage³⁾ Rated impulse voltage Pollution degree</p> <p>Rated voltage accd. to UL/CSA 600 V</p>	<p>10 33 010 0000</p>	 <table border="1" style="margin-left: auto; margin-right: auto;"> <thead> <tr> <th>Dimensions in mm</th> <th>Han-Kit 10 B</th> </tr> </thead> <tbody> <tr> <td>a</td> <td>60</td> </tr> <tr> <td>b</td> <td>83</td> </tr> <tr> <td>Assembly cut out bulkhead mounted housing</td> <td>60 x 35</td> </tr> </tbody> </table> 	Dimensions in mm	Han-Kit 10 B	a	60	b	83	Assembly cut out bulkhead mounted housing	60 x 35
Dimensions in mm	Han-Kit 10 B									
a	60									
b	83									
Assembly cut out bulkhead mounted housing	60 x 35									

1) Bulkhead mounted housing with flange gasket
 2) Protection degree acc. to DIN EN 60 529 in locked position
 3) For use in a un-grounded circuit or a grounded delta circuit

Han® 16 B		Part-Number	Dimensions in mm								
<p>Han-Kit®-16B</p> <p>Hood¹⁾ Han® 16 B Material Die cast aluminium alloy Protection degree²⁾ IP 65 Cable gland M32, metal Cable diameter 13-20 mm / 18-25 mm Insert Han® 16 E, 16-pins + PE Screw terminal 1-2.5 mm², AWG 18-14 Electrical data accd. to DIN EN 61 984³⁾ 16 A 500 V 6kV 3 Rated current Rated voltage³⁾ Rated impulse voltage Pollution degree Rated voltage accd. to UL/CSA 600 V</p>		10 33 016 0000	<table border="1"> <thead> <tr> <th>Dimensions in mm</th> <th>Han-Kit 16 B</th> </tr> </thead> <tbody> <tr> <td>a</td> <td>82</td> </tr> <tr> <td>b</td> <td>103</td> </tr> <tr> <td>Assembly cut out bulkhead mounted housing</td> <td>82 x 35</td> </tr> </tbody> </table>	Dimensions in mm	Han-Kit 16 B	a	82	b	103	Assembly cut out bulkhead mounted housing	82 x 35
Dimensions in mm	Han-Kit 16 B										
a	82										
b	103										
Assembly cut out bulkhead mounted housing	82 x 35										

Han® 24 B		Part-Number	Dimensions in mm								
<p>Han-Kit®-24B</p> <p>Hood¹⁾ Han® 24 B Material Die cast aluminium alloy Protection degree²⁾ IP 65 Cable gland M32, metal Cable diameter 13-20 mm / 18-25 mm Insert Han® 24 E, 24-pins + PE Screw terminal 1-2.5 mm², AWG 18-14 Electrical data accd. to DIN EN 61 984³⁾ 16 A 500 V 6kV 3 Rated current Rated voltage³⁾ Rated impulse voltage Pollution degree Rated voltage accd. to UL/CSA 600 V</p>		10 33 024 0000	<table border="1"> <thead> <tr> <th>Dimensions in mm</th> <th>Han-Kit 24 B</th> </tr> </thead> <tbody> <tr> <td>a</td> <td>108</td> </tr> <tr> <td>b</td> <td>130</td> </tr> <tr> <td>Assembly cut out bulkhead mounted housing</td> <td>108x35</td> </tr> </tbody> </table>	Dimensions in mm	Han-Kit 24 B	a	108	b	130	Assembly cut out bulkhead mounted housing	108x35
Dimensions in mm	Han-Kit 24 B										
a	108										
b	130										
Assembly cut out bulkhead mounted housing	108x35										

1) Bulkhead mounted housing with flange gasket
 2) Protection degree acc. to DIN EN 60 529 in locked position
 3) For use in a un-grounded circuit or a grounded delta circuit

Product Range

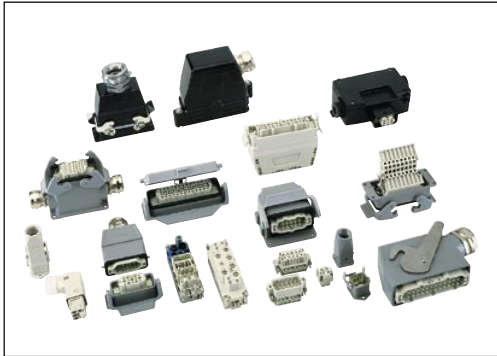

Industrial Connectors Han®



Feldbus components
Sensor/Actuator components
Han-InduNet® system cables

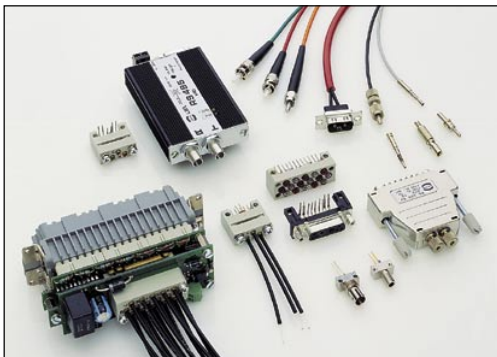

Fiber optic data link systems
and components



Network components
for industrial communication

Subsidiary companies – worldwide



Austria: HARTING Ges. m. b. H.
Deutschstraße 3, A-1230 Wien
Phone +431/6162121; Fax +431/6162121-21
E-Mail: at@HARTING.com

Belgium: HARTING N.V./S.A.
Doornveld 8, B-1731 Zellik
Phone +322/4660190, Fax +322/4667855
E-Mail: be@HARTING.com

Brazil: HARTING Ltda.
Av. Dr. Lino de Moraes Leme, 255; Pq. Jabaquara
CEP 04360-001 - São Paulo - SP - Brazil
Phone +5511/5034-0073; Fax +5511/5034-4743
E-Mail: br@HARTING.com

China: HARTING (HK) Limited
Shanghai Representative Office
Room 2302 Hong Kong Plaza South Tower
283 Huai Hai Road (M); Shanghai 200021, China
Phone +86 21-6390-6935, 6390-6936
Fax +86 21-6390-6399
E-Mail: ChinaSales@HARTING.com.cn

Czech Republic: HARTING spol. s.r.o.
Mlýnská 2, 16000 Praha 6
Phone +4202/20380450; Fax +4202/20380451
E-Mail: HARTING@HARTING.cz
Internet: www.HARTING.cz

Finland: HARTING Oy
Hakamäenkuja 11 A, FIN-01510 Vantaa
Phone +358 9 350 87 300, Fax +358935087320
E-Mail: fi@HARTING.com

France: HARTING France, Paris Nord 2
B.P.60058 Tremblay en France, 181, av. des Nations
F-95972 Roissy Charles de Gaulle Cédex
Phone +33149383400; Fax +33148632306
E-Mail: fr@HARTING.com

Germany: HARTING Deutschland GmbH & Co. KG
Simeons carré 1, D-32427 Minden
Phone +49571/8896-0; Fax +49571/8896-282
E-Mail: de.sales@HARTING.com

Great Britain: HARTING Ltd.
Caswell Road, Brackmills Industrial Estate
GB-Northampton, NN4 7PW
Phone +441604/766686, 827500; Fax +441604/706777
E-Mail: gb@HARTING.com
Internet: www.HARTING.co.uk

Hong Kong: HARTING (HK) Limited
Regional Office Asia Pacific
4208 Metroplaza Tower 1, 223 Hing Fong Road
Kwai Fong, N. T., Hong Kong
Phone +852/2423-7338, Fax +852/2480-4378
E-Mail: AsiaPacific@HARTING.com.hk

Italy: HARTING SpA
Via Dell' Industria 7
I-20090 Vimodrone (Milano)
Phone +3902/250801, Fax +3902/2650597
E-Mail: it@HARTING.com

Japan: HARTING K. K.
Yusen Shin-Yokohama 1 Chome Bldg., 2F
1-7-9, Shin-Yokohama, Kohoku-ku, Yokohama
222-0033 Japan
Tel: +81 45 476 3456; Fax: +81 45 476 3466
E-Mail: JapanSales@HARTING.com
Internet: www.HARTING.co.jp

Korea: HARTING Korea Limited
14/F FKI Building, 28-1 Yoido-dong
Youngdungpo-Gu, Seoul 150-756, Korea
Phone +82 2-784-4614, 784-4615
Fax +82 2-3776-0070
E-Mail: KoreaSales@HARTING.co.kr

Netherlands: HARTING B.V.
Larenweg 44, NL-5234 KA, s-Hertogenbosch
Postbus 3526, NL-5203 DM, s-Hertogenbosch
Phone +3173/6410404; Fax +3173/6440699
E-Mail: verkoop.nl@HARTING.com

Norway: HARTING A/S
Østensjøveien 36, N-0667 Oslo
Phone +4722/700555; Fax +4722/700570
E-Mail: no@HARTING.com

Portugal: HARTING Iberia S.A.
Josep Tarradellas 20-30 4^o 6^a; E-08029 Barcelona
Phone +34 933 638 475; Fax +34 934 199 585
E-Mail: es@HARTING.com

Russia: HARTING ZAO
ul. Tobolskaja 12
Saint Petersburg, 194044 Russia
Phone +7/812/3276477; Fax +7/812/3276478
E-Mail: info@HARTING.ru
Internet: www.HARTING.ru

Singapore: HARTING Singapore Pte Ltd.
No. 1 Coleman Street, #B1-21 The Adelphi
Singapore 179803
Phone +6562255285, Fax +6562259947
E-Mail: SEAsiaSales@HARTING.com.my

Spain: HARTING Iberia S.A.
Josep Tarradellas 20-30 4^o 6^a; E-08029 Barcelona
Phone +34 933 638 475; Fax +34 934 199 585
E-Mail: es@HARTING.com

Sweden: HARTING AB
Gustavslundvägen 141B; S-16751 Bromma
Phone +468/4457171; Fax +468/4457170
E-Mail: se@HARTING.com

Switzerland: HARTING AG
Industriestrasse 26, CH-8604 Volketswil
Phone +4119082060, Fax +4119082069
E-Mail: ch.zh@HARTING.com

Taiwan: HARTING R.O.C. Limited
Room 6, 10 Floor, No. 171
Sung-Te Road, Taipei, Taiwan
Phone +886-2-2346-3177; Fax +886-2-2346-2690
E-Mail: TaiwanSales@HARTING.com.tw

USA: HARTING Inc. of North America
1370 Bowes Road; Elgin, Illinois 60123
Phone +1 847 / 741 1500
Fax +1 847 / 741 8257 (Customer Service)
Fax +1 847 / 717 9420 (Sales+Marketing)
E-Mail: more.info@HARTING.com
Internet: www.HARTING-USA.com

Eastern Europe
HARTING Eastern Europe GmbH
Marienwerderstraße 3, D-32339 Espelkamp
Phone +495772/47-802; Fax +495772/47-90 802
E-Mail: eastern.europe@HARTING.com

Other countries
Please contact your Global Business Unit

Global Business Unit Electric



HARTING Electric GmbH & Co. KG
P.O. Box 1473
D-32328 Espelkamp
Phone +49 57 72/47-97 100
Fax +49 57 72/47-495
E-Mail: HARTING.electric@HARTING.com
Internet: www.HARTING.com

Representatives – worldwide



Argentina: Condel Electronica
Julian Agüero 3355
(1605) Munro - Pcia. de Buenos Aires
Phone + Fax +54 11 4762.0118
E-Mail: mediavicondel@arnet.com.ar
Roberto Mediavilla
Rivera Indarte 390; (5000) Córdoba
Phone +54 351 425-0567, Fax +54 351 421-2282
E-Mail: rmediavilla@arnet.com.ar

Australia
ADILAM Electronics Pty. Ltd.
14 Nicole Close, North Bayswater
3153 Victoria
Phone +61 3 9737 4900
Fax +61 3 9737 4999
E-Mail: mark.c@adilam.com.au
Internet: www.adilam.com.au

Denmark: Knud Wexøe A/S
Skaettekaeret 11, P.O. Box 152
DK-2840 Holte
Phone +45 45 46 58 00, Fax +45 45 46 58 01
wexoe@wexoe.dk; www.wexoe.dk

Finland: SKS-automaatio OY
Martinkyläntie 50, FIN-01721 Vantaa
Phone +358 9 852 661, Fax +358 9 852 68 20
E-Mail: automaatio@sksf.fi

Estonia: SKS-tehnika Ou
Mustamäe tee 55; EE-10621 Tallinn
Phone +372-6819-234, Fax +372-6819-235
peeter.kuus@sksf.fi

Hungary: Mile Kft.
Mádi u. 52; H-1104 Budapest
Phone +36-1-431-9800, Fax +36-1-431-9817
milekft@mile-kft.hu; www.mile-kft.hu

India: Sahajanand Impex Pvt. Ltd.
103/ 104, Magnum Opus
Shantinagar, Vakola Santacruz (East)
Mumbai - 400 055, INDIA
Phone +91-22-5692 5151
Fax +91-22-5692 1026
E-Mail: sales@sahajanand.com
Internet: www.sahajanand.com

Iceland: Smith & Norland
Nóatún 4; IS-105 Reykjavík
Phone +354 520 3000, Fax +354 520 3011
olaf@sminor.is; www.sminor.is

Polen: Soyter Sp. z o. o.
ul. Warszawska 3
05-082 Warszawa - Stare Babice
Phone +48 22 722 0 685
Fax +48 22 722 0 550
handlowy@soyter.com.pl; www.soyter.com

South-Africa
HellermannTyton Pty Ltd.
Private Bag X158 Rivonia 2128
34 Milky Way Avenue
Linbro Business Park 2065
Johannesburg, South Africa
Phone +27 (0)11 879-6600
Fax +27 (0)11 879-6606
E-Mail: sales.jhb@hellermann.co.za

Turkey
Gökhan Elektrik San. Tic. Ltd. Sti.
Perpa Elektrikçiler Is Merkezi A Blok
Kat:7-8-9 No.694
TR - 80270 Okmeydanı/Istanbul
Phone +90 (212) 2 21 32 36 (pbx)
Fax +90 (212) 2 21 32 40
E-Mail: gokhan@gokhanelektrik.com

Your Contact Partner

